

Insecure Transit

Microservice Security

Sam Newman - QCON London 2018

O'REILLY®

Building Microservices

DESIGNING FINE-GRAINED SYSTEMS

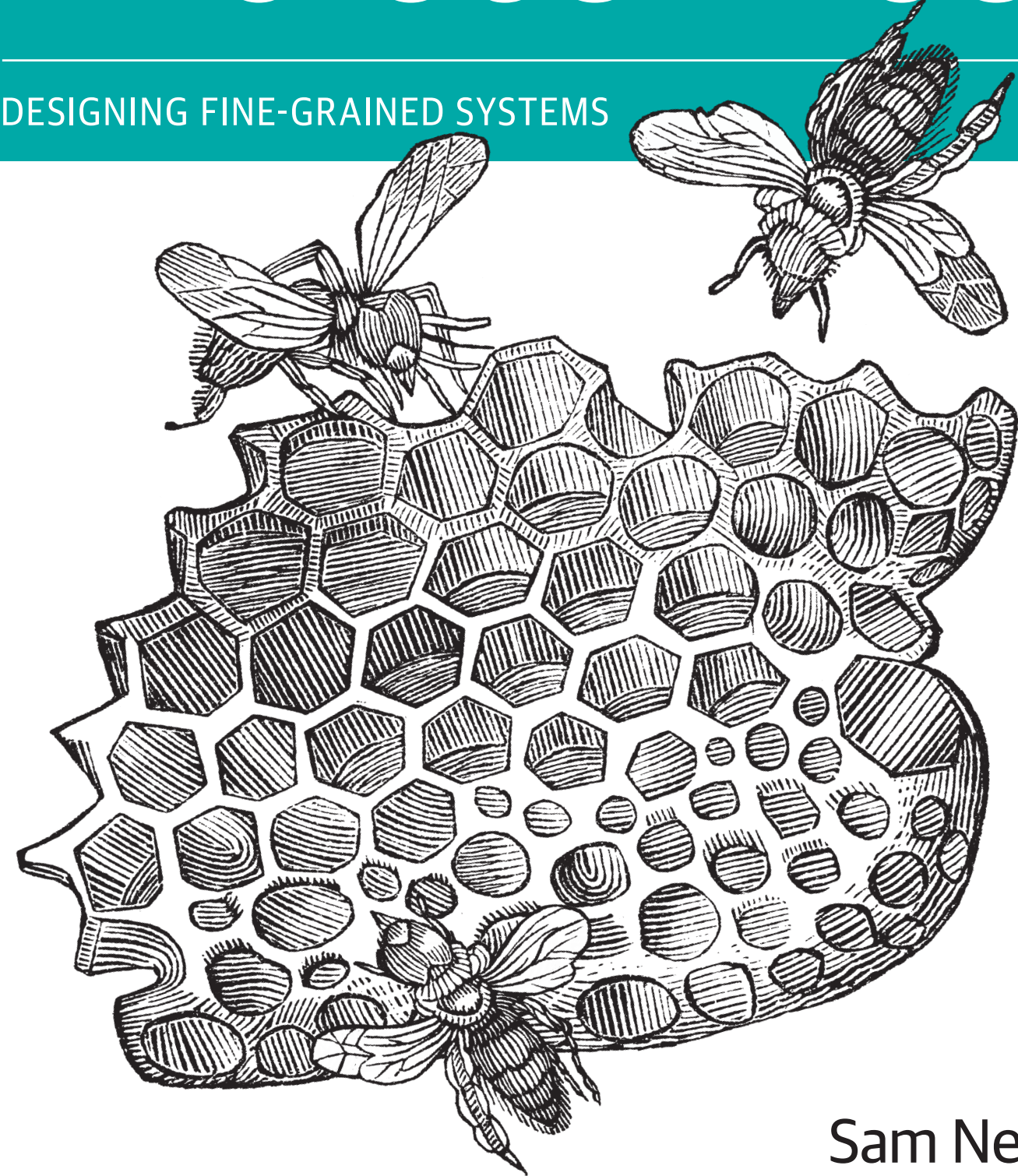

Sam Newman

Sam Newman & Associates

Massive Equifax data breach - what you need to know



By [Callum Mason](#), News Reporter
12 Sep 2017 | Updated 19 Sep 2017



Credit report heavyweight Equifax has warned that up to 400,000 UK consumers may have had their personal details stolen as part of a massive global data breach. Info on exactly who's been affected and what you can do about it is still somewhat sketchy, but here's what we know.

Equifax revealed on 8 September that 143 million consumers in the US could have been affected by the incident, which saw hackers access data such as names, address and dates of birth, as well as credit card numbers in a smaller number of cases.

Although its UK business – Equifax Ltd – now says systems in this country are not affected, it admits a file which was stored in the US and contained more limited personal information on up to 400,000 UK consumers may have been accessed.

Related MSE Guides

[Credit Scores](#)

Bust myths & improve your score

[30+ Ways to Stop Scams](#)

As scams get clever, we need to too!

[Check your credit report for free](#)

Grab your file and check your score, or even get PAID to do it



Get Our Free Money Tips Email!

For all the latest deals, guides and loopholes - join the 12m who get it.

Don't miss out

GET IT!

[FAQs](#) | [Privacy Policy](#) | [Past Emails](#) | [Unsubscribe](#)

What is Equifax and what data does it have?

Equifax is the second biggest credit reference agency in the UK, after Experian.

<https://www.moneysavingexpert.com/news/protect/2017/09/massive-equifax-data-breach---what-you-need-to-know>

Security

Meltdown, Spectre: The password theft bugs at the heart of Intel CPUs

AMD, Arm also affected by data-leak design blunders, Chipzilla hit hardest

By Chris Williams, Editor in Chief 4 Jan 2018 at 07:29

252  SHARE ▼



Summary The severe design flaw in Intel microprocessors that allows sensitive data, such as passwords and crypto-keys, to be stolen from memory is real – and its details have been revealed.

On Tuesday, we warned that a [blueprint blunder in Intel's CPUs](#) could allow applications, malware, and JavaScript running in web browsers, to obtain information they should not be allowed to access: the contents of the operating system kernel's private memory areas. These zones often contain files cached from disk, a view onto the machine's entire physical memory, and other secrets. This should be invisible to normal programs.

https://www.theregister.co.uk/2018/01/04/intel_amd_arm_cpu_vulnerability/

The EU General Data Protection Regulation (GDPR) is the most important change in data privacy regulation in 20 years - we're here to make sure you're prepared.



GDPR Portal: Site Overview

This website is a resource to educate the public about the main elements of the General Data Protection Regulation (GDPR)

After four years of preparation and debate the GDPR was finally approved by the EU Parliament on 14 April 2016. Enforcement date: 25 May 2018 - at which time those organizations in non-compliance may face heavy fines.

The EU General Data Protection Regulation (GDPR) replaces the Data Protection Directive 95/46/EC and was designed to harmonize data privacy laws across Europe, to protect and empower all EU citizens data privacy and to reshape the way organizations across the region approach data privacy. The key articles of the GDPR, as well as information on its business impact, can be found throughout this site.

Quick Links

GDPR Key Changes
Summary of key changes

FAQs
How to prepare?
Is my organization affected?
What does Brexit mean for GDPR?

<https://www.eugdpr.org>

Design

Design

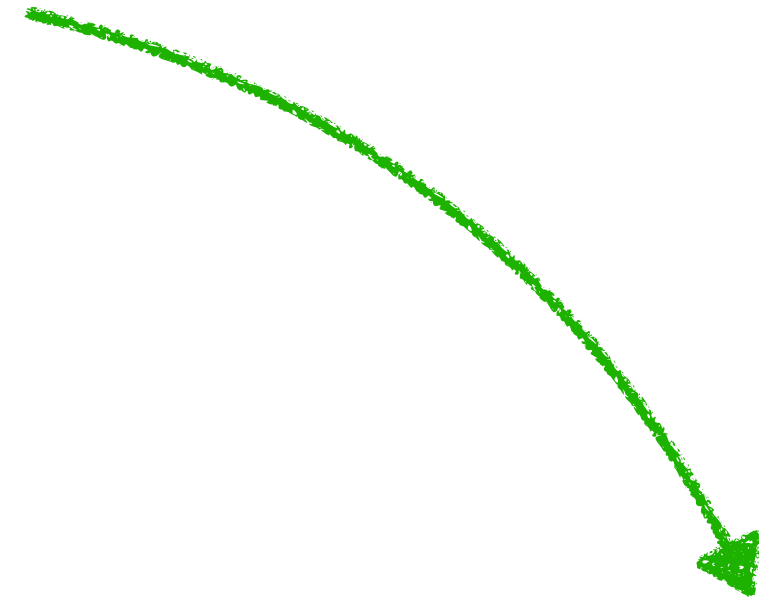

Develop

Design



Develop

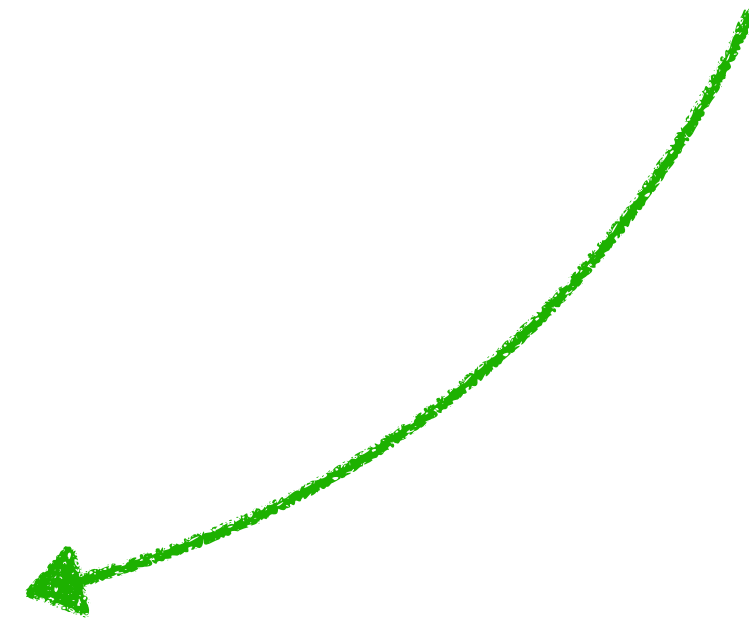

Test

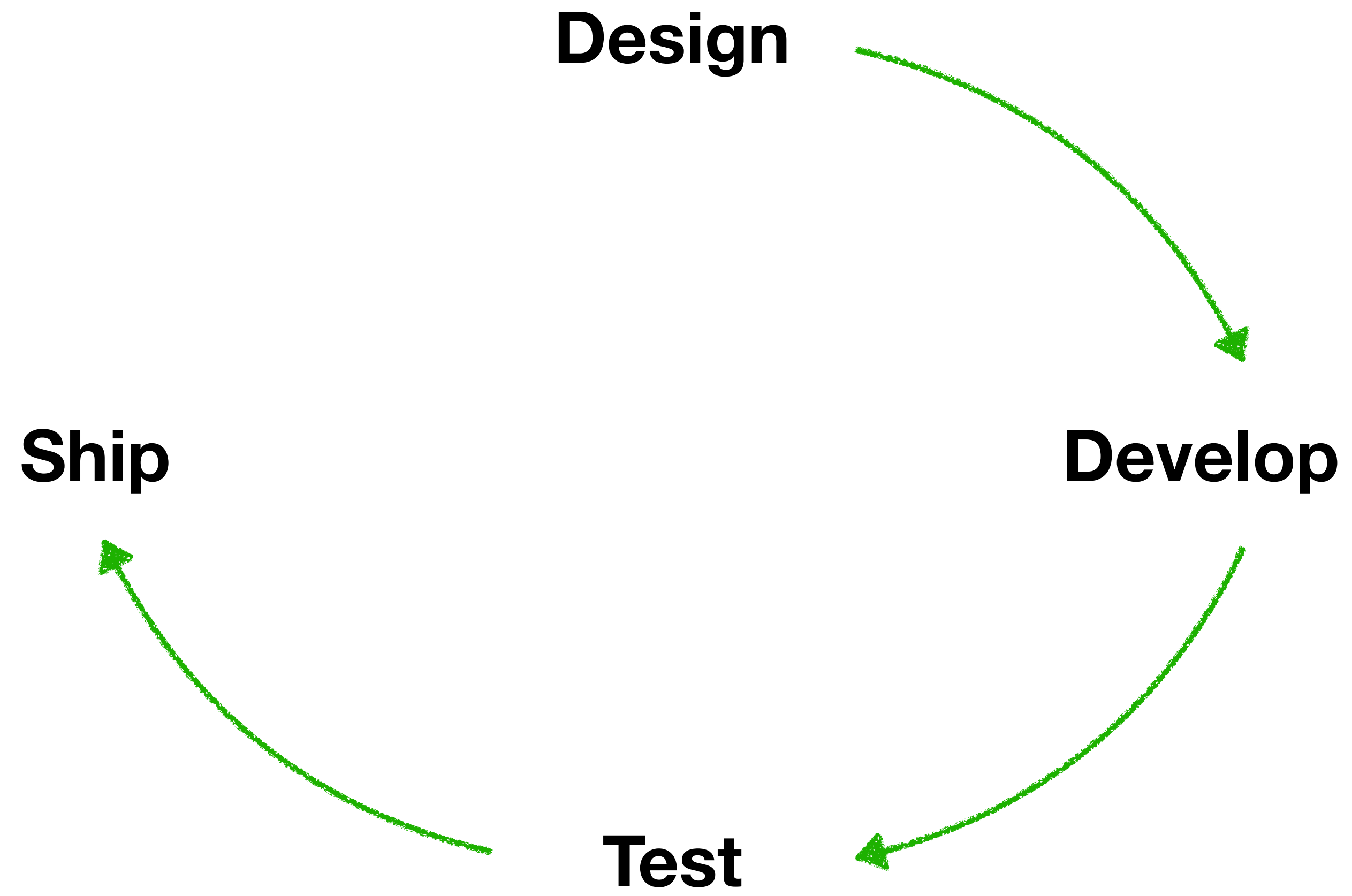

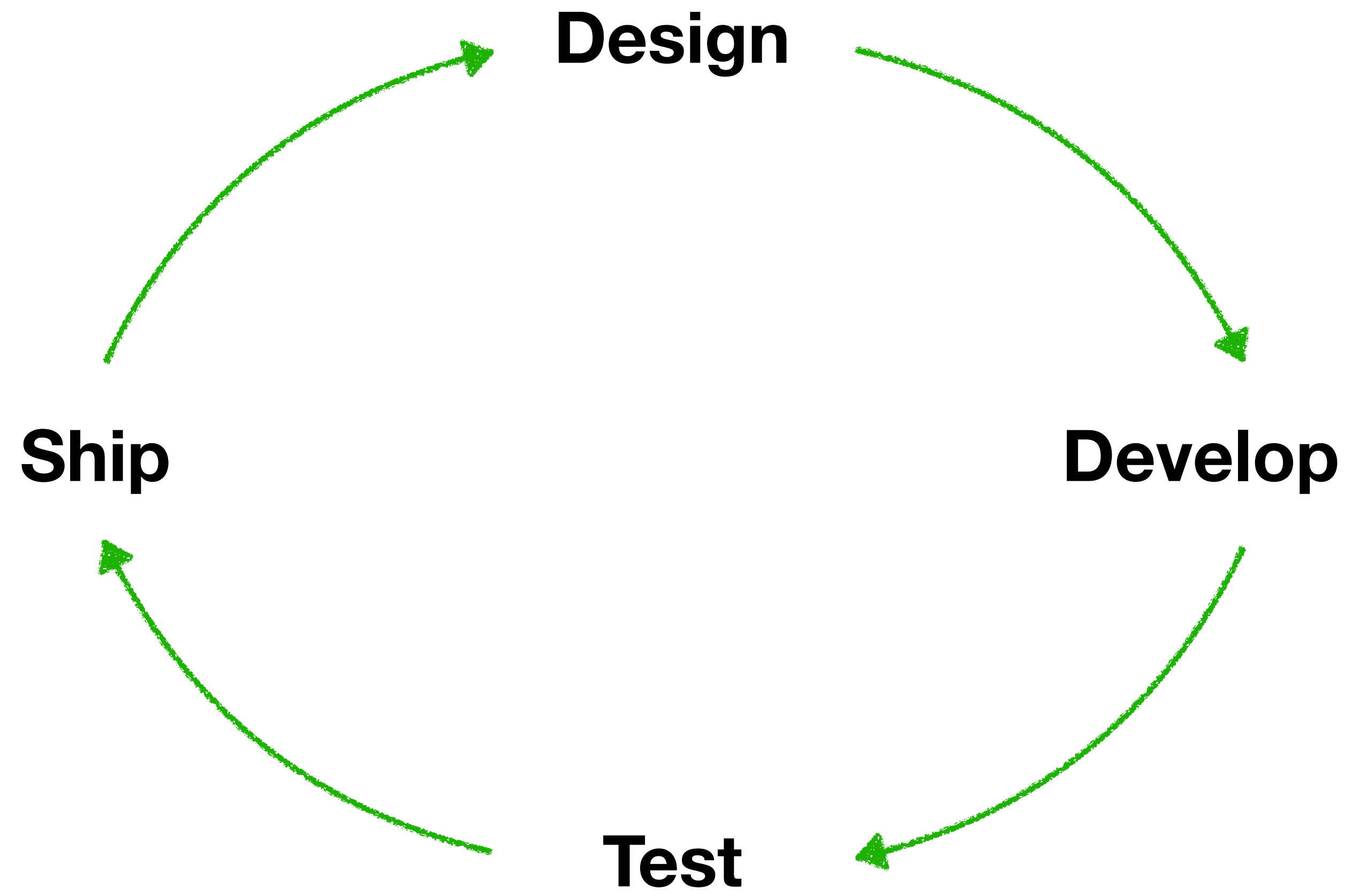

Err ... security?

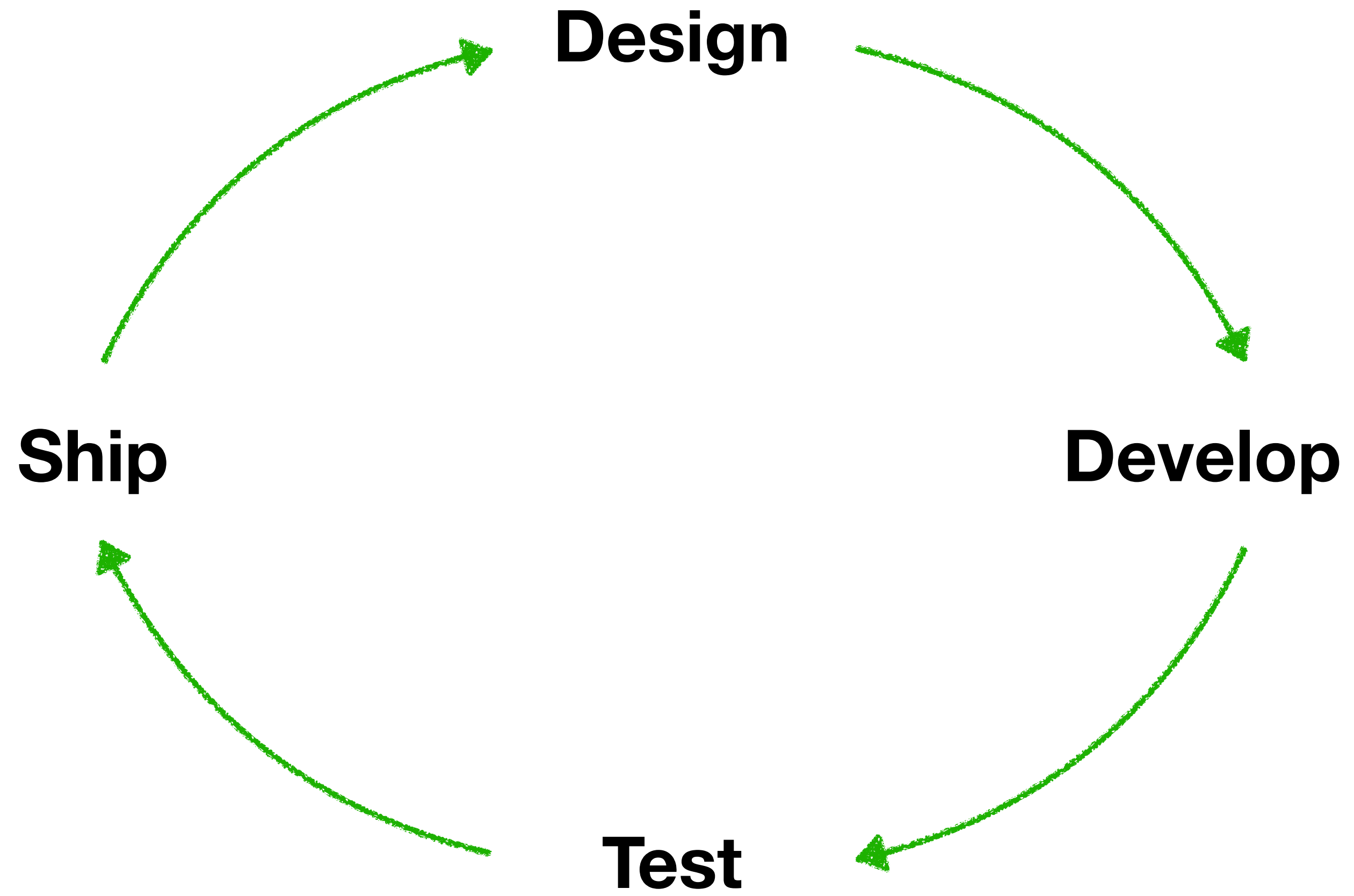





Just Enough Security

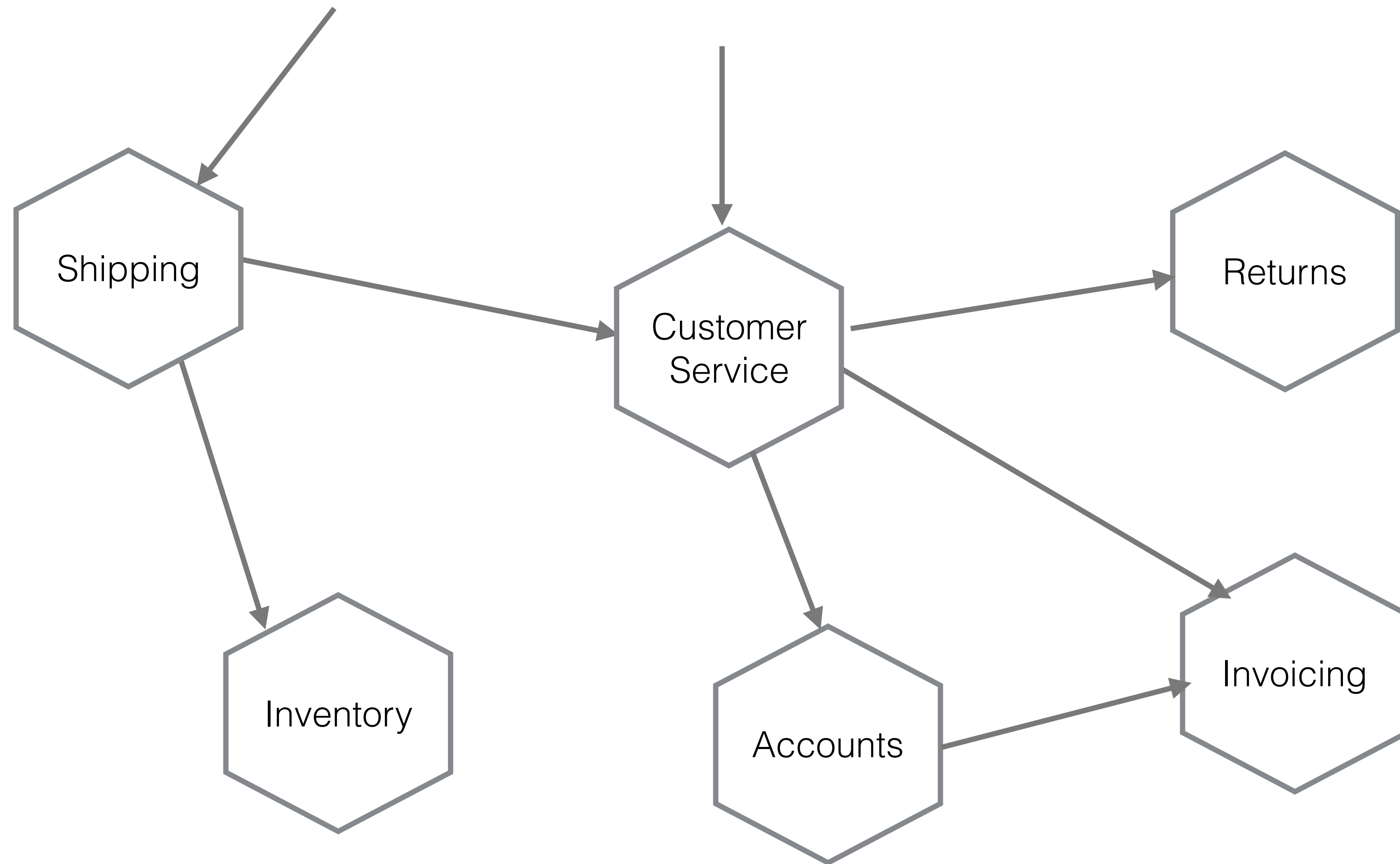

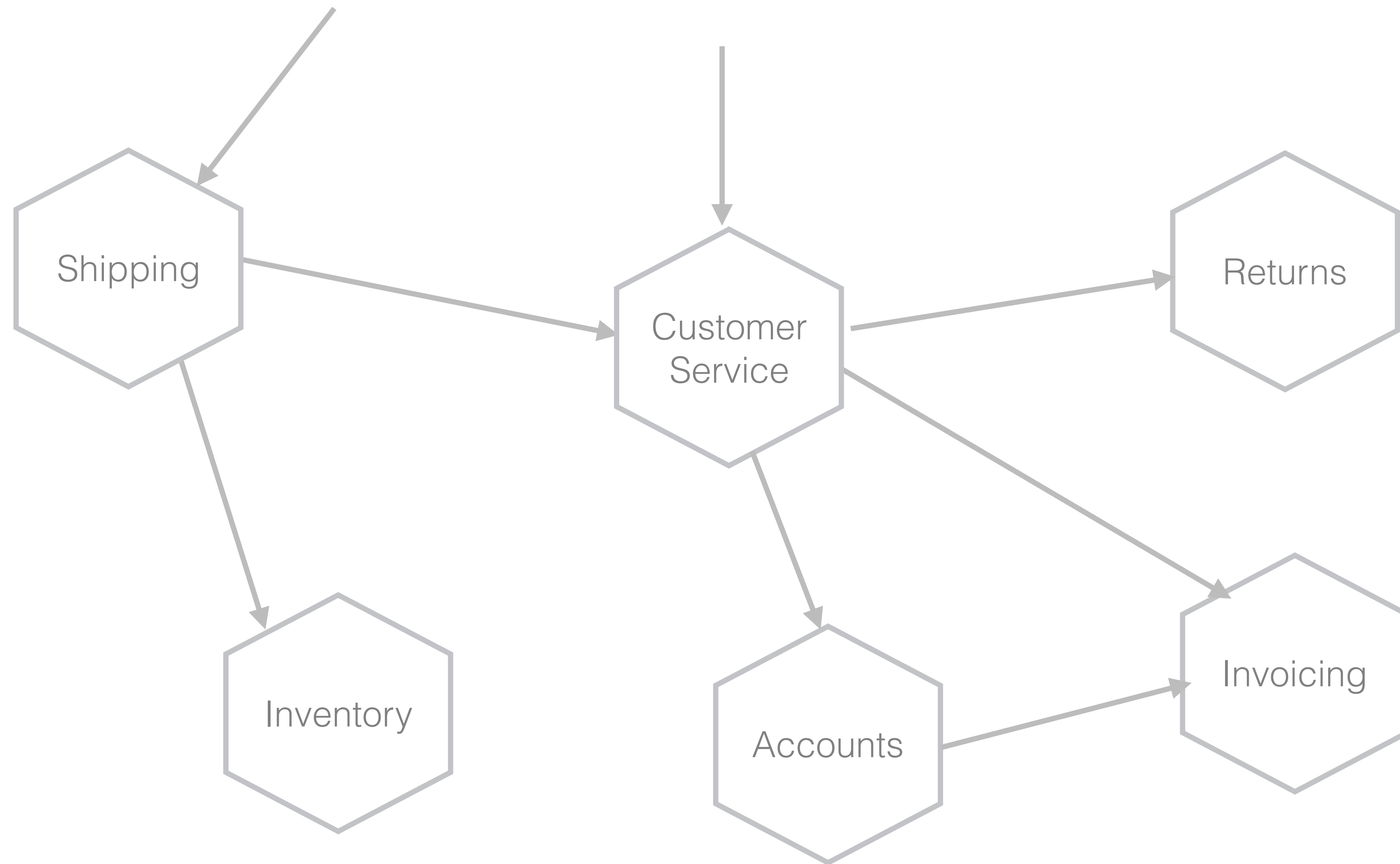

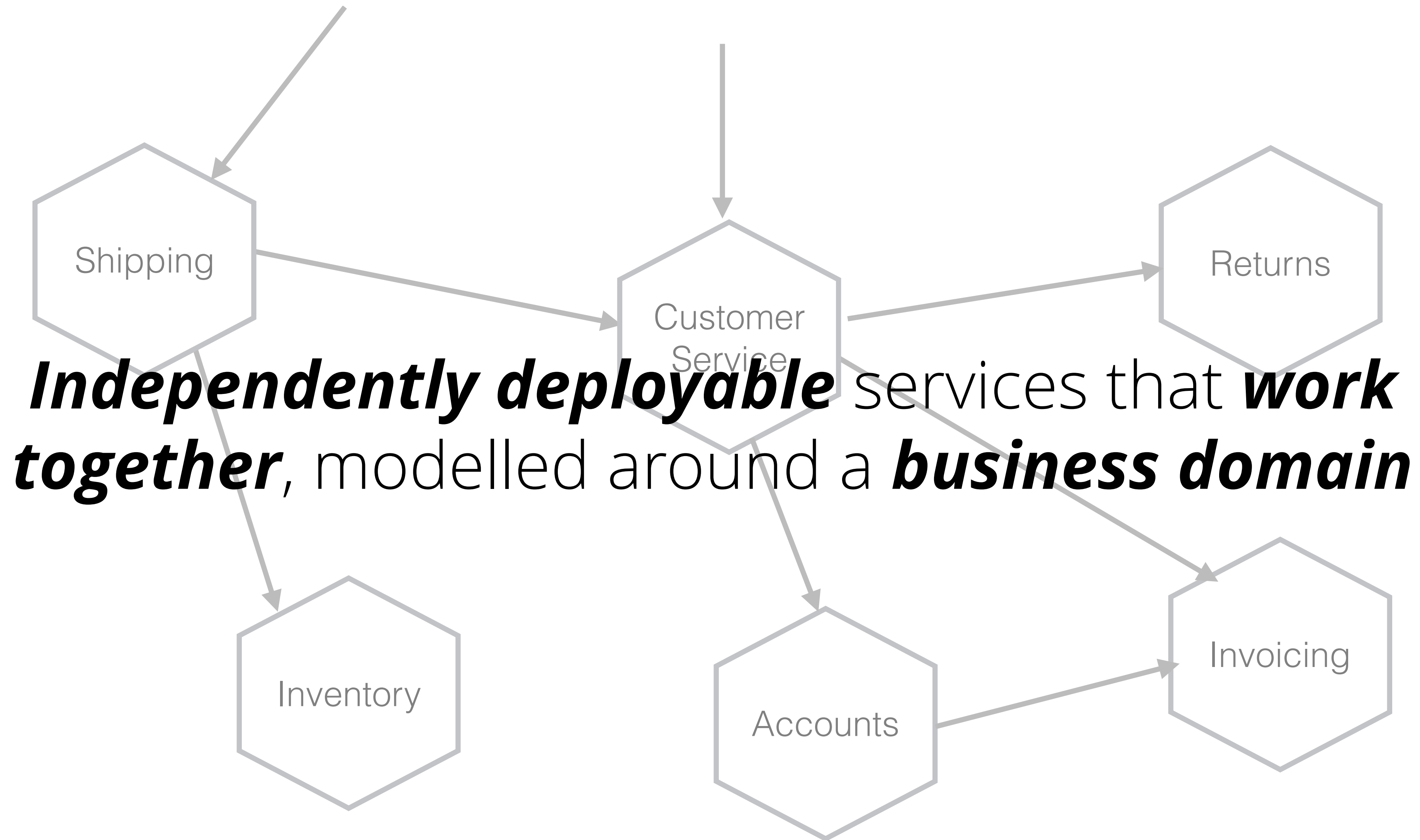



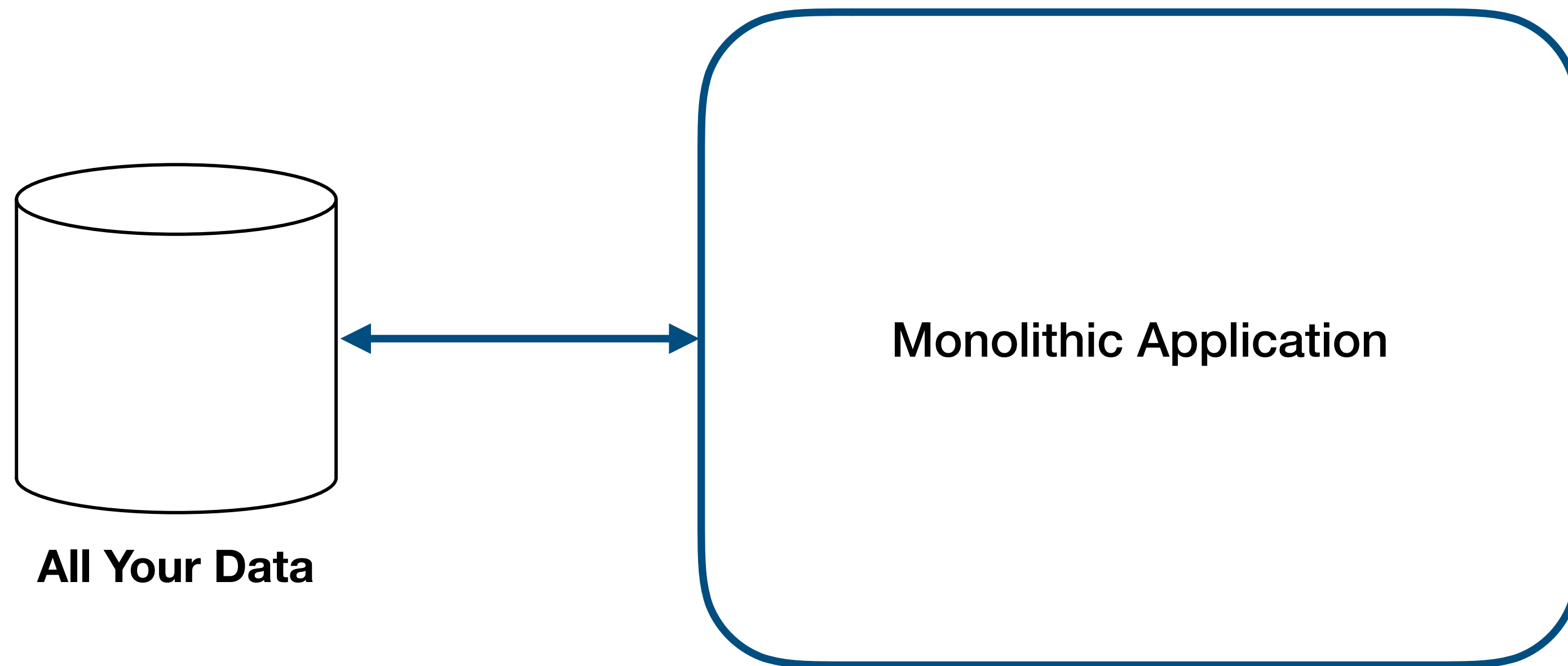



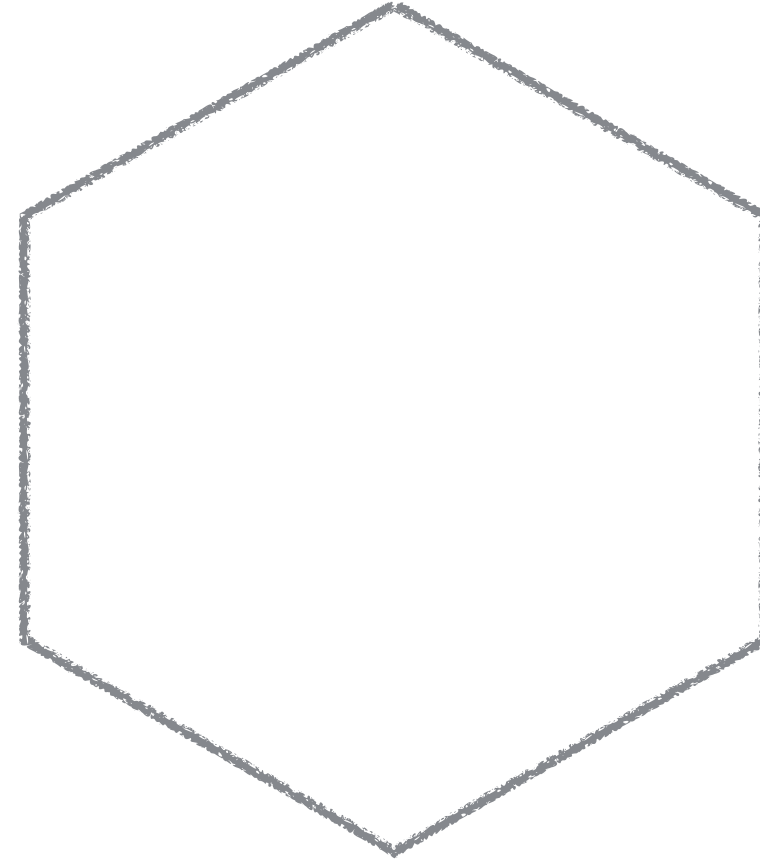
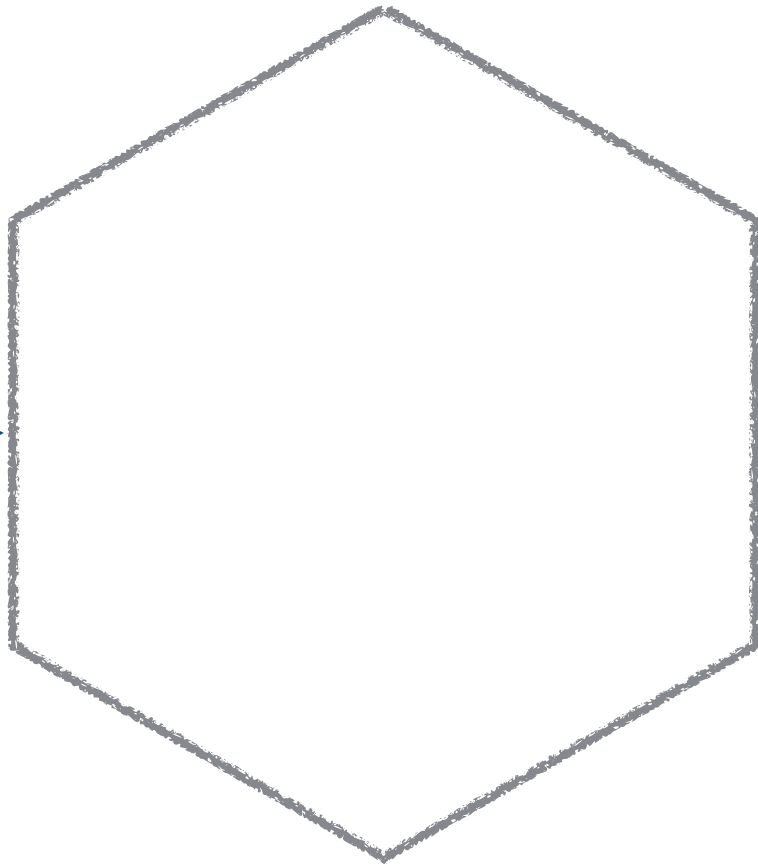
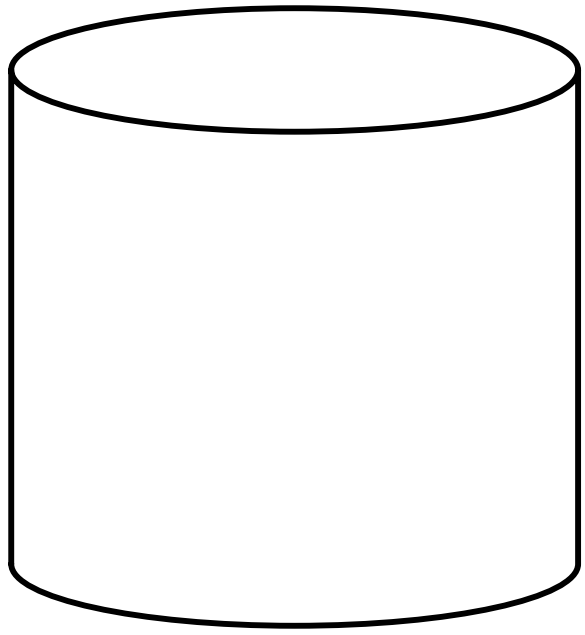
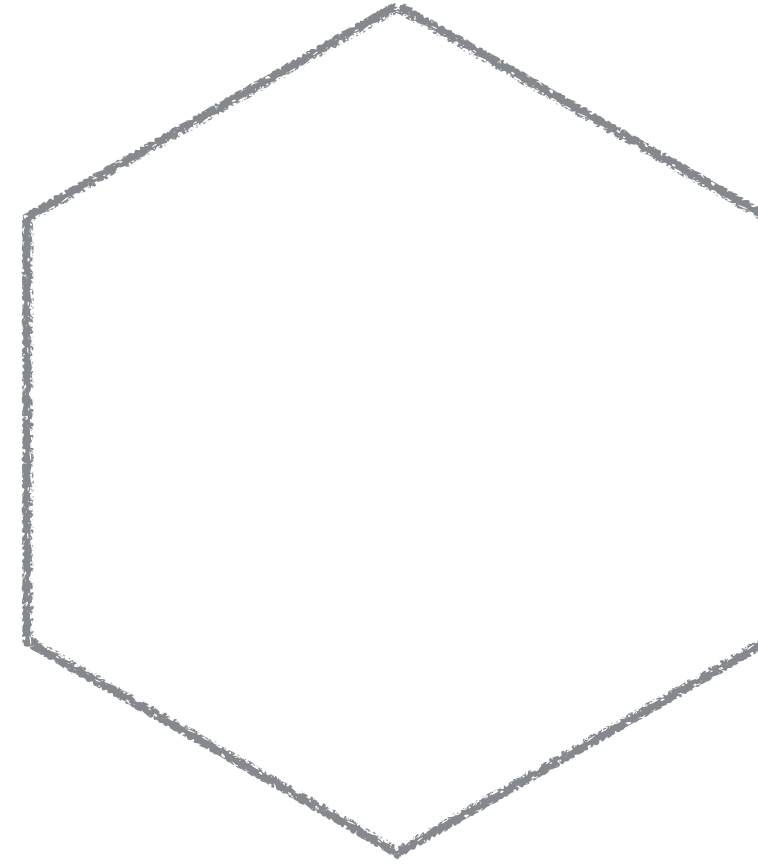
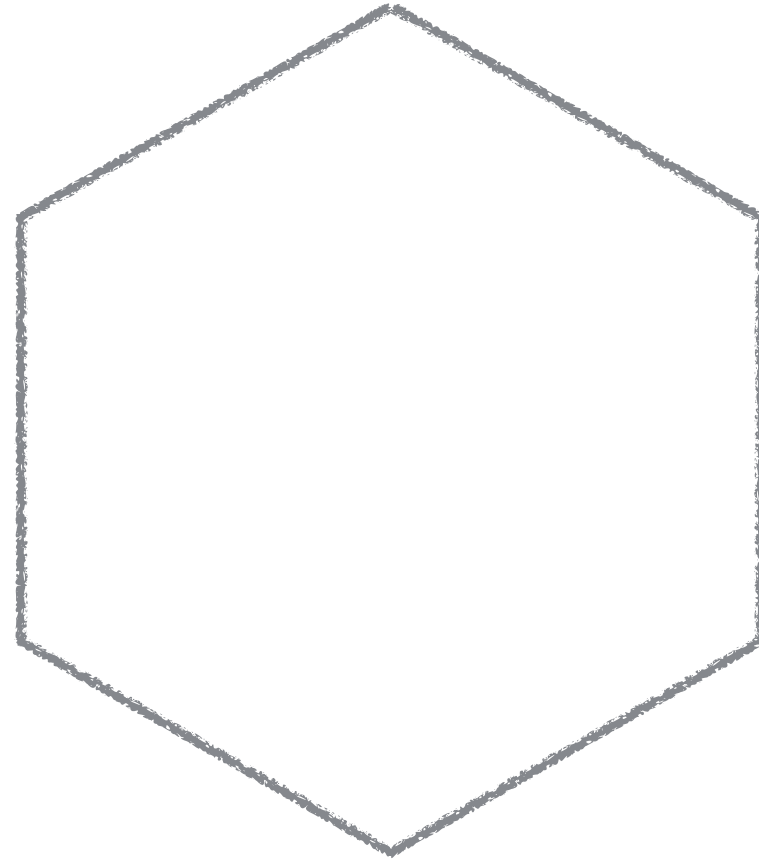
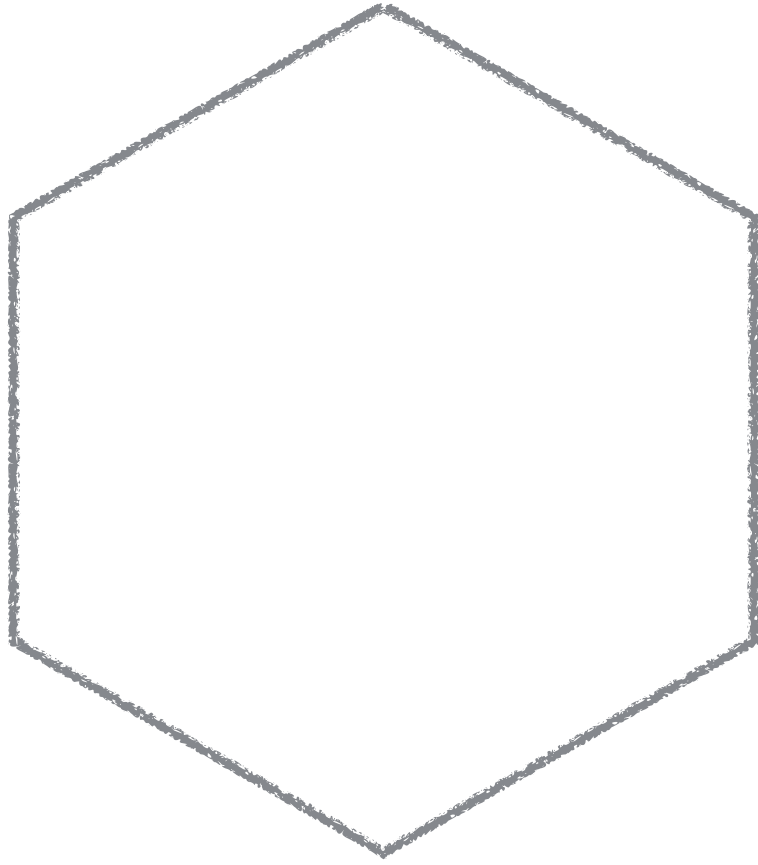

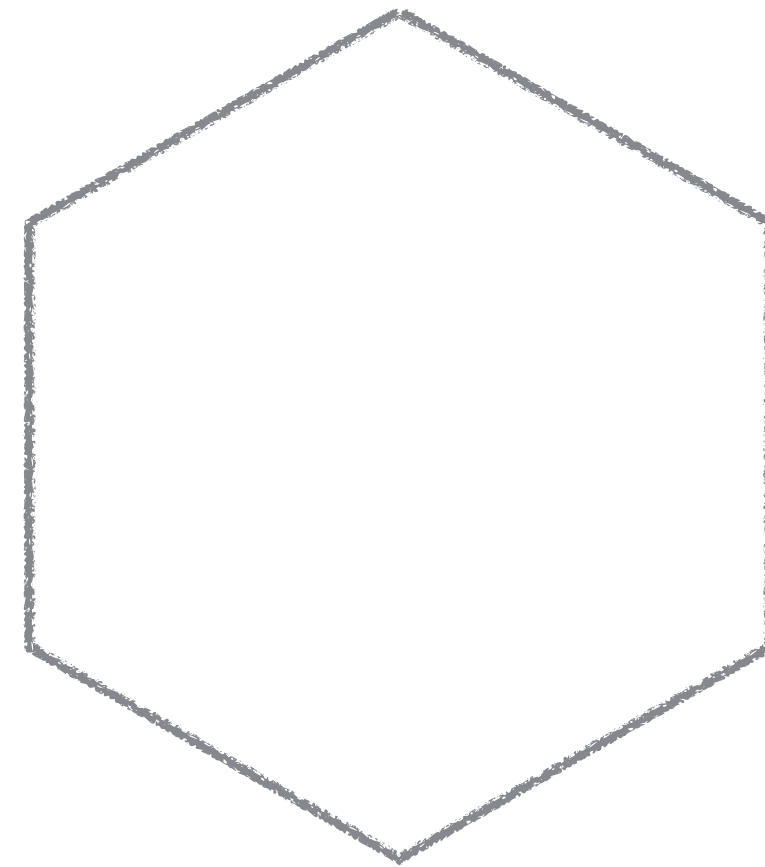
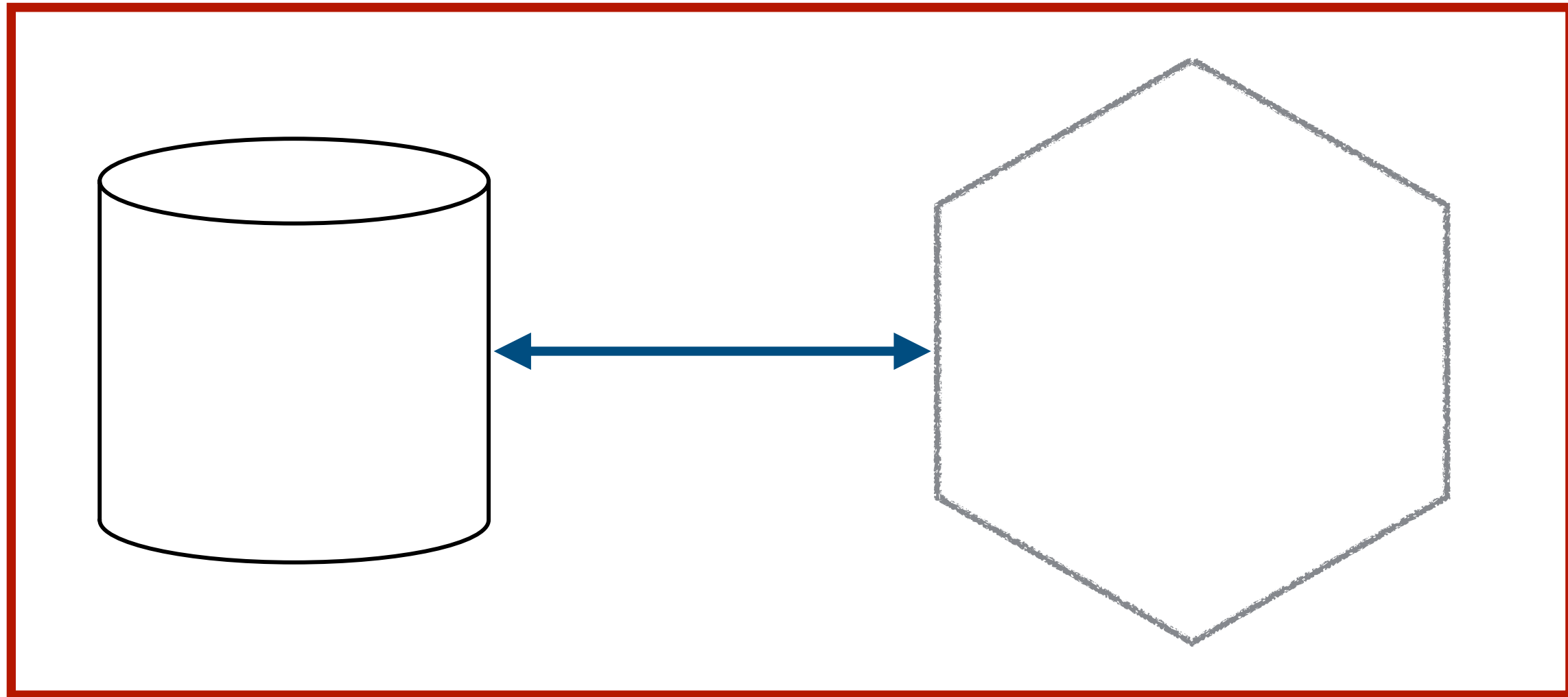
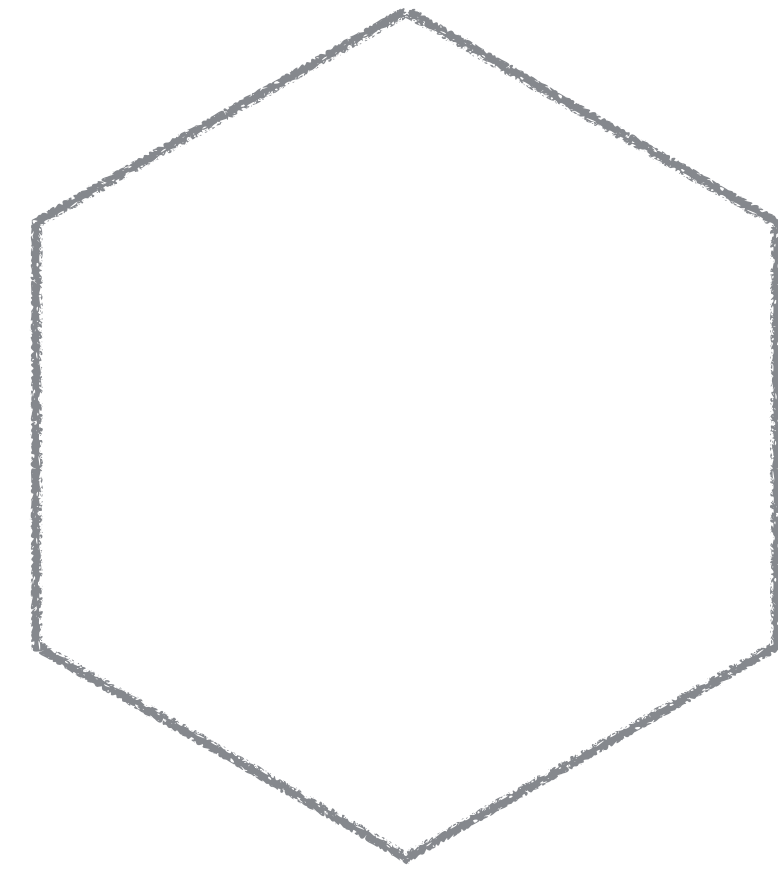
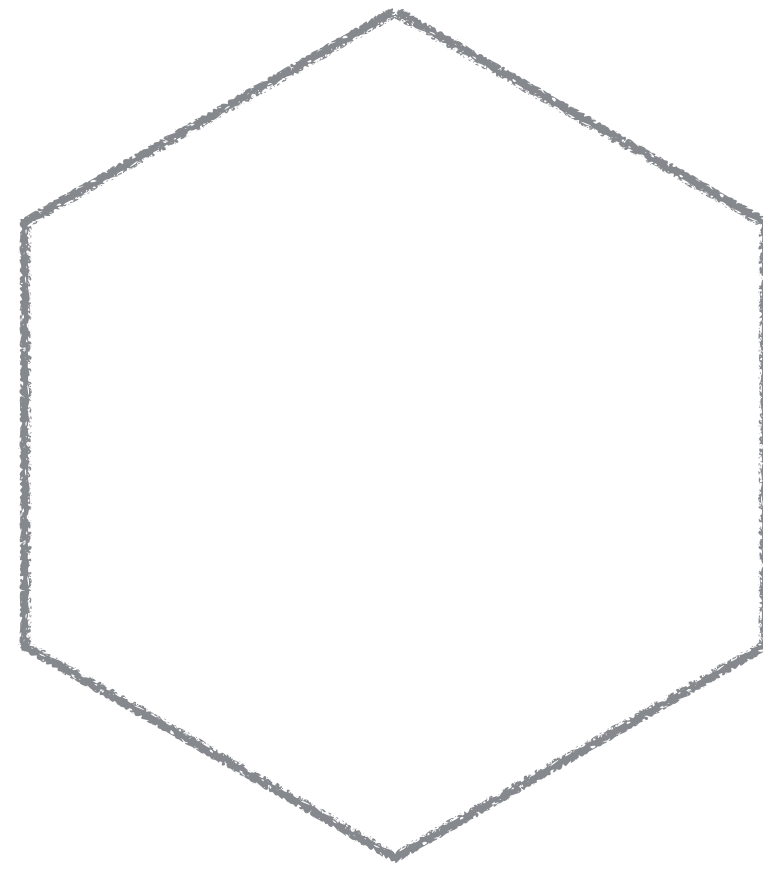
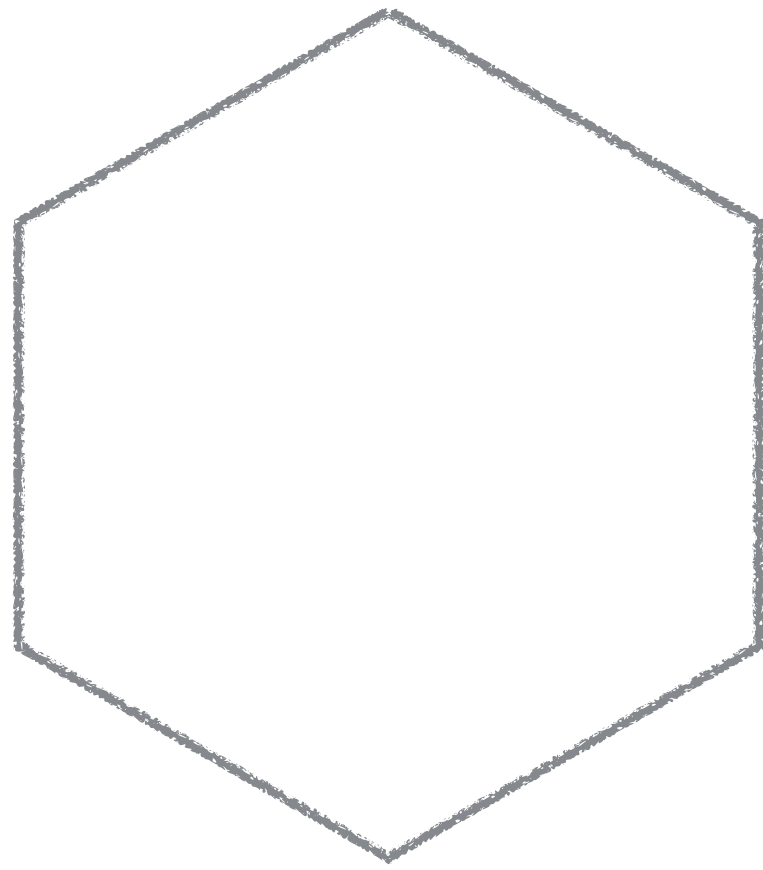



For organisations /

Guide to the General Data Protection Regulation (GDPR)

Share  Download options 

Search this document 

Introduction

[What's new](#)

[Key definitions](#)

[Principles](#)

[Lawful basis for processing](#)

[Consent](#)

[Legitimate interests](#)

[Special category data](#)

[Criminal offence data](#)

Introduction

The Guide to the GDPR explains the provisions of the GDPR to help organisations comply with its requirements. It is for those who have day-to-day responsibility for data protection.

This is a living document and we are working to expand it in key areas. It includes links to relevant sections of the GDPR itself, to other ICO guidance and to guidance produced by the EU's Article 29 Working Party. The Working Party includes representatives of the data protection authorities from each EU member state, and the ICO is the UK's representative.

Alongside the Guide to the GDPR, we have produced a number of tools to help organisations to prepare for the GDPR:

 [GDPR: 12 steps to take now](#) 

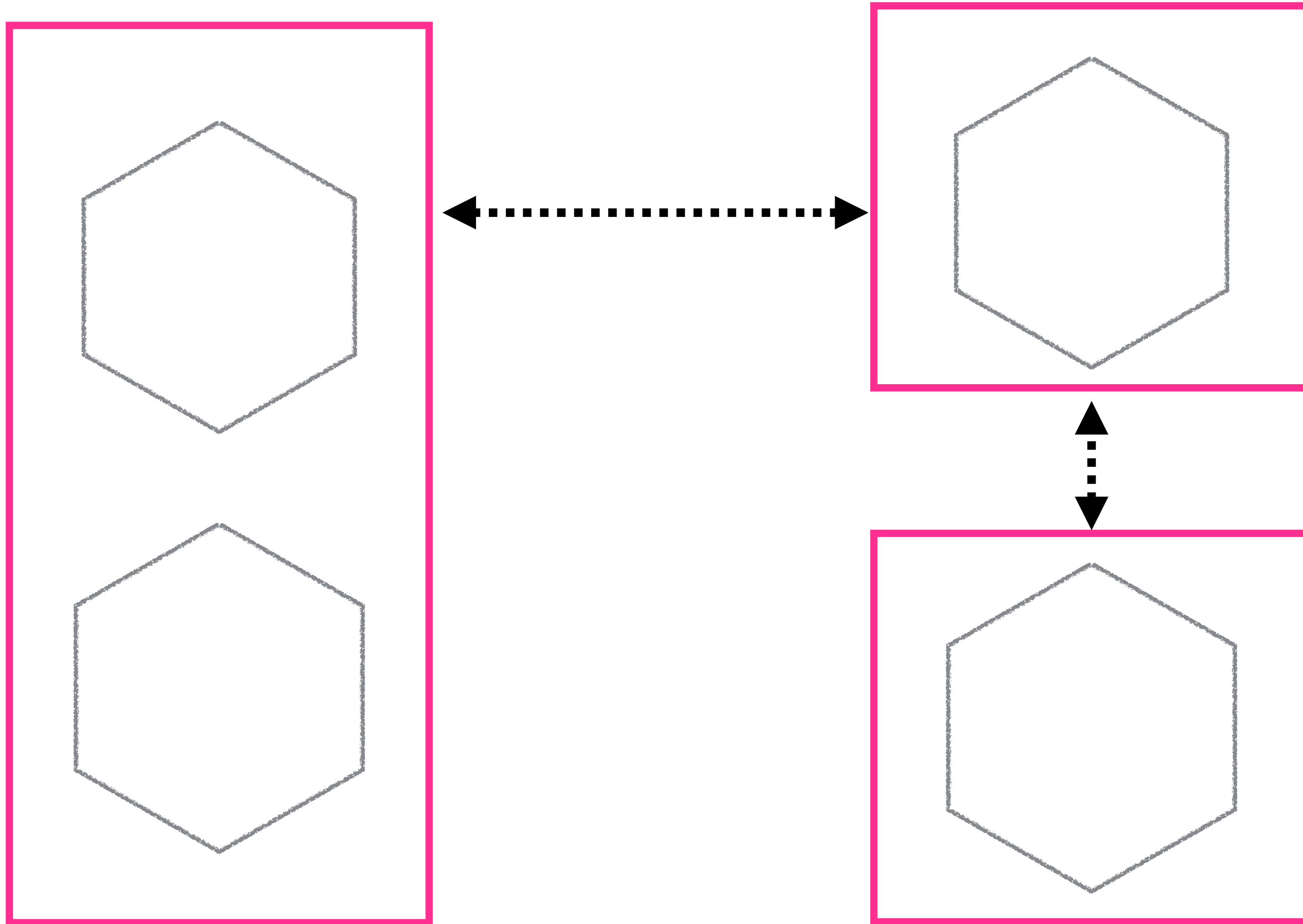

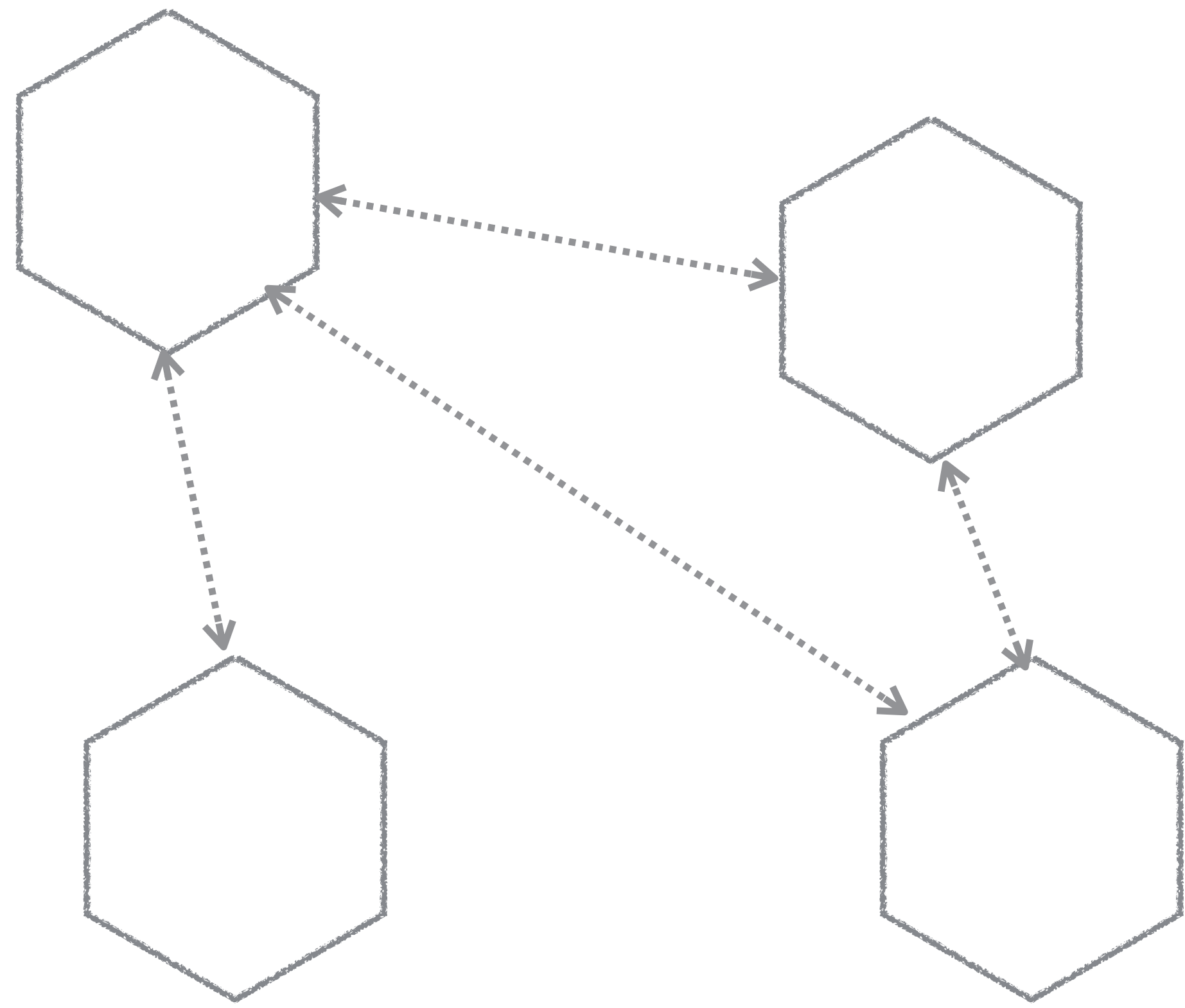

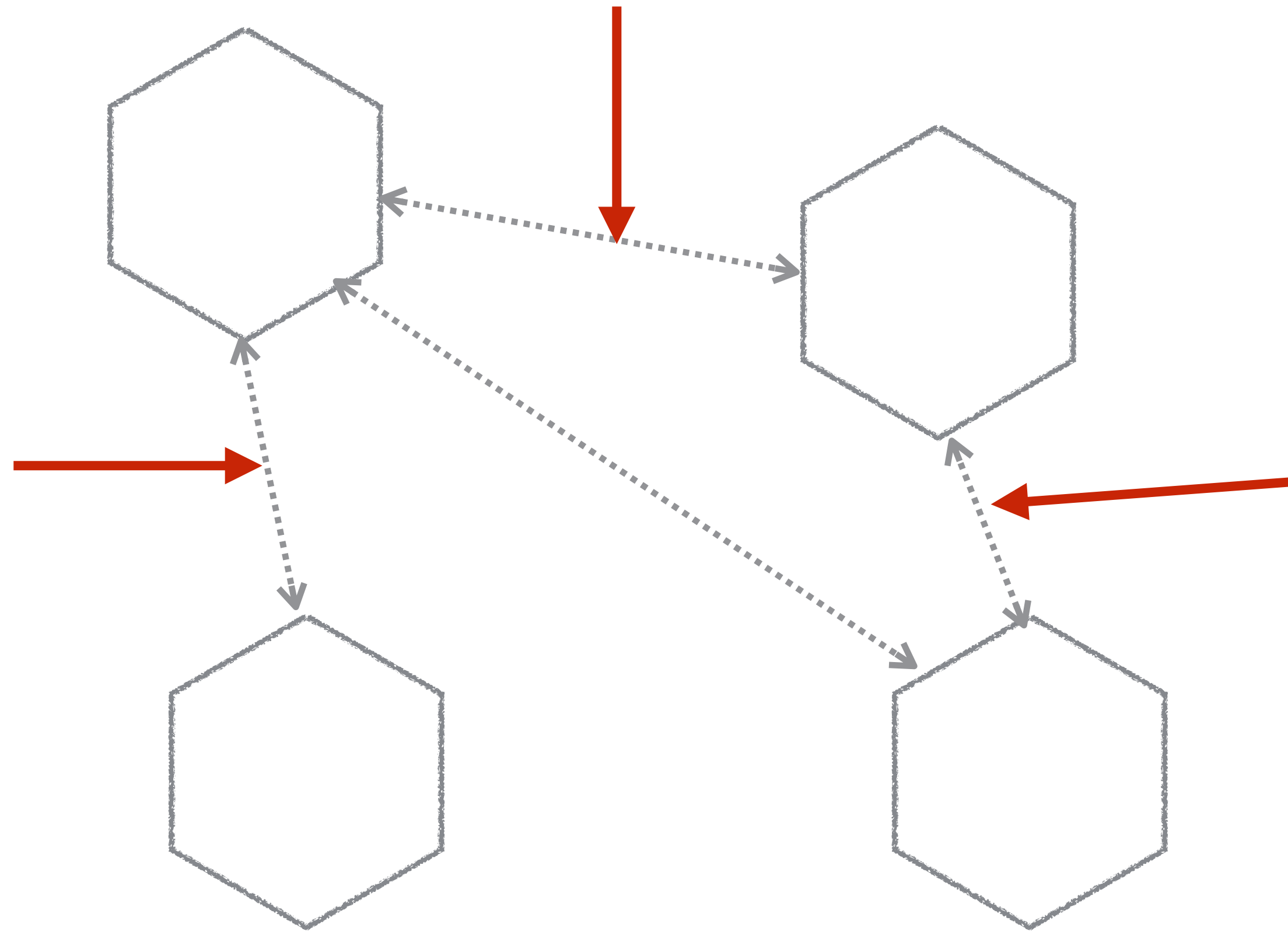

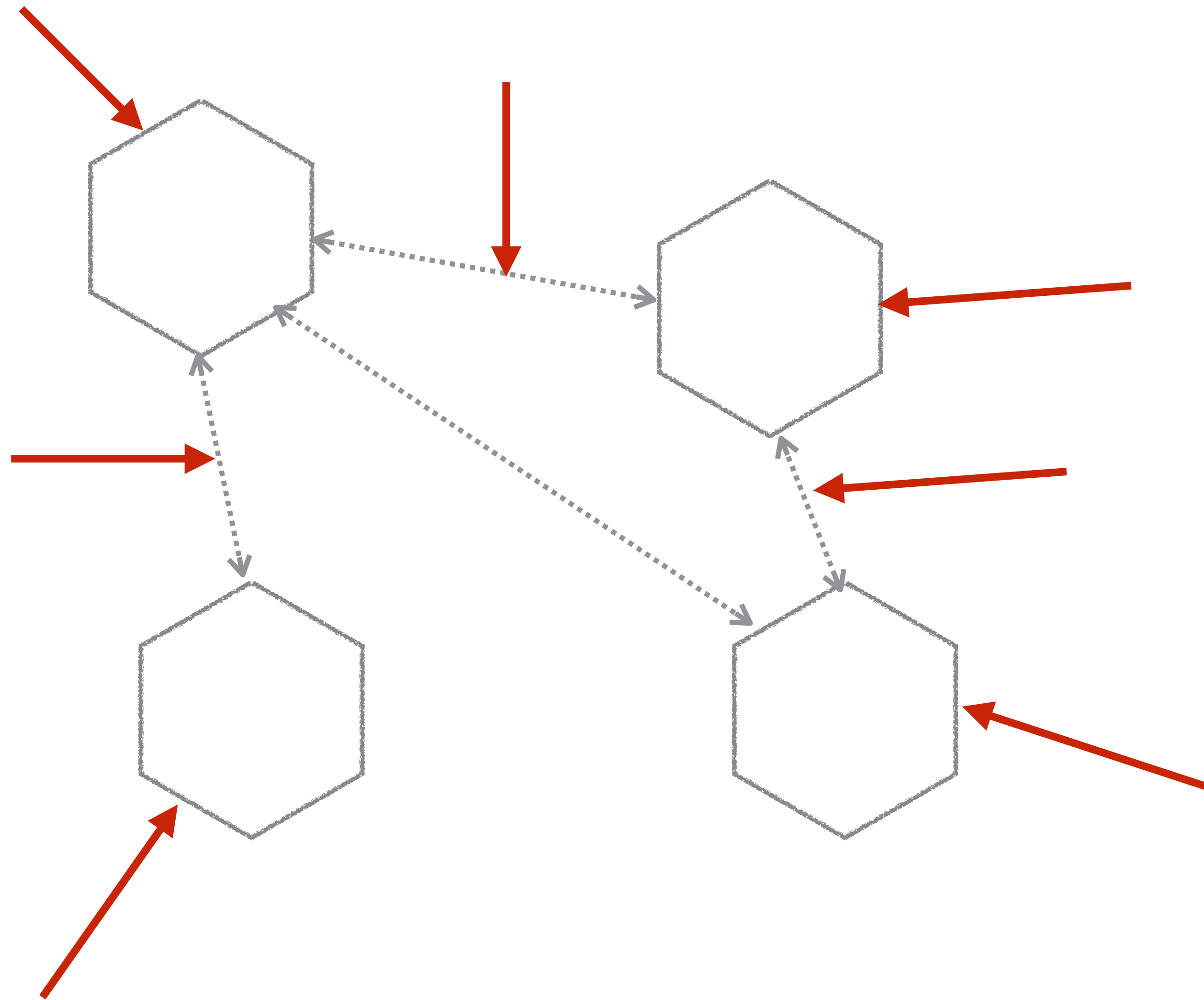

The Basics

Who here thinks they can assess risks?



http://www.verizonenterprise.com/resources/reports/rp_DBIR_2017_Report_en_xg.pdf

HOW DO BREACHES OCCUR?

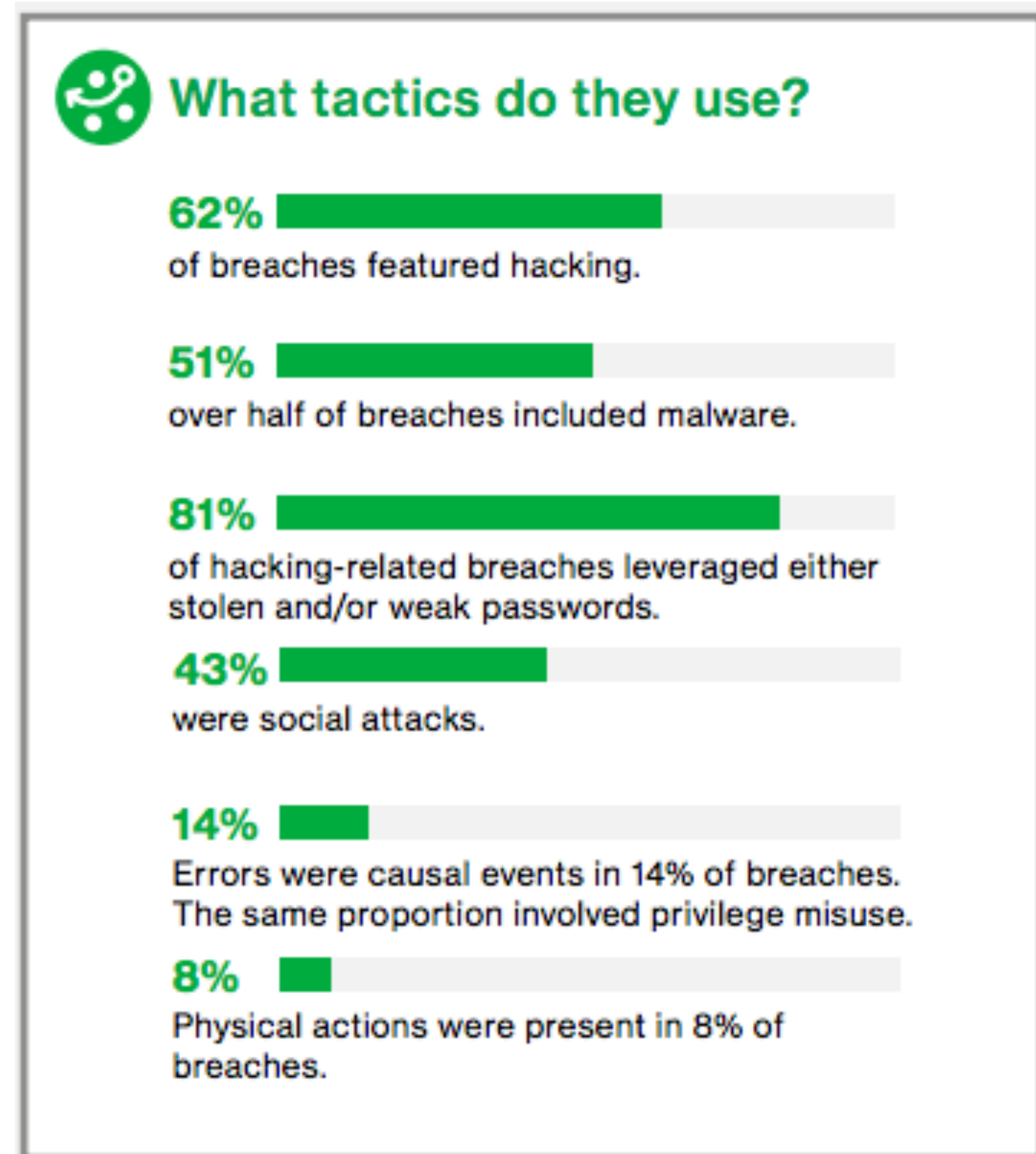

<http://www.verizonenterprise.com/verizon-insights-lab/dbir/2017/>

HOW DO BREACHES OCCUR?

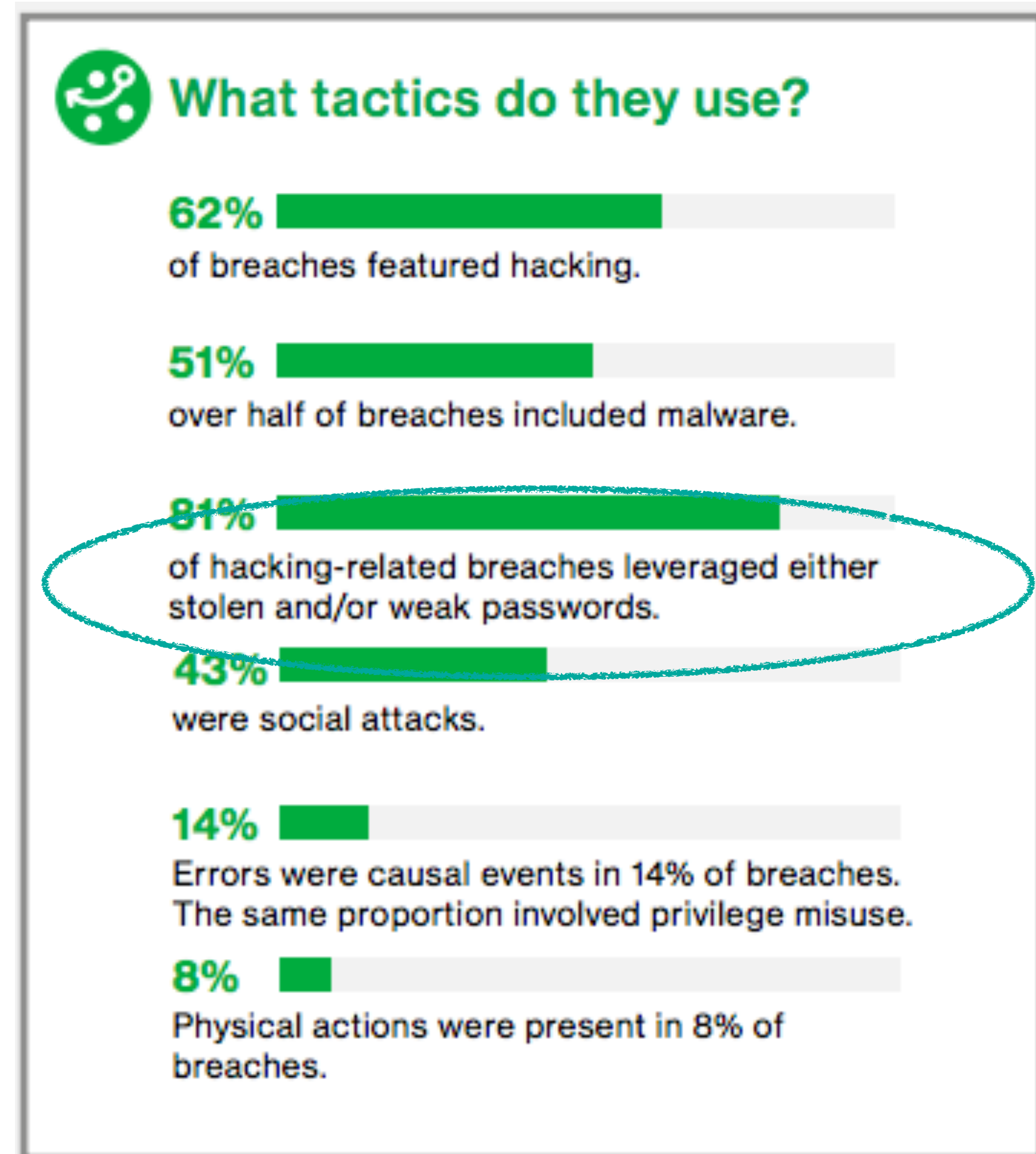

<http://www.verizonenterprise.com/verizon-insights-lab/dbir/2017/>

BETTER PASSWORD RULES?

Passwords Evolved: Authentication Guidance for the Modern Era



26 JULY 2017

In the beginning, things were simple: you had two strings (a username and a password) and if someone knew both of them, they could log in. Easy.

But the ecosystem in which they were used was simple too, for example in [MIT's Time-Sharing Computer](#), considered to be the first computer system to use passwords:



<https://www.troyhunt.com/passwords-evolved-authentication-guidance-for-the-modern-era/>

BETTER PASSWORD RULES?

Passwords Evolved: Authentication Guidance for the Modern Era



26 JULY 2017

In the beginning, things were simple: you had two strings (a username and a password) and if someone knew both of them, they could log in. Easy.

But the ecosystem in which they were used was simple too, for example in [MIT's Time-Sharing Computer](#), considered to be the first computer system to use passwords:



Summarises ideas from NIST
and the UK's National Cyber
Security Centre

<https://www.troyhunt.com/passwords-evolved-authentication-guidance-for-the-modern-era/>

BETTER PASSWORD RULES?

Passwords Evolved: Authentication Guidance for the Modern Era



26 JULY 2017

In the beginning, things were simple: you had two strings (a username and a password) and if someone knew both of them, they could log in. Easy.

But the ecosystem in which they were used was simple too, for example in [MIT's Time-Sharing Computer](#), considered to be the first computer system to use passwords:



Summarises ideas from NIST
and the UK's National Cyber
Security Centre

Packed with great tips, like...

<https://www.troyhunt.com/passwords-evolved-authentication-guidance-for-the-modern-era/>

PASSWORDS EVOLVED

<https://www.troyhunt.com/passwords-evolved-authentication-guidance-for-the-modern-era/>

PASSWORDS EVOLVED

Longer is stronger

PASSWORDS EVOLVED

Longer is stronger

Eliminate complex character composition rules

Send ...

Save

"Sorry that password won't work, you must include: a symbol, a number, a hieroglyph, a gang sign, an inspiring quote, a poem that you just wrote, a picture of your favorite animal made using only characters on your keyboard, and an uppercase letter."

B Saved from
blurbsbybrenda.blogspot.com

Visit

<https://www.pinterest.dk/pin/566679565591724157/>

PASSWORDS EVOLVED

Longer is stronger

Eliminate complex character composition rules

PASSWORDS EVOLVED

Longer is stronger

Eliminate complex character composition rules

Embrace password managers

PASSWORDS EVOLVED

Longer is stronger

Eliminate complex character composition rules

Embrace password managers

Do not mandate password changes

PASSWORDS EVOLVED

Longer is stronger

Eliminate complex character composition rules

Embrace password managers

Do not mandate password changes

Block previously breached passwords

CHECK FOR BREACHED PASSWORDS!

Downloading the Pwned Passwords list

The entire set of passwords is downloadable for free below with each password being represented as a SHA-1 hash to protect the original value (some passwords contain personally identifiable information) followed by a count of how many times that password had been seen in the source data breaches. The list may be integrated into other systems and used to verify whether a password has previously appeared in a data breach after which a system may warn the user or even block the password outright. For suggestions on integration practices, [read the Pwned Passwords launch blog post](#) for more information.

Please download the data via the torrent link if possible! If you can't access torrents (for example, they're blocked by a corporate firewall), use the "Cloudflare" link and they'll kindly cover the bandwidth cost.

	File	Date	Size	Description	SHA-1 hash of 7-Zip file
torrent cloudflare	Version 2 (ordered by prevalence)	22 Feb 2018	8.8GB	Version 2 with 501m hashes and counts of password usage ordered by most to least prevalent	c267424e7d2bb5b10adff4d776fa14b0967bf0cc

<https://haveibeenpwned.com>

CHECK FOR BREACHED PASSWORDS!

Finding Pwned Passwords with 1Password

February 22, 2018 / 68 Comments / in News, Security, Watchtower / by Shiner

Yesterday, Troy Hunt launched [Pwned Passwords](#), a new service that allows you to check if your passwords have been leaked on the Internet. His database now has more than **500 million passwords** collected from various breaches. Checking your own passwords against this list is immensely valuable.

We loved Troy's new service so much that we couldn't help but create a proof of concept that integrates it with 1Password. Here's how it looks:



<https://blog.agilebits.com/2018/02/22/finding-pwned-passwords-with-1password/>

THE THREE R'S



Justin Smith

Follow

Identity and Security Geek

Apr 19 · 7 min read

The Three R's of Enterprise Security: Rotate, Repave, and Repair

<https://medium.com/built-to-adapt/the-three-r-s-of-enterprise-security-rotate-repave-and-repair-f64f6d6ba29d>

THE ADVANCED PERSISTENT THREAT

“At or near the top of security concerns in the datacenter is something called an Advanced Persistent Threat (APT). An APT gains unauthorized access to a network and can stay hidden for a long period of time. Its goal is usually to steal, corrupt, or ransom data.”

- Justin Smith, Pivotal



TARGET

N nieuwsuur

Dutch intelligence first to alert U.S. about Russian hack of Democratic Party

© DO 25 JANUARI, 21:35 AANGEPAST DO 25 JANUARI, 21:44 BUITENLAND

In the Summer of 2015, Dutch intelligence services were the first to alert their American counterparts about the cyberintrusion of the Democratic National Committee by Cozy Bear, a hacking group believed to be tied to the Russian government. Intelligence hackers from Dutch AIVD (General Intelligence and Security Service) had penetrated the Cozy Bear computer servers as well as a security camera at the entrance of their working space, located in a university building adjacent to the Red Square in Moscow.

Over the course of a few months, they saw how the Russians penetrated several U.S. institutions, including the State Department, the White House, and the DNC. On all these occasions, the Dutch alerted the U.S. intelligence services, Dutch tv programme *Nieuwsuur* and *de Volkskrant*, a prominent newspaper in The Netherlands, jointly report on Thursday. This account is based on interviews with a dozen political, diplomatic and intelligence sources in The Netherlands and the U.S. with direct knowledge of the matter. None of them wanted to speak on the record, given the classified details of the matter.

<https://nos.nl/nieuwsuur/artikel/2213767-dutch-intelligence-first-to-alert-u-s-about-russian-hack-of-democratic-party.html>

Rotate: Short-lived Credentials

Rotate: Short-lived Credentials

Repair: Patch Your Stuff

Rotate: Short-lived Credentials

Repair: Patch Your Stuff

Repave: Burn It Down!

Rotate: Short-lived Credentials

Repair: Patch Your Stuff

Repave: Burn It Down!

CODESPACES R.I.P.

Data Center ▶ **Cloud**

Code Spaces goes titsup FOREVER after attacker NUKES its Amazon-hosted data

Source-sharing site to close following total cloudpocalypse

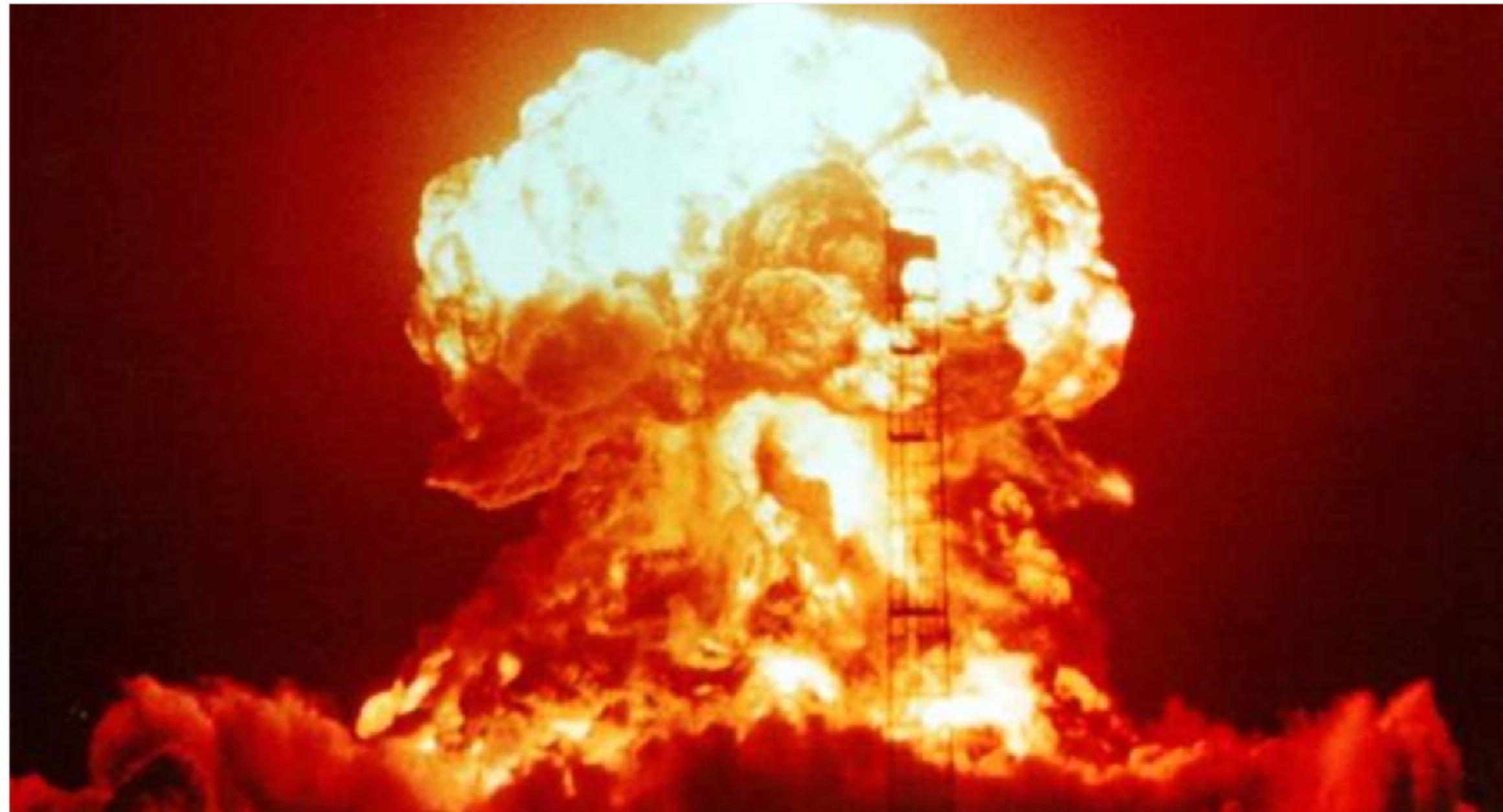

18 Jun 2014 at 20:54, Neil McAllister



547

http://www.theregister.co.uk/2014/06/18/code_spaces_destroyed/

CHECK FOR LEAKED CREDENTIALS

README.md

Gitrob: Putting the Open Source in OSINT

Gitrob is a command line tool which can help organizations and security professionals find sensitive information lingering in publicly available files on GitHub. The tool will iterate over all public organization and member repositories and match filenames against a range of patterns for files that typically contain sensitive or dangerous information.

Looking for sensitive information in GitHub repositories is not a new thing, it has been [known for a while](#) that things such as private keys and credentials can be found with GitHub's search functionality, however Gitrob makes it easier to focus the effort on a specific organization.

<https://github.com/michenriksen/gitrob>

Revocation & Rotation Of Credentials
+
Microservices
=
Pain???

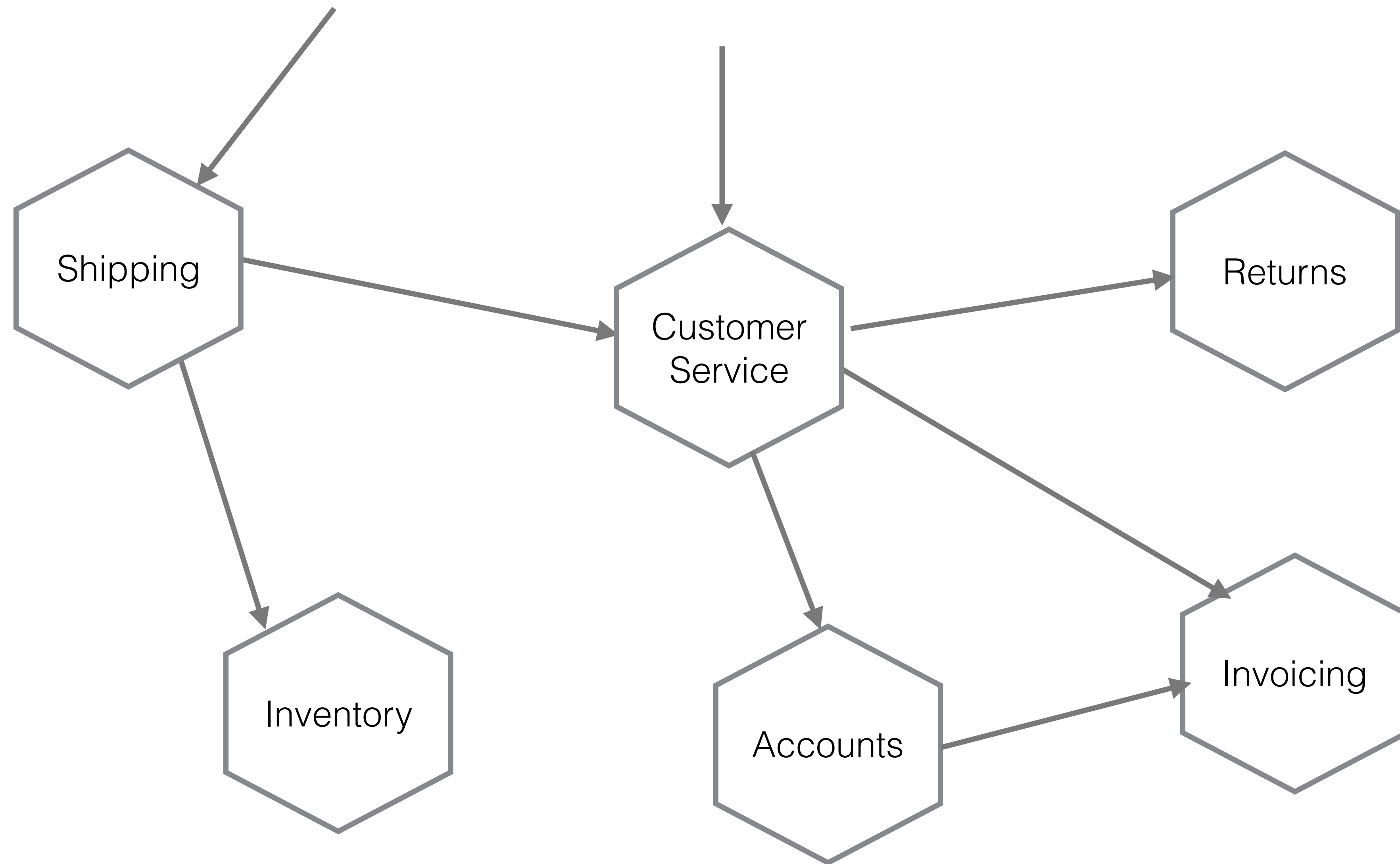

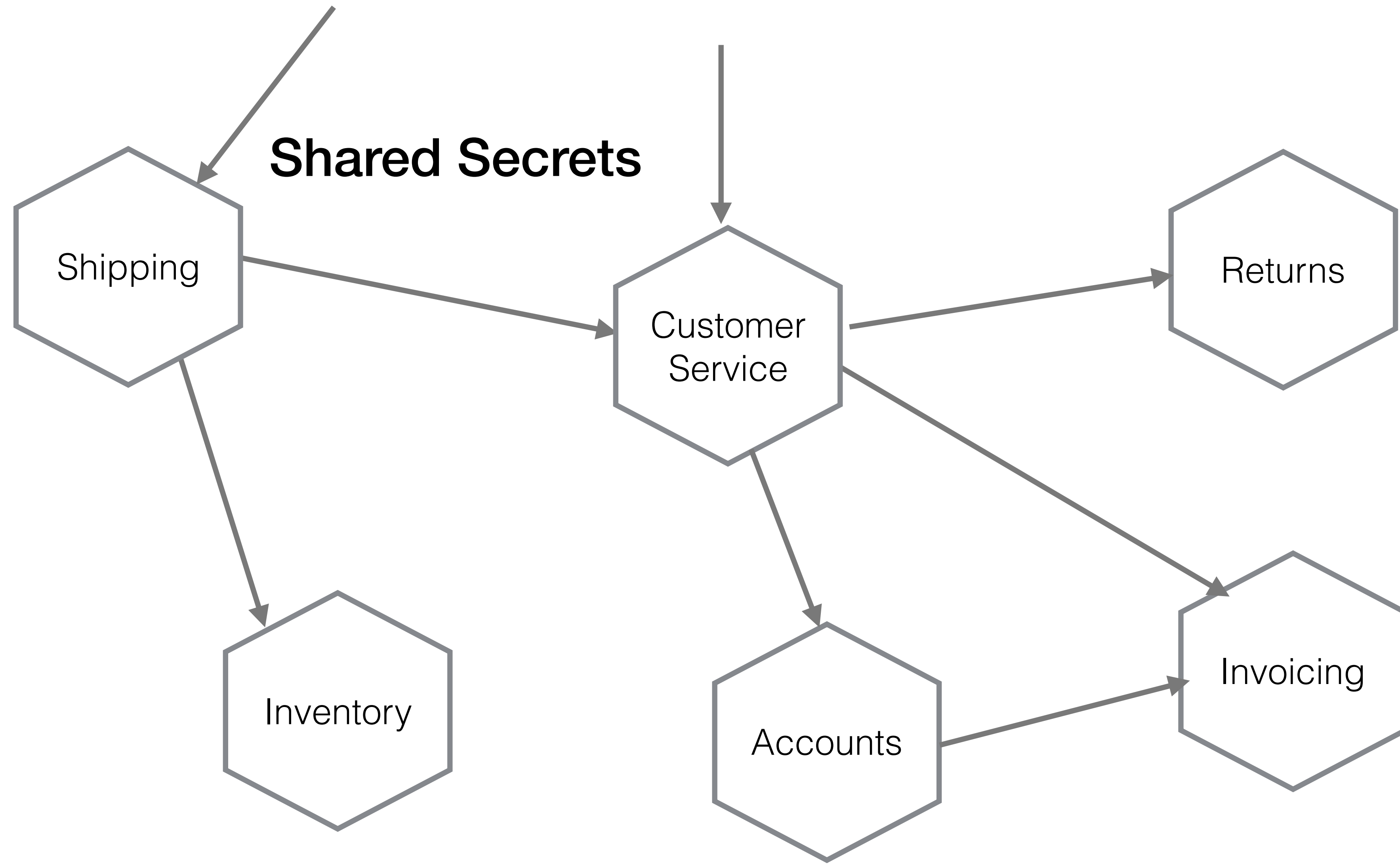

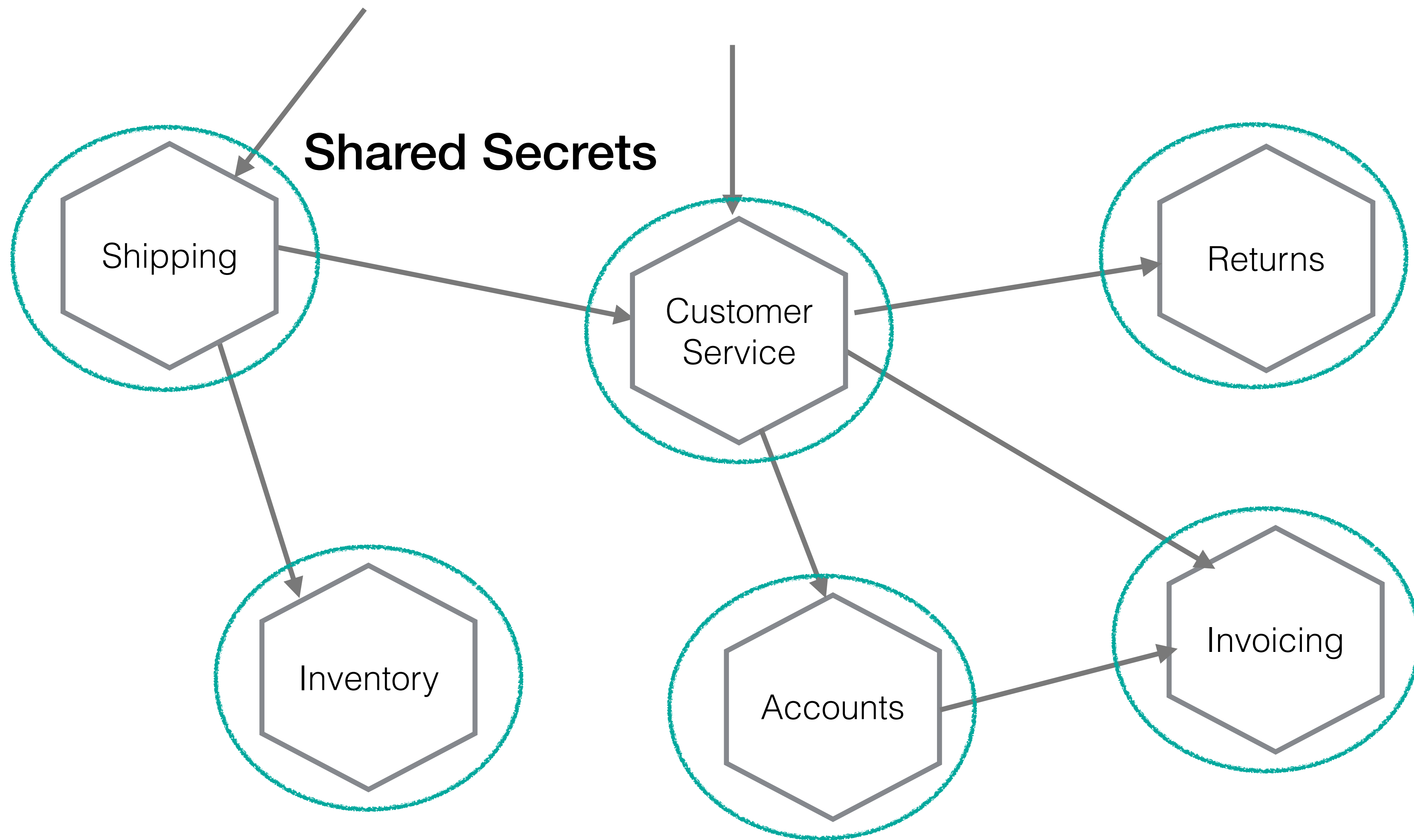

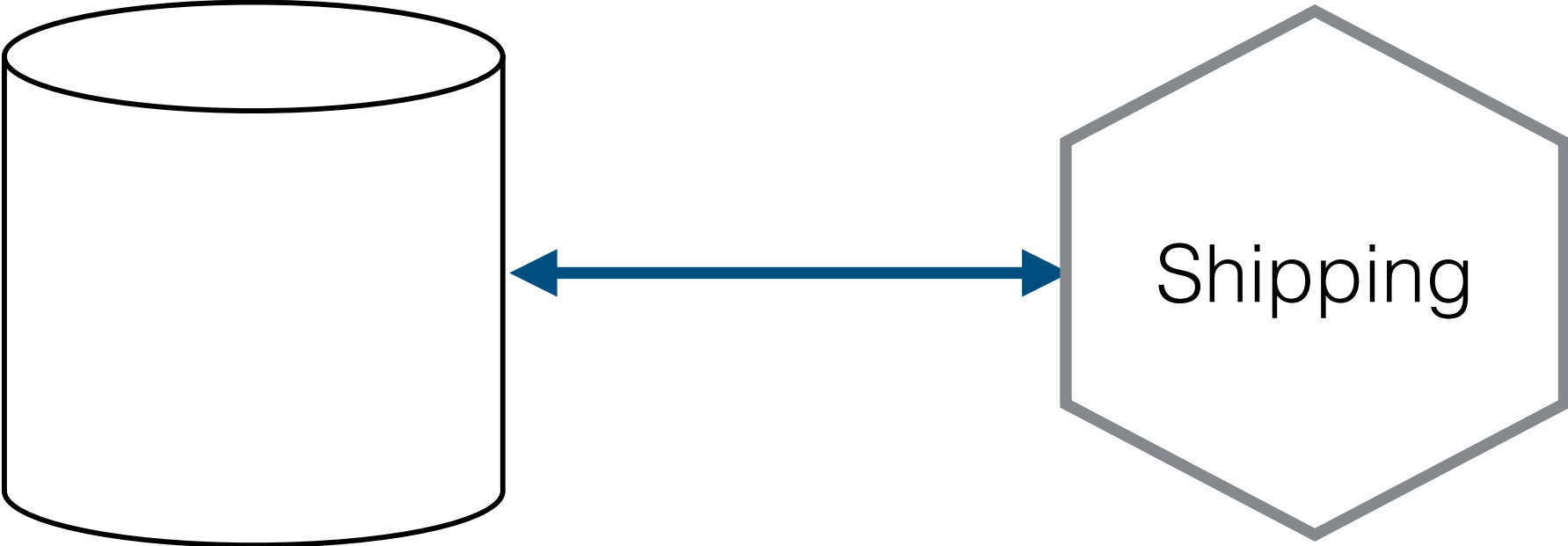

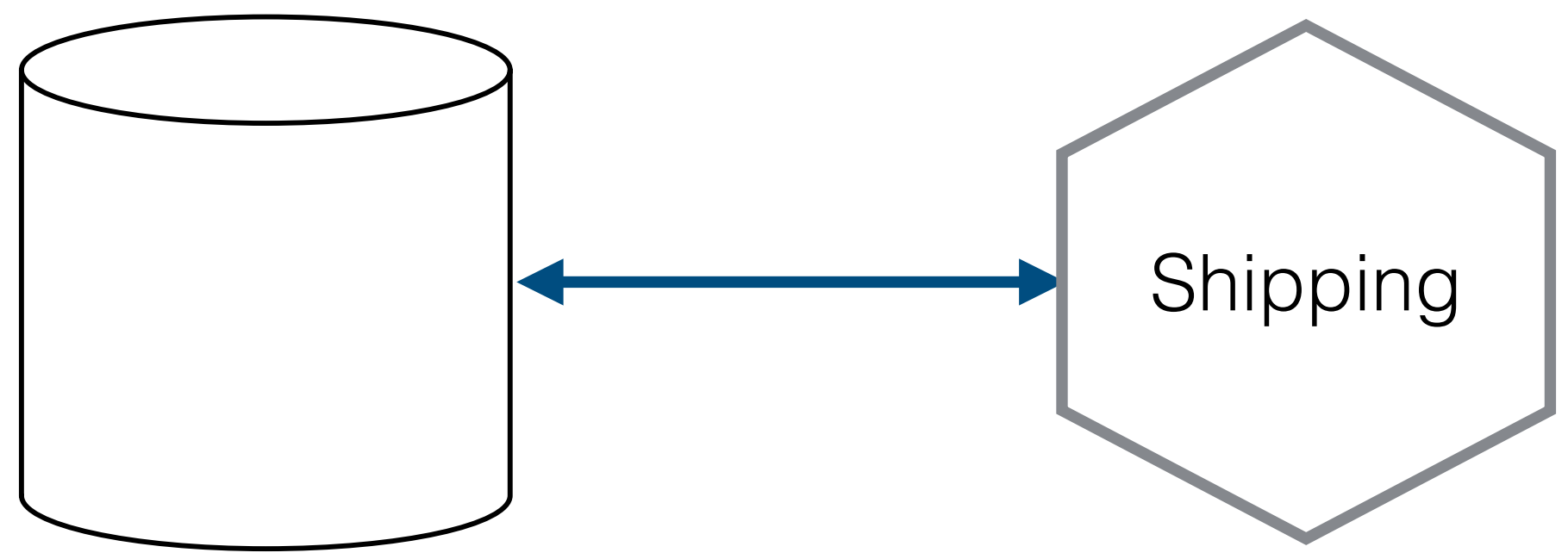

Auth Credentials

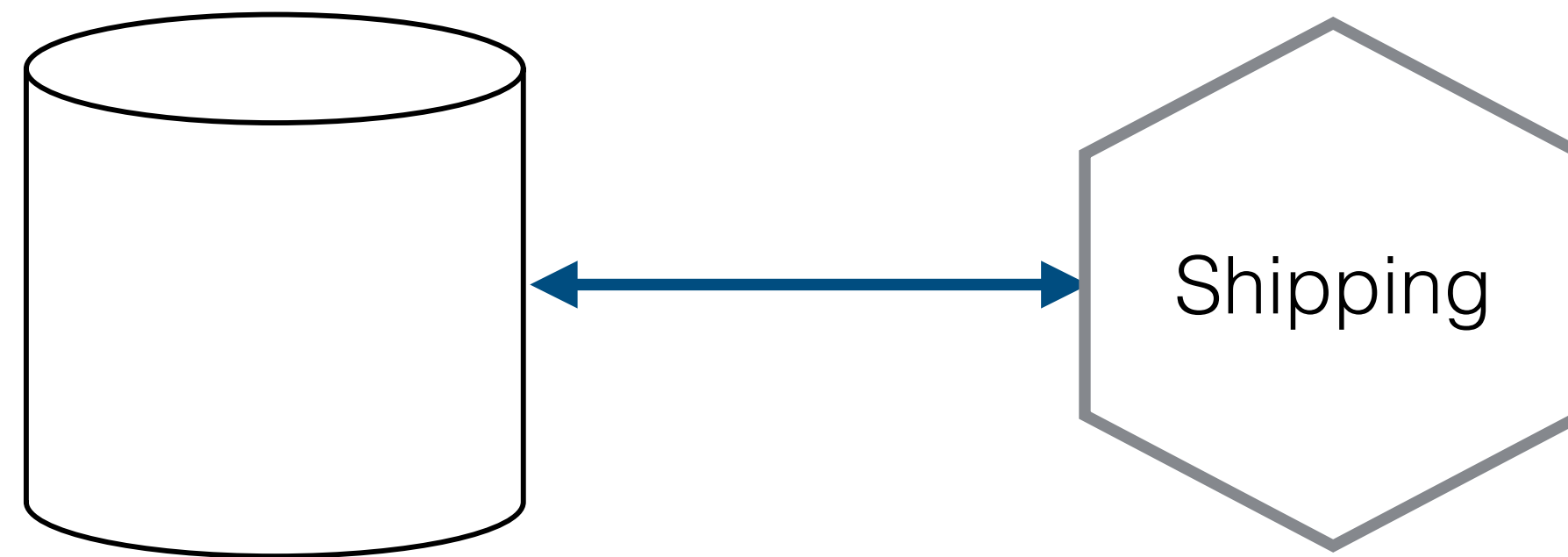

Auth Credentials

```
DB_USERNAME = admin  
DB_PASSWORD = 123ask48321
```

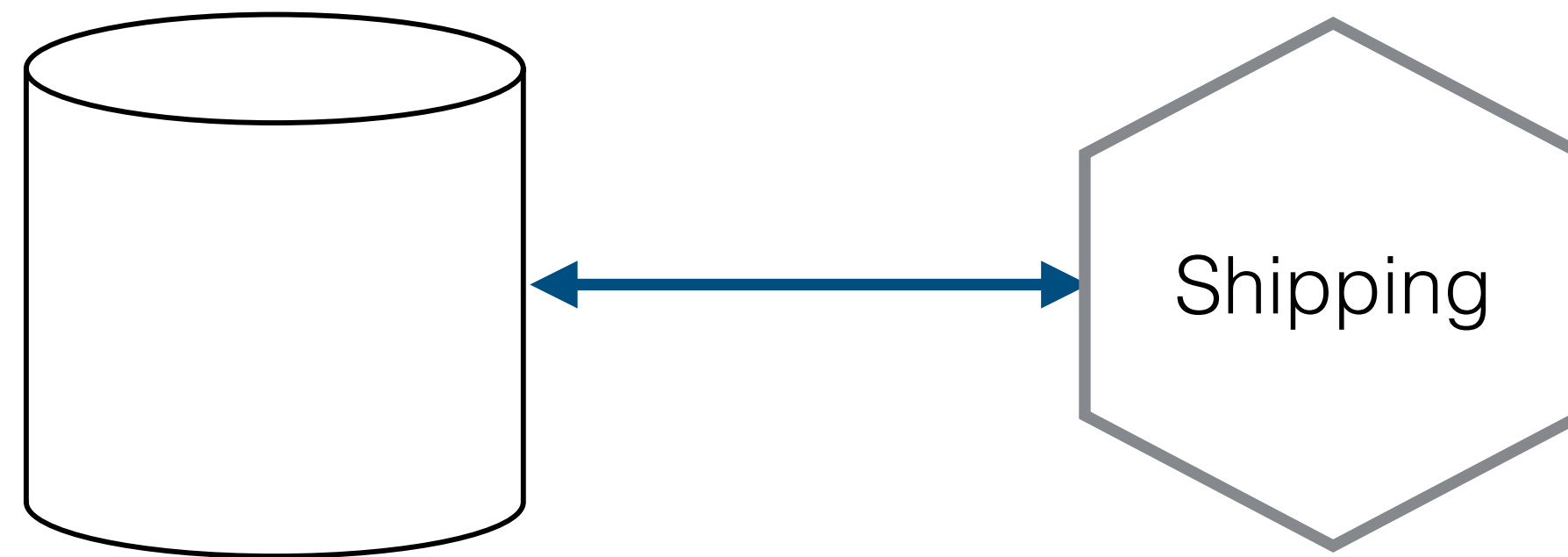

Auth Credentials

```
DB_USERNAME = admin  
DB_PASSWORD = 123ask48321
```

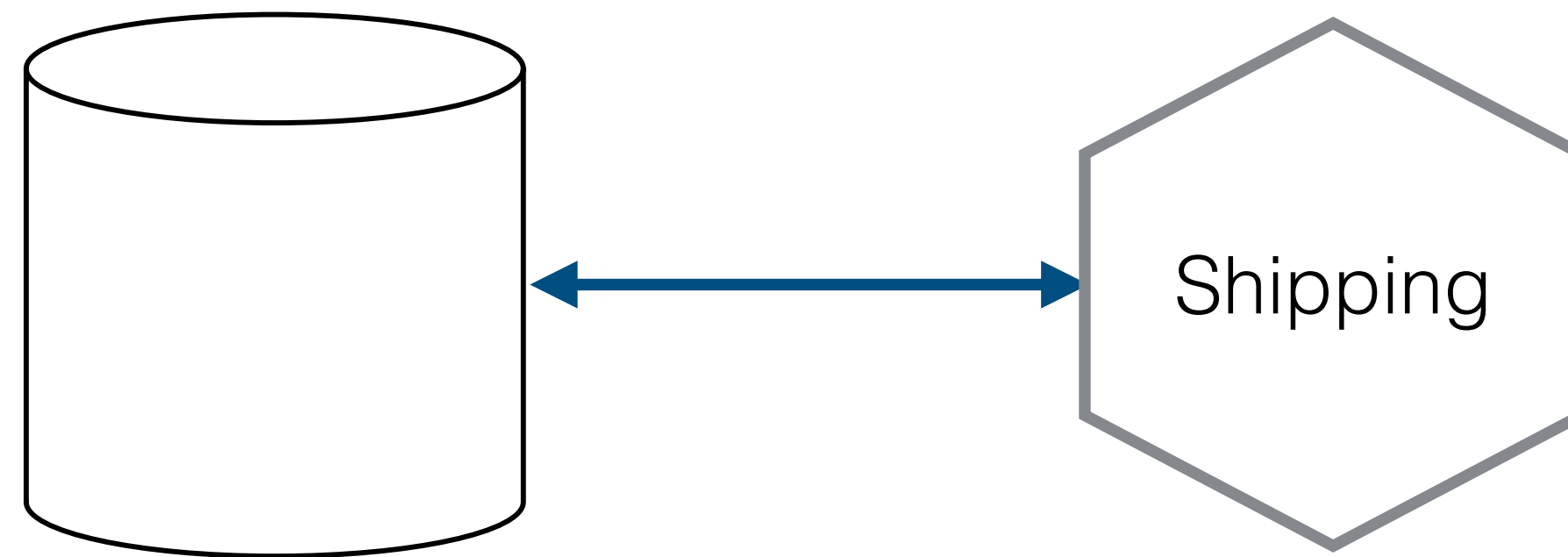
Auth Credentials

```
DB_USERNAME = admin  
DB_PASSWORD = 123ask48321
```

Leaving credentials in the open can be bad...

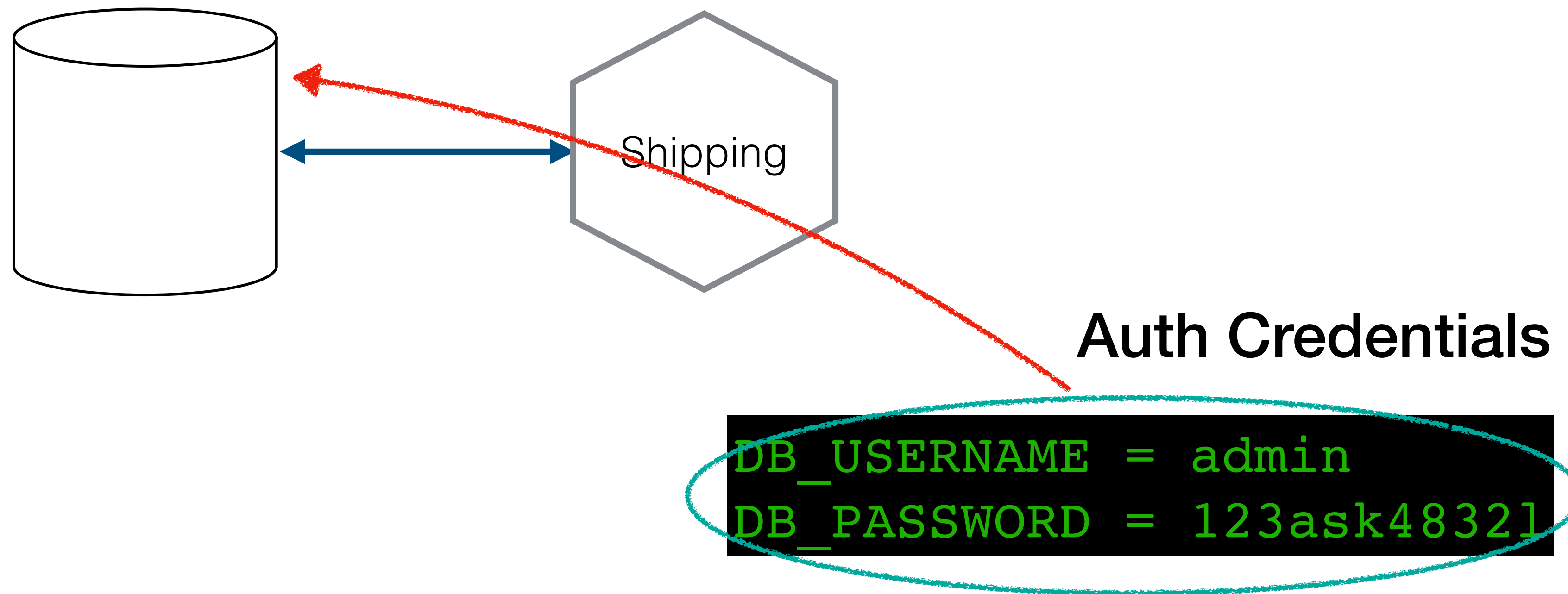

Leaving credentials in the open can be bad...

Secret stores!

VAULT

A tool for managing secrets.

[Get Started](#)



[Launch Interactive Tutorial](#)

```
...  
$ vault get api-key  
kk9290jf2mun9m09v20  
ivn20b2vg
```





A tool for managing secrets.

[Get Started](#)



[Launch Interactive Tutorial](#)

```
...  
$ vault get api-key  
kk9290jf2mun9m09v20  
ivn20b2vg
```



AWS Key Management Service
(KMS)

VAULT HIGH LEVEL OVERVIEW

Application

VAULT HIGH LEVEL OVERVIEW

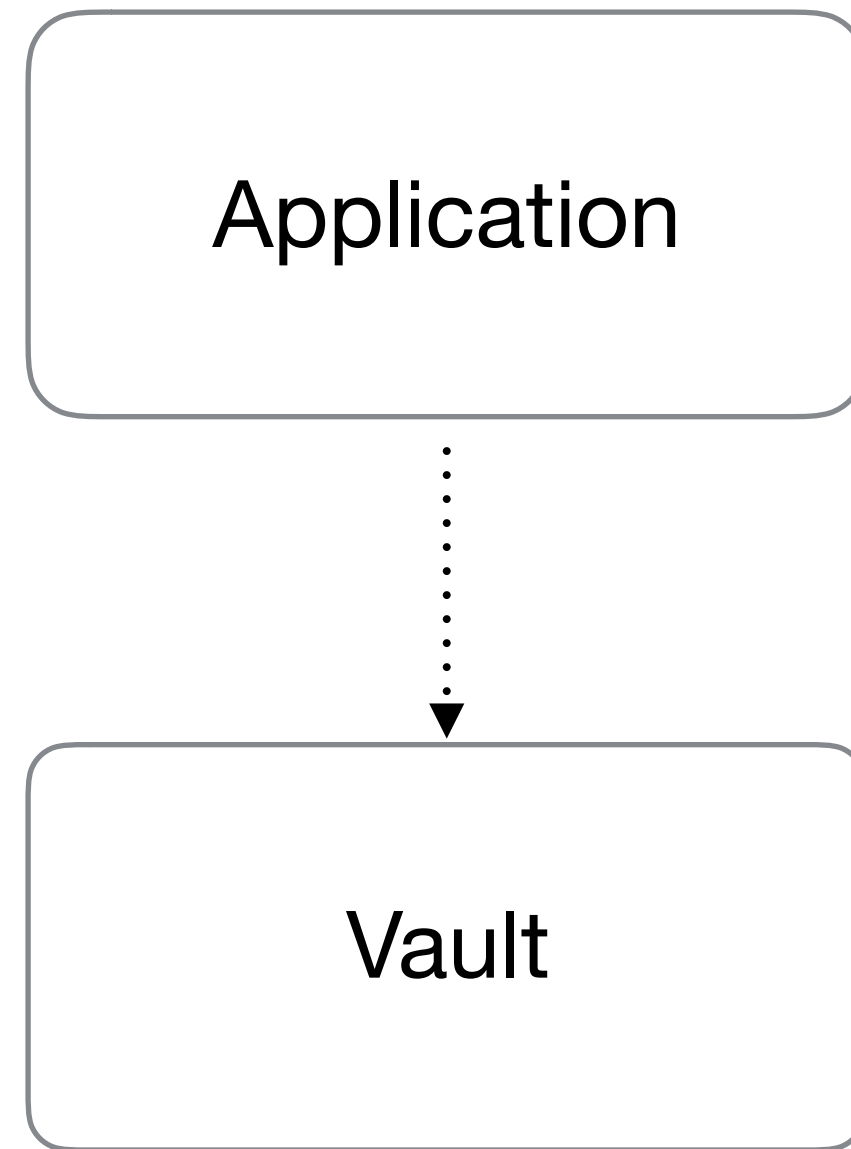

VAULT HIGH LEVEL OVERVIEW

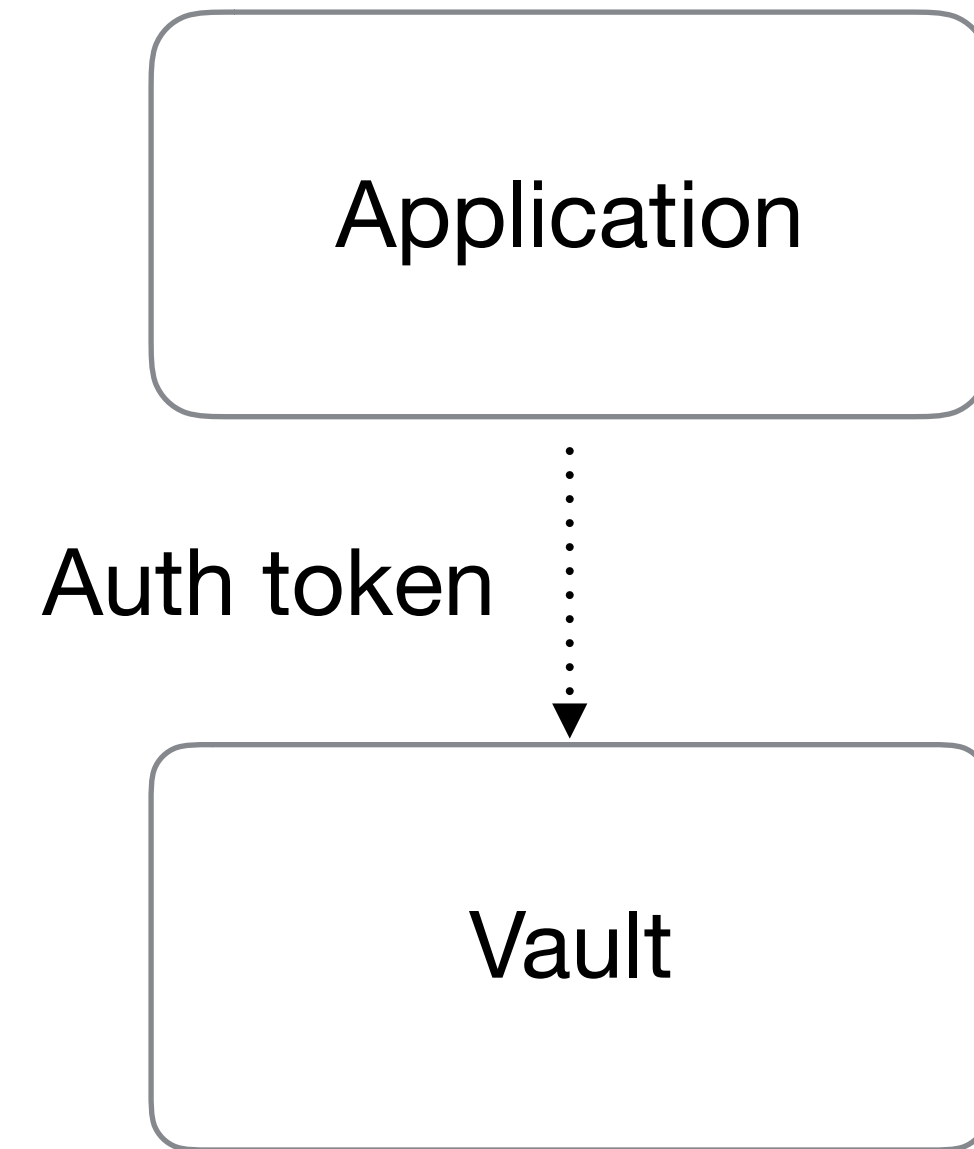

VAULT HIGH LEVEL OVERVIEW

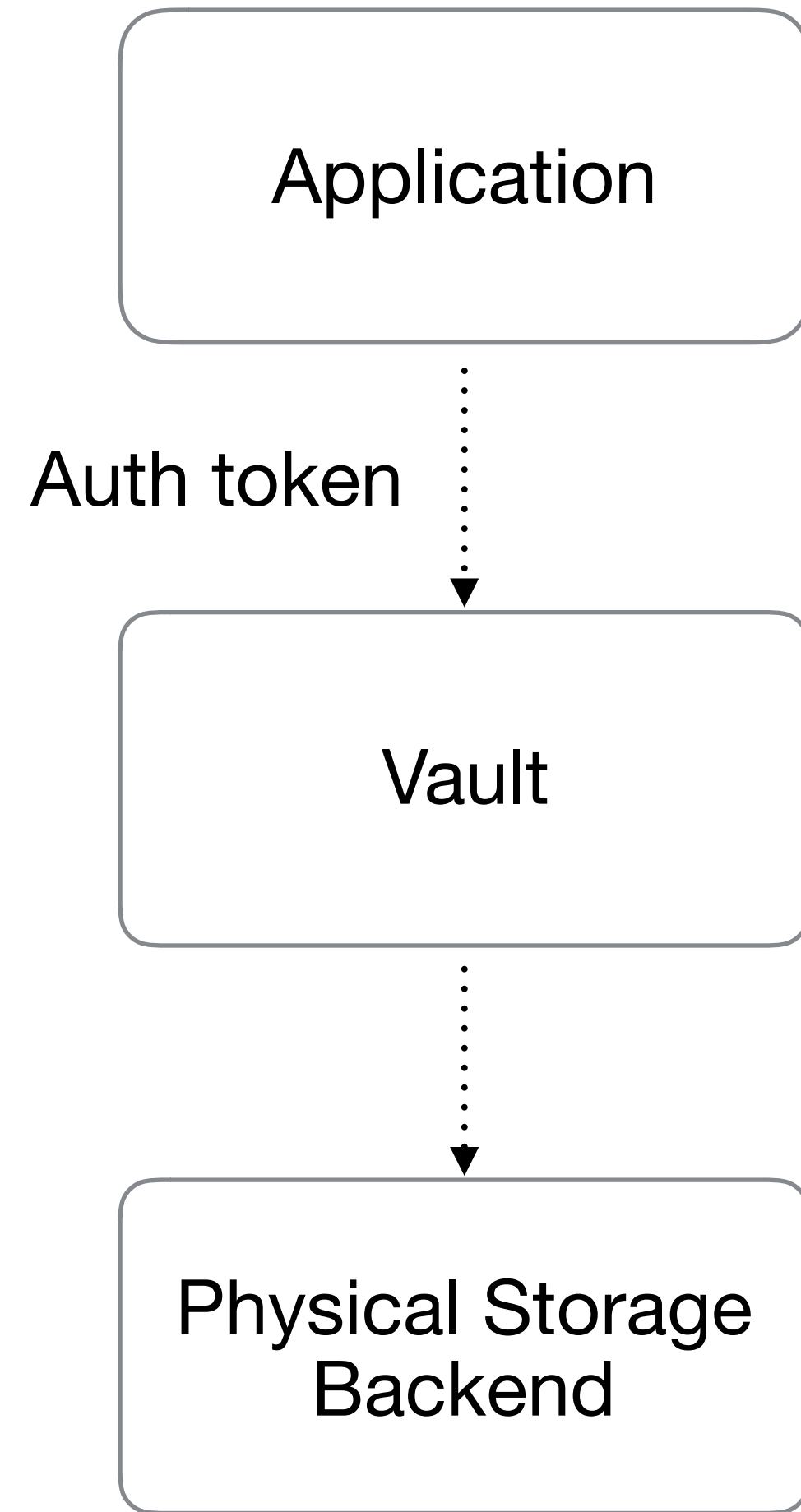

VAULT HIGH LEVEL OVERVIEW

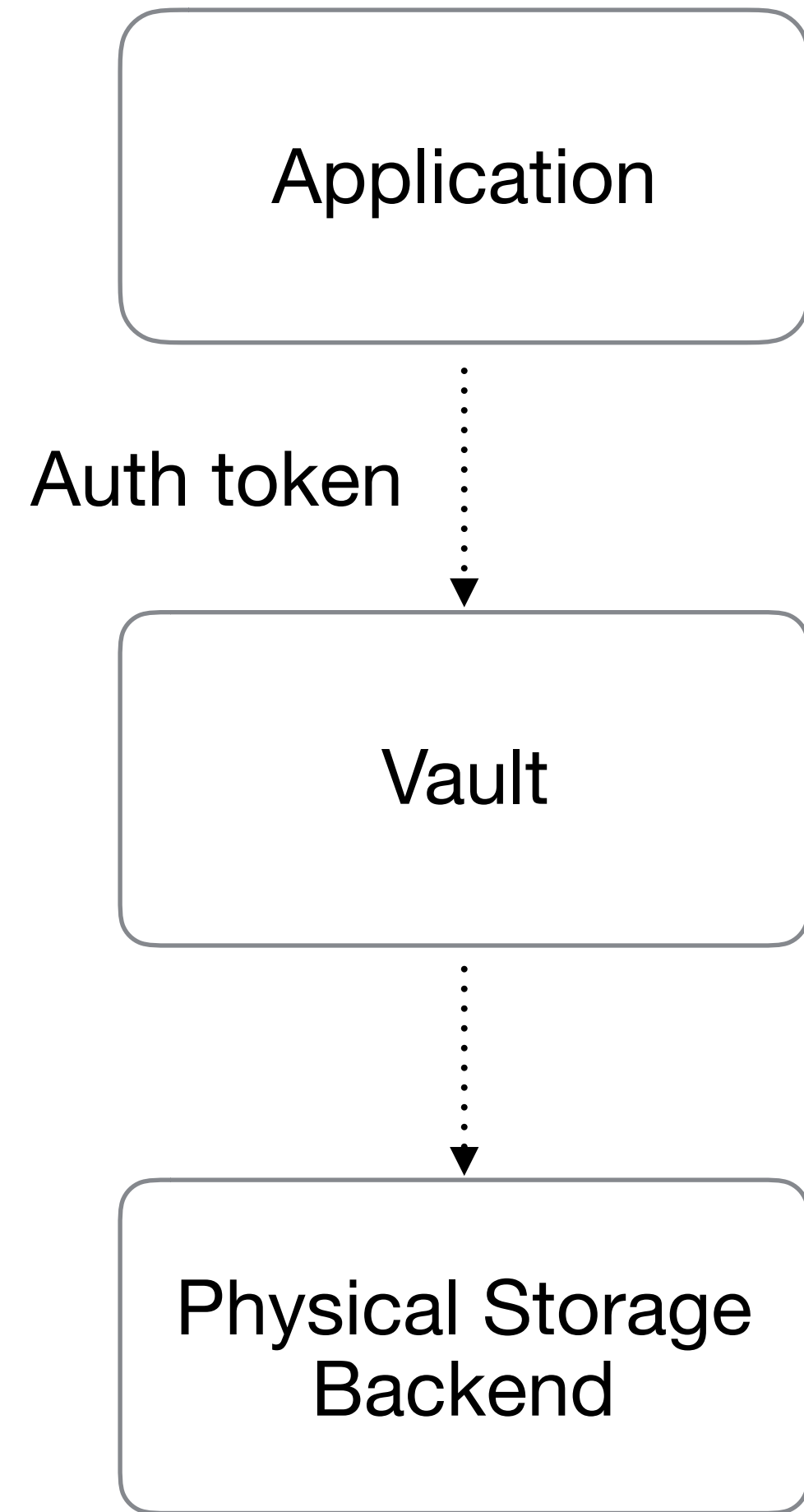

VAULT HIGH LEVEL OVERVIEW

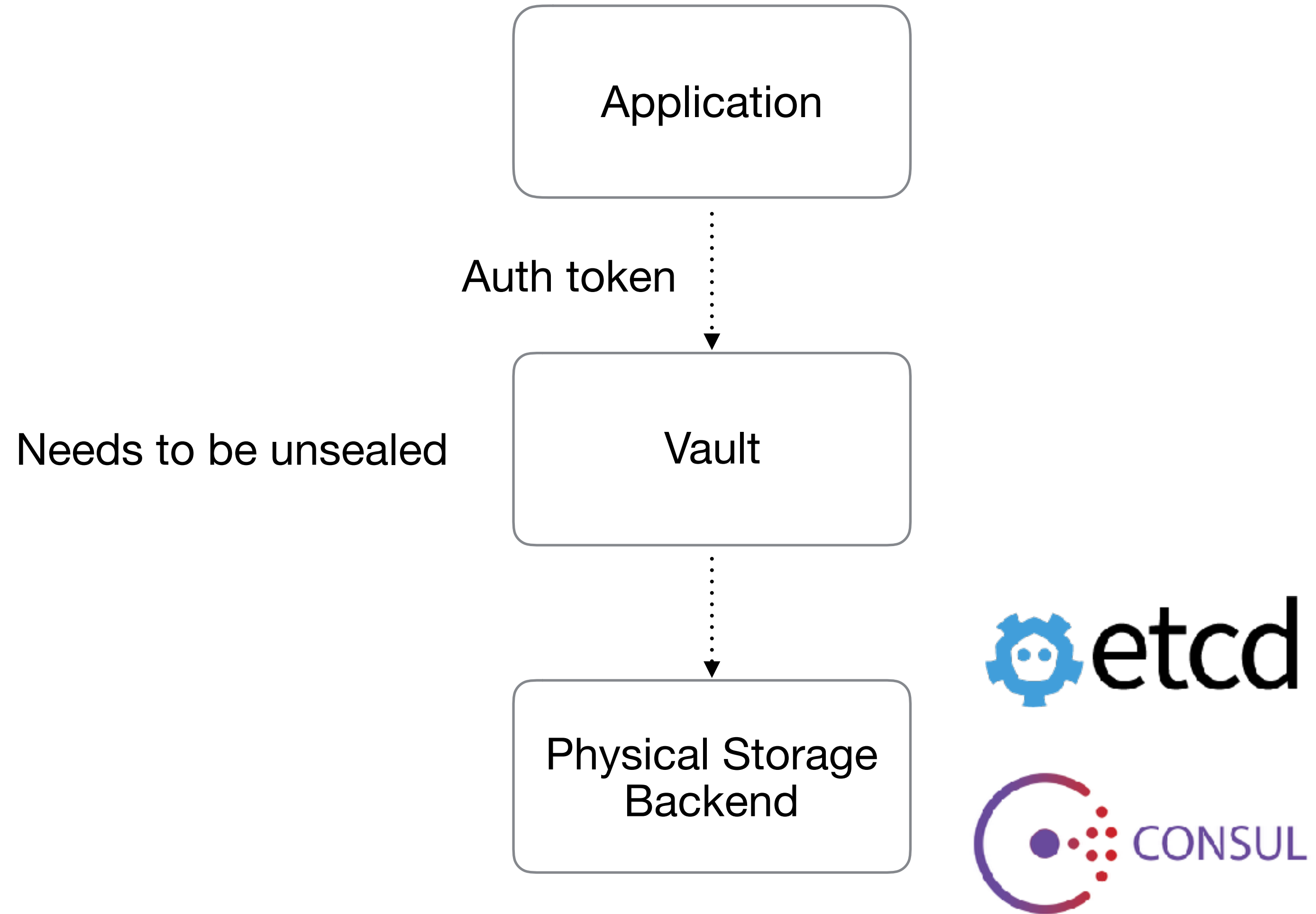

WHO HAS THE KEY?



<https://www.flickr.com/photos/quinnanya/2585541255/>

DON'T HAVE ONE KEY!

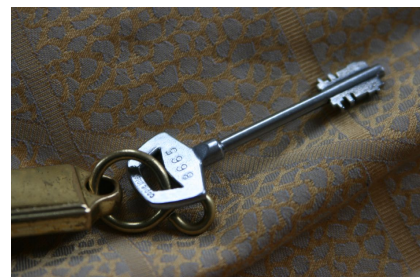
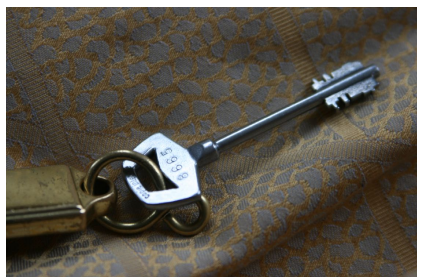
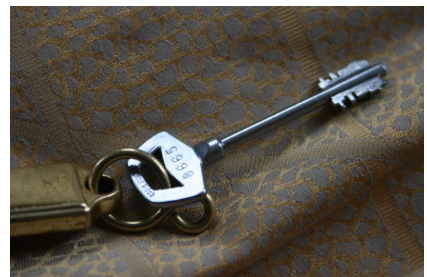
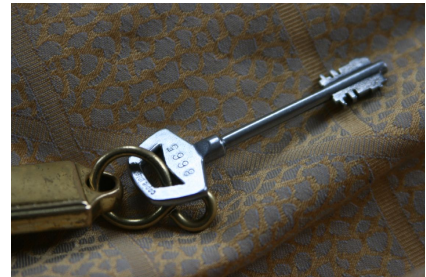

Vault

<https://www.flickr.com/photos/quinnanya/2585541255/>

DON'T HAVE ONE KEY!

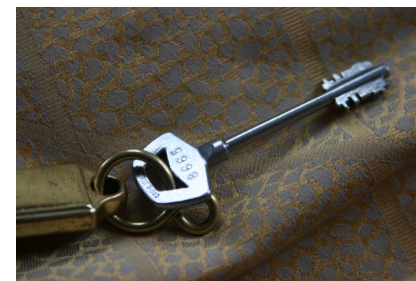
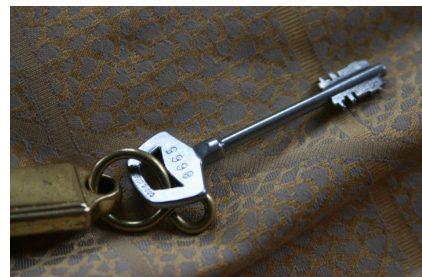
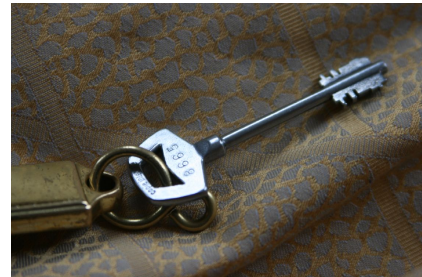

Vault

Shamir's Secret Sharing

From Wikipedia, the free encyclopedia



This article **may be too technical for most readers to understand**. Please [help improve it](#) to make it understandable to non-experts, without removing the technical details. *(March 2014)* ([Learn how and when to remove this template message](#))

Shamir's Secret Sharing is an [algorithm](#) in [cryptography](#) created by [Adi Shamir](#). It is a form of [secret sharing](#), where a secret is divided into parts, giving each participant its own unique part, where some of the parts or all of them are needed in order to reconstruct the secret.

Counting on all participants to combine the secret might be impractical, and therefore sometimes the *threshold scheme* is used where any k of the parts are sufficient to reconstruct the original secret.

https://en.wikipedia.org/wiki/Shamir%27s_Secret_Sharing

<https://www.flickr.com/photos/quinnanya/2585541255/>

DON'T HAVE ONE KEY!

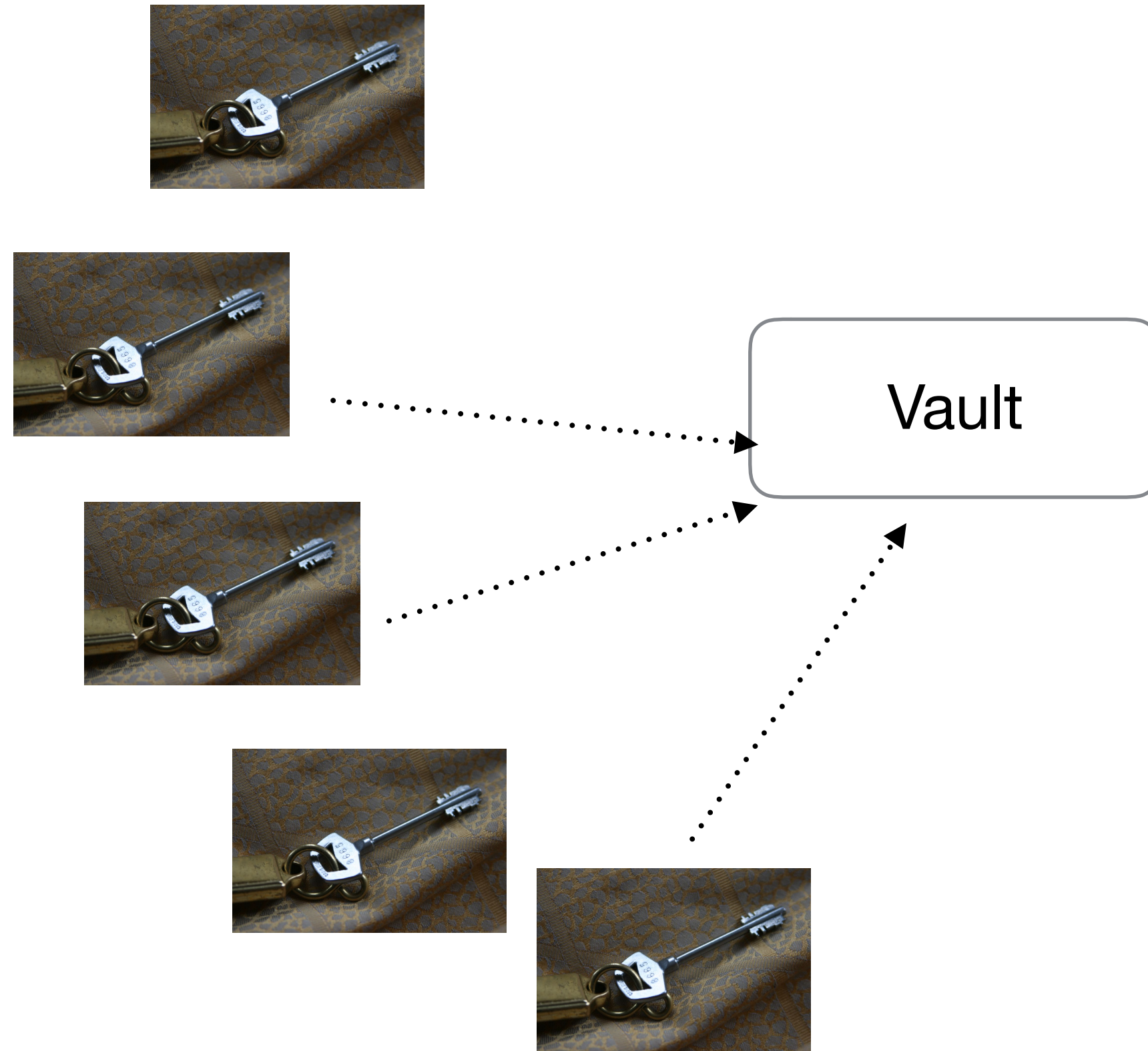

Shamir's Secret Sharing

From Wikipedia, the free encyclopedia



This article **may be too technical for most readers to understand**. Please [help improve it](#) to make it understandable to non-experts, without removing the technical details. *(March 2014)* ([Learn how and when to remove this template message](#))

Shamir's Secret Sharing is an [algorithm](#) in [cryptography](#) created by [Adi Shamir](#). It is a form of [secret sharing](#), where a secret is divided into parts, giving each participant its own unique part, where some of the parts or all of them are needed in order to reconstruct the secret.

Counting on all participants to combine the secret might be impractical, and therefore sometimes the *threshold scheme* is used where any k of the parts are sufficient to reconstruct the original secret.

https://en.wikipedia.org/wiki/Shamir%27s_Secret_Sharing

<https://www.flickr.com/photos/quinnanya/2585541255/>

TIME-LIMITED CREDENTIALS

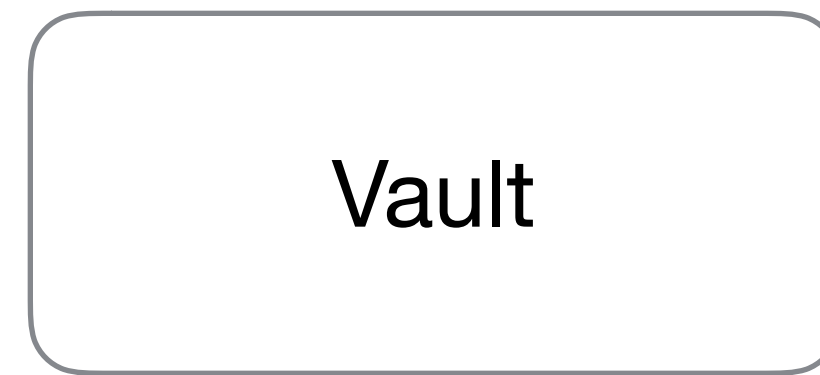

TIME-LIMITED CREDENTIALS

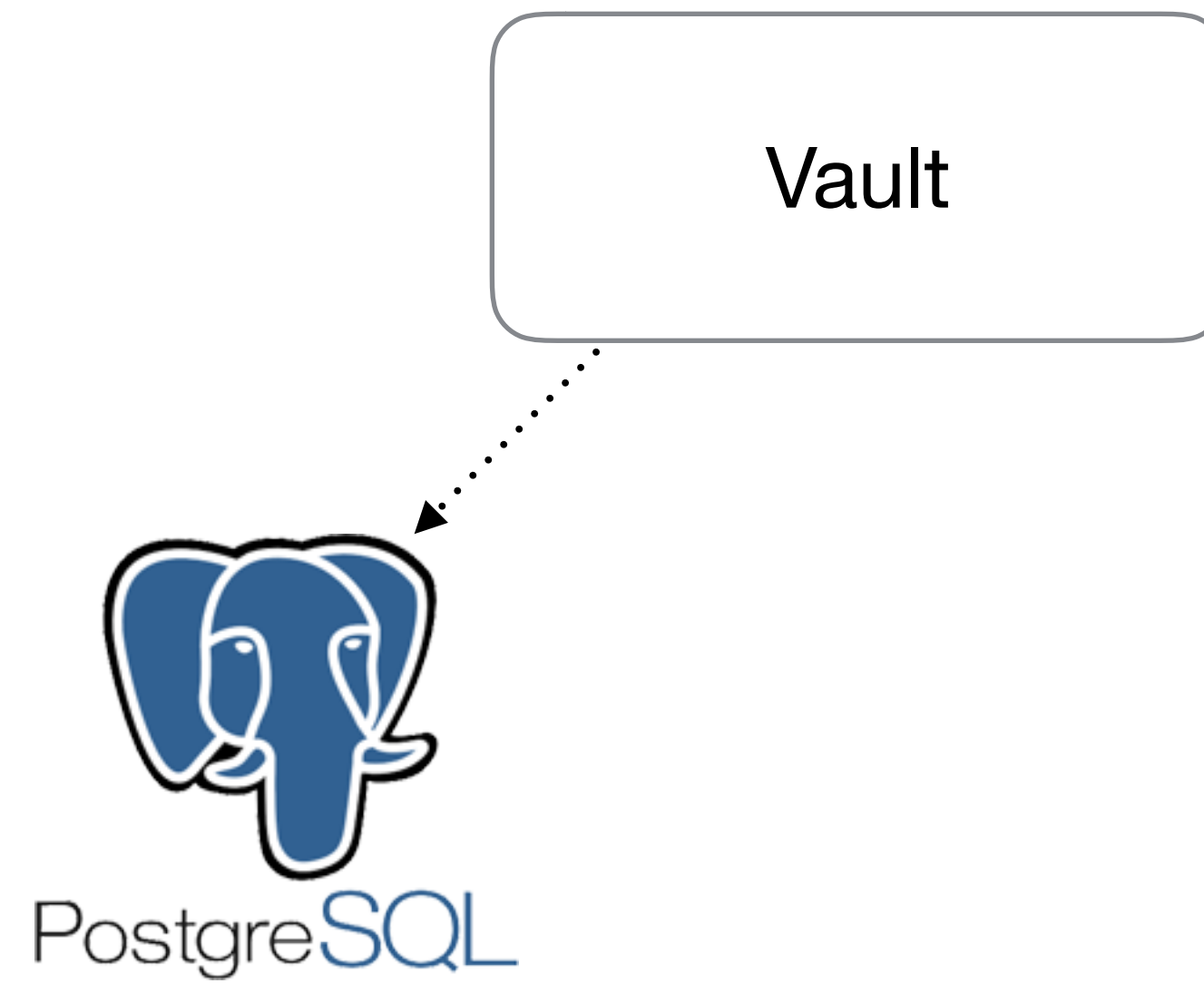

TIME-LIMITED CREDENTIALS

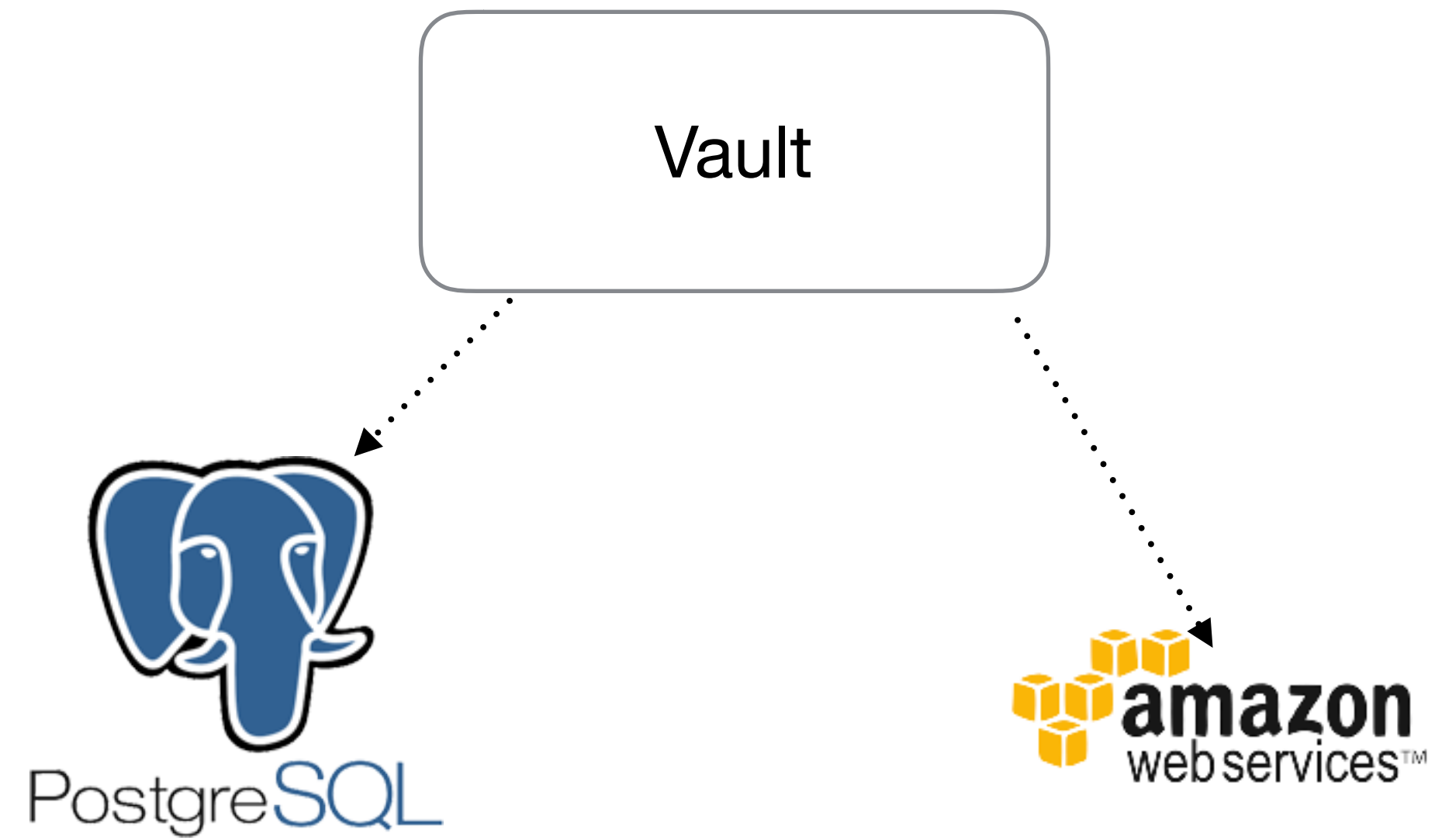

TIME-LIMITED CREDENTIALS

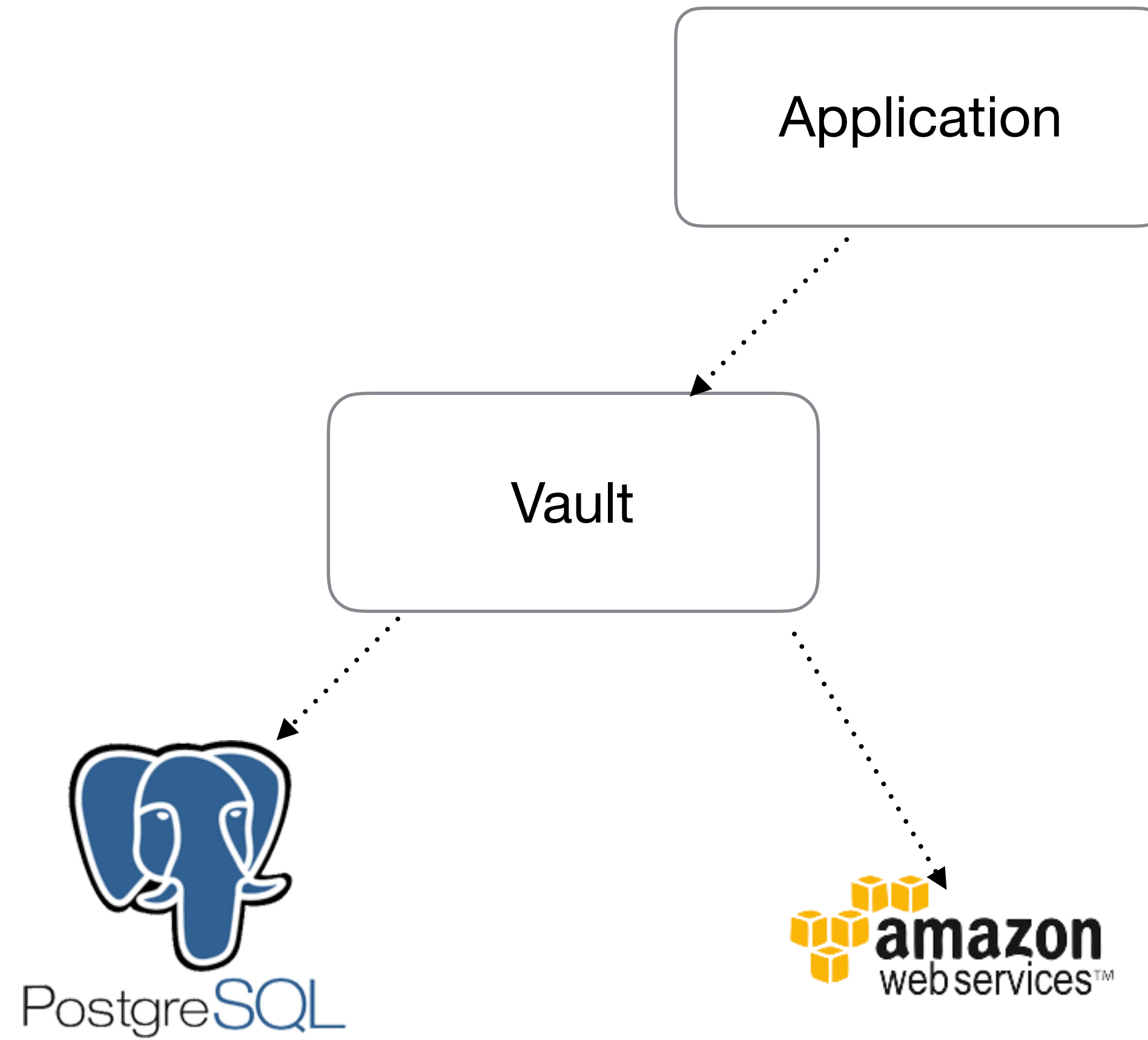

TIME-LIMITED CREDENTIALS

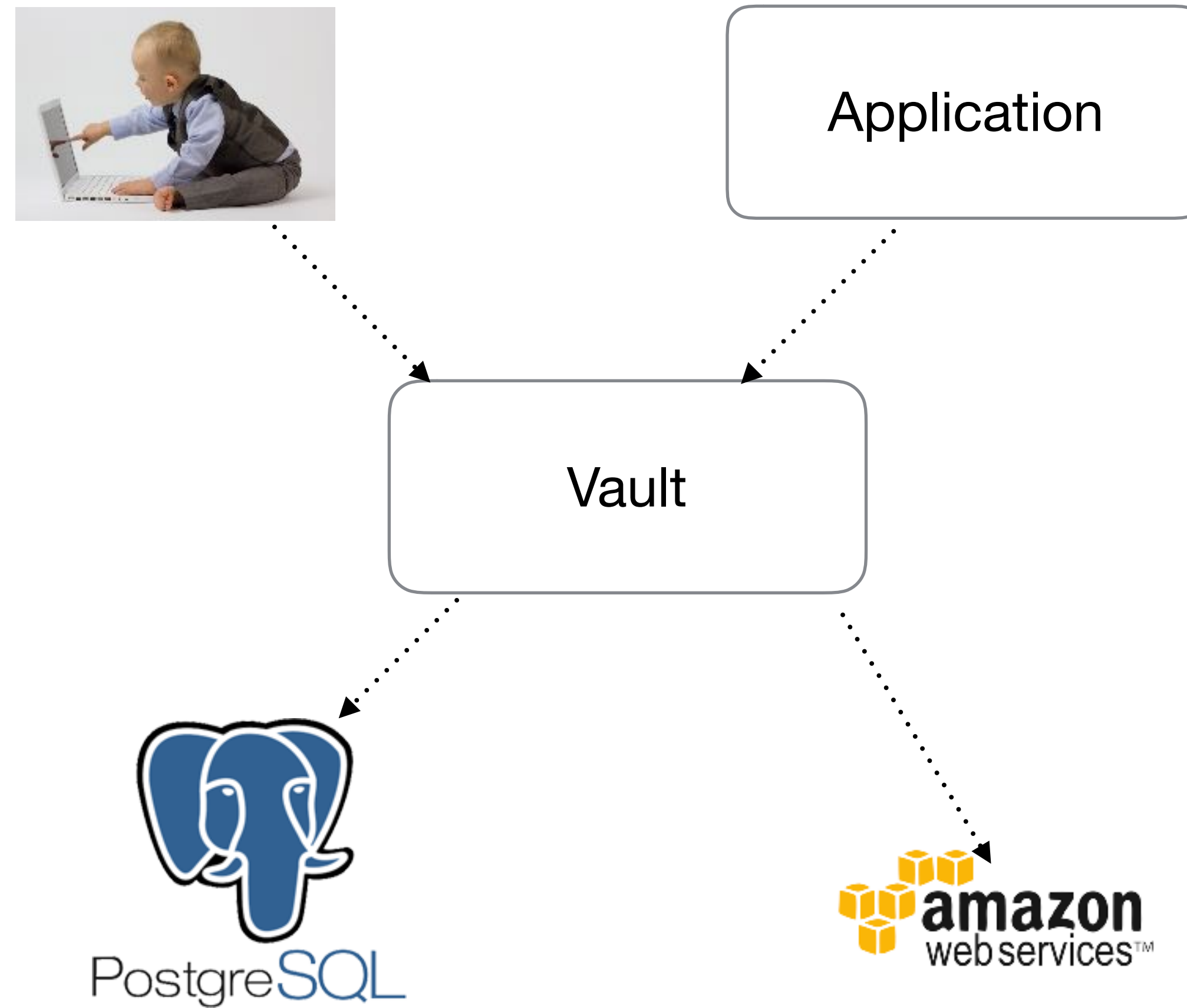

AWESOMENESS

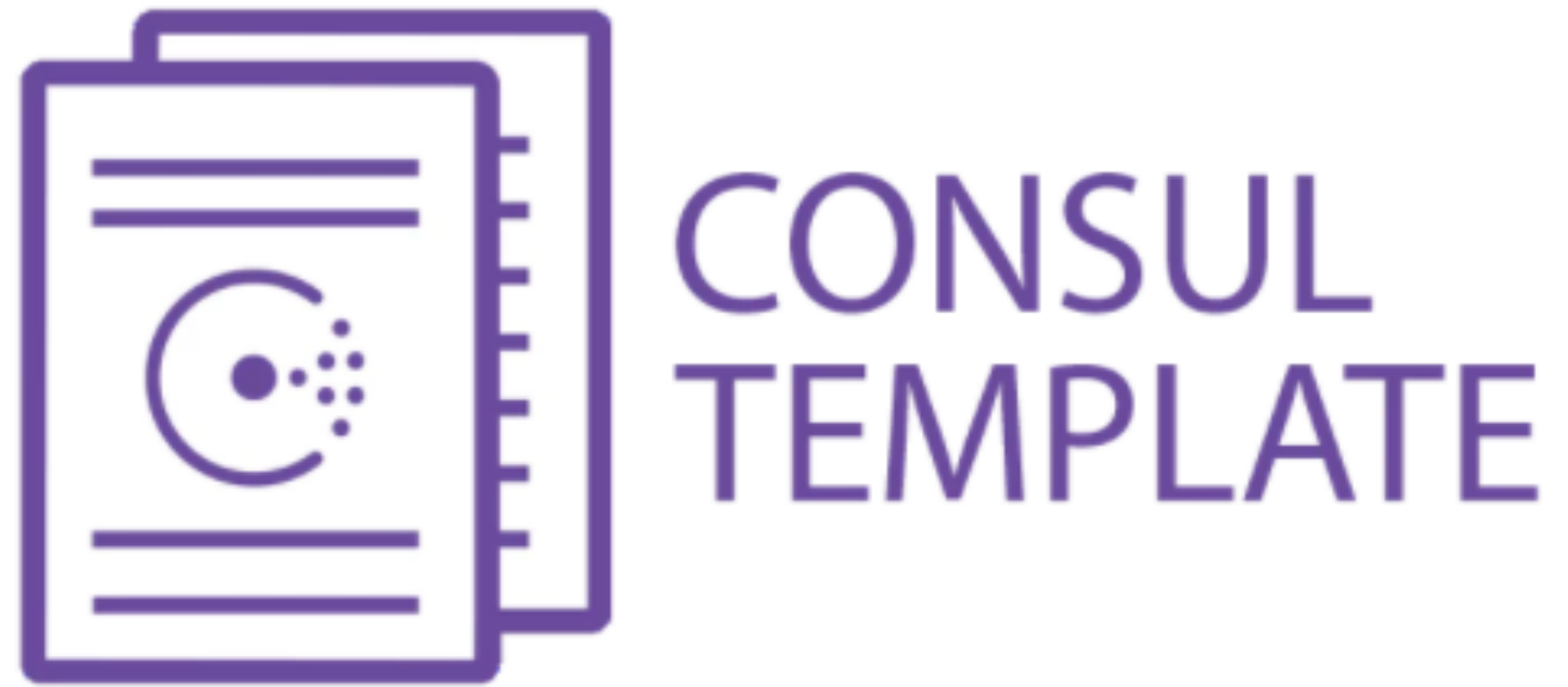

<https://github.com/hashicorp/consul-template>

AWESOMENESS



```
adapter: postgresql
host: {{key "my-app/production/host"}}
username: {{$secret.Data.username}}
password: {{$secret.Data.password}}
{{end}}
```

<https://github.com/hashicorp/consul-template>

From: <https://www.hashicorp.com/blog/using-vault-with-consul-template>

AWESOMENESS



<https://github.com/hashicorp/consul-template>

```
adapter: postgresql
host: {{key "my-app/production/host"}}
username: {{$secret.Data.username}}
password: {{$secret.Data.password}}
{{end}}
```

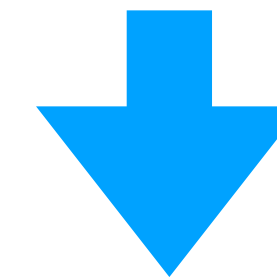

From: <https://www.hashicorp.com/blog/using-vault-with-consul-template>

AWESOMENESS



CONSUL
TEMPLATE

<https://github.com/hashicorp/consul-template>

```
adapter: postgresql
host: {{key "my-app/production/host"}}
username: {{$secret.Data.username}}
password: {{$secret.Data.password}}
{{end}}
```

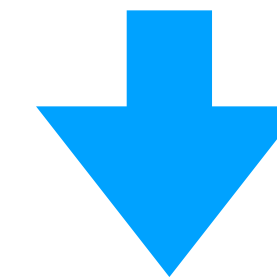

```
adapter: postgresql
host: db-service-183.corp.com
username: as15593kd235423
password: fk1k11492309482
{{end}}
```

From: <https://www.hashicorp.com/blog/using-vault-with-consul-template>

WHAT ELSE CAUSES BREACHES?

“44 percent of security breaches occur after vulnerabilities and solutions have been identified. In other words, the problems could have been avoided if found vulnerabilities had been addressed sooner.”

- Forbes/BMC, 2016

Massive Equifax data breach - what you need to know



By [Callum Mason](#), News Reporter
12 Sep 2017 | Updated 19 Sep 2017



Credit report heavyweight Equifax has warned that up to 400,000 UK consumers may have had their personal details stolen as part of a massive global data breach. Info on exactly who's been affected and what you can do about it is still somewhat sketchy, but here's what we know.

Equifax revealed on 8 September that 143 million consumers in the US could have been affected by the incident, which saw hackers access data such as names, address and dates of birth, as well as credit card numbers in a smaller number of cases.

Although its UK business – Equifax Ltd – now says systems in this country are not affected, it admits a file which was stored in the US and contained more limited personal information on up to 400,000 UK consumers may have been accessed.

Related MSE Guides

[Credit Scores](#)

Bust myths & improve your score

[30+ Ways to Stop Scams](#)

As scams get clever, we need to too!

[Check your credit report for free](#)

Grab your file and check your score, or even get PAID to do it



Get Our Free Money Tips Email!

For all the latest deals, guides and loopholes - join the 12m who get it.

Don't miss out

GET IT!

[FAQs](#) | [Privacy Policy](#) | [Past Emails](#) | [Unsubscribe](#)

What is Equifax and what data does it have?

Equifax is the second biggest credit reference agency in the UK, after Experian.

<https://www.moneysavingexpert.com/news/protect/2017/09/massive-equifax-data-breach---what-you-need-to-know>

PATCH MUCH?

Equifax confirms march struts vulnerability behind breach

by Chris Brook for Threat Post **Equifax said the culprit** September 14, 2017, 4:00 pm
behind this summer's massive breach of 143 million Americans was indeed CVE-2017-5638, an Apache Struts vulnerability patched back in March.

The bug was widely assumed by experts to be the "U.S. website application vulnerability" implicated by the company last Thursday, especially after an Apache spokeswoman **told Reuters** on Friday that it appeared the consumer credit reporting agency hadn't applied patches for flaws discovered earlier this year.

On Wednesday company specified the flaw in a statement posted to its site and stressed it was continuing to work alongside law enforcement to investigate the incident.

<https://www.pinkconnect.com/equifax-confirms-march-struts-vulnerability-behind-breach/>

PATCH MUCH?

Equifax confirms march struts vulnerability behind breach

by Chris Brook for Threat Post Equifax said the culprit behind this summer's massive breach of 143 million Americans was indeed CVE-2017-5638, an Apache Struts vulnerability patched back in March.

September 14, 2017, 4:00 pm

The bug was widely assumed by experts to be the "U.S. website application vulnerability" implicated by the company last Thursday. Reuters on Friday that it appeared the company had patches for flaws discovered earlier this month.

On Wednesday company specified the firm was continuing to work alongside law enforcement.

"Equifax has been intensely investigating the scope of the intrusion with the assistance of a leading, independent cybersecurity firm to determine what information was accessed and who has been impacted. We know that criminals exploited a U.S. website application vulnerability. The vulnerability was Apache Struts CVE-2017-5638. We continue to work with law enforcement as part of our criminal investigation, and have shared indicators of compromise with law enforcement."

<https://www.pinkconnect.com/equifax-confirms-march-struts-vulnerability-behind-breach/>

PATCH MUCH?

Equifax confirms march struts vulnerability behind breach

by Chris Brook for Threat Post Equifax said the culprit behind this summer's massive breach of 143 million Americans was indeed CVE-2017-5638, an Apache Struts vulnerability patched back in March.

The bug was widely assumed by experts to be the "U.S. website application vulnerability" implicated by the company last Thursday. Reuters on Friday that it appeared the company had patched for flaws discovered earlier this month.

On Wednesday company specified the firm was continuing to work alongside law enforcement.

CVE-2017-5638

"Equifax has been intensely investigating the scope of the intrusion with the assistance of a leading, independent cybersecurity firm to determine what information was accessed and who has been impacted. We know that criminals exploited a U.S. website application vulnerability. The vulnerability was Apache Struts CVE-2017-5638. We continue to work with law enforcement as part of our criminal investigation, and have shared indicators of compromise with law enforcement."

<https://www.pinkconnect.com/equifax-confirms-march-struts-vulnerability-behind-breach/>

CVE-2017-5638

Current Description

The Jakarta Multipart parser in Apache Struts 2 2.3.x before 2.3.32 and 2.5.x before 2.5.10.1 has incorrect exception handling and error-message generation during file-upload attempts, which allows remote attackers to execute arbitrary commands via a crafted Content-Type, Content-Disposition, or Content-Length HTTP header, as exploited in the wild in March 2017 with a Content-Type header containing a #cmd= string.

Source: MITRE Last Modified: 09/22/2017 [+View Analysis Description](#)

Impact

CVSS Severity (version 3.0):

CVSS v3 Base Score: 10.0 Critical

Vector: CVSS:3.0/AV:N/AC:L/PR:N/UI:N/S:C/C:H/I:H/A:H (legend)

Impact Score: 6.0

Exploitability Score: 3.9

CVE-2017-5638

Current Description

The Jakarta Multipart parser in Apache Struts 2 2.3.x before 2.3.32 and 2.5.x before 2.5.10.1 has incorrect exception handling and error-message generation during file-upload attempts, which allows remote attackers to execute arbitrary commands via a crafted Content-Type, Content-Disposition, or Content-Length HTTP header, as exploited in the wild in March 2017 with a Content-Type header containing a #cmd= string.

Source: MITRE Last Modified: 09/22/2017 [+View Analysis Description](#)

Impact

CVSS Severity (version 3.0):

CVSS v3 Base Score: 10.0 Critical

Vector: CVSS:3.0/AV:N/AC:L/PR:N/UI:N/S:C/C:H/I:H/A:H (legend)

Impact Score: 6.0

Exploitability Score: 3.9

Impact

CVSS Severity (version 3.0):

CVSS v3 Base Score: 10.0 Critical

CVE-2017-5638

Current Description

The Jakarta Multipart parser in Apache Struts 2 2.3.x before 2.3.32 and 2.5.x before 2.5.10.1 has incorrect exception handling and error-message generation during file-upload attempts, which allows remote attackers to execute arbitrary commands via a crafted Content-Type, Content-Disposition, or Content-Length HTTP header, as exploited in the wild in March 2017 with a Content-Type header containing a #cmd= string.

Source: MITRE Last Modified: 09/22/2017 [+View Analysis Description](#)

Impact

CVSS Severity (version 3.0):

CVSS v3 Base Score: 10.0 Critical

Vector: CVSS:3.0/AV:N/AC:L/PR:N/UI:N/S:C/C:H/I:H/A:H (legend)

Impact Score: 6.0

Exploitability Score: 3.9

Impact

CVSS Severity (version 3.0):

CVSS v3 Base Score: 10.0 Critical

CVE-2017-5638

Current Description

The Jakarta Multipart parser in Apache Struts 2 2.3.x before 2.3.32 and 2.5.x before 2.5.10.1 has incorrect exception handling and error-message generation during file-upload attempts, which allows remote attackers to execute arbitrary commands via a crafted Content-Type, Content-Disposition, or Content-Length HTTP header, as exploited in the wild in March 2017 with a Content-Type header containing a #cmd= string.

Source: MITRE Last Modified: 09/22/2017 [+View Analysis Description](#)

Impact

CVSS Severity (version 3.0):

CVSS v3 Base Score: 10.0 Critical

Vector: CVSS:3.0/AV:N/AC:L/PR:N/UI:N/S:C/C:H/I:H/A:H (legend)

Impact Score: 6.0

Exploitability Score: 3.9

Impact

CVSS Severity (version 3.0):

CVSS v3 Base Score: 10.0 Critical

Reported March 2017

CVE-2017-5638

Current Description

The Jakarta Multipart parser in Apache Struts 2 2.3.x before 2.3.32 and 2.5.x before 2.5.10.1 has incorrect exception handling and error-message generation during file-upload attempts, which allows remote attackers to execute arbitrary commands via a crafted Content-Type, Content-Disposition, or Content-Length HTTP header, as exploited in the wild in March 2017 with a Content-Type header containing a #cmd= string.

Source: MITRE Last Modified: 09/22/2017 [+View Analysis Description](#)

Impact

CVSS Severity (version 3.0):

CVSS v3 Base Score: 10.0 Critical

Vector: CVSS:3.0/AV:N/AC:L/PR:N/UI:N/S:C/C:H/I:H/A:H (legend)

Impact Score: 6.0

Exploitability Score: 3.9

Impact

CVSS Severity (version 3.0):

CVSS v3 Base Score: 10.0 Critical

Reported March 2017

Patched in struts 2.3.32 / 2.5.10.1 on 7th March

EQUIFAX TIMELINE

sources: <https://krebsonsecurity.com/2017/09/breach-at-equifax-may-impact-143m-americans/>
<https://www.usatoday.com/story/tech/2017/09/26/timeline-events-surrounding-equifax-data-breach/703691001/>

EQUIFAX TIMELINE

Equifax breach happened between mid-May and July

sources: <https://krebsonsecurity.com/2017/09/breach-at-equifax-may-impact-143m-americans/>
<https://www.usatoday.com/story/tech/2017/09/26/timeline-events-surrounding-equifax-data-breach/703691001/>

EQUIFAX TIMELINE

Equifax breach happened between mid-May and July

Equifax spotted it on July 29th

EQUIFAX TIMELINE

Equifax breach happened between mid-May and July

Equifax spotted it on July 29th

Reported on September 7th

EQUIFAX TIMELINE

Equifax breach happened between mid-May and July

Equifax spotted it on July 29th

Reported on September 7th

At the time the breach was discovered, the patch had been out for at least 2 months, and perhaps as long as 4 months

2 to 4 months

Hands up if you *know* you patch all your systems every 2-4 months?

PATCHING HYGIENE

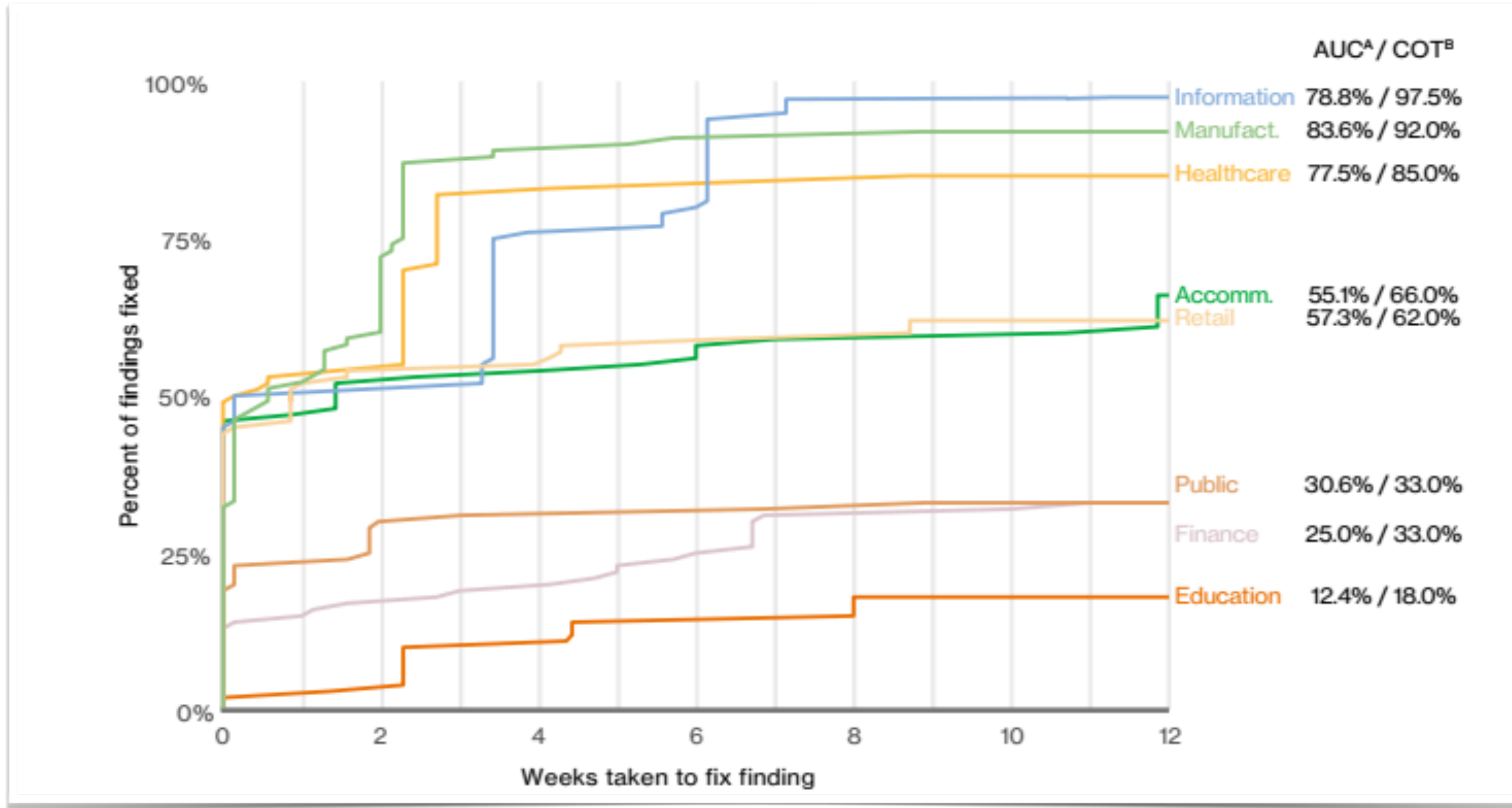

<http://www.verizonenterprise.com/verizon-insights-lab/dbir/2017/>



PATCHING MADNESS!

Underlying Hardware

PATCHING MADNESS!

Operating System

Underlying Hardware

PATCHING MADNESS!

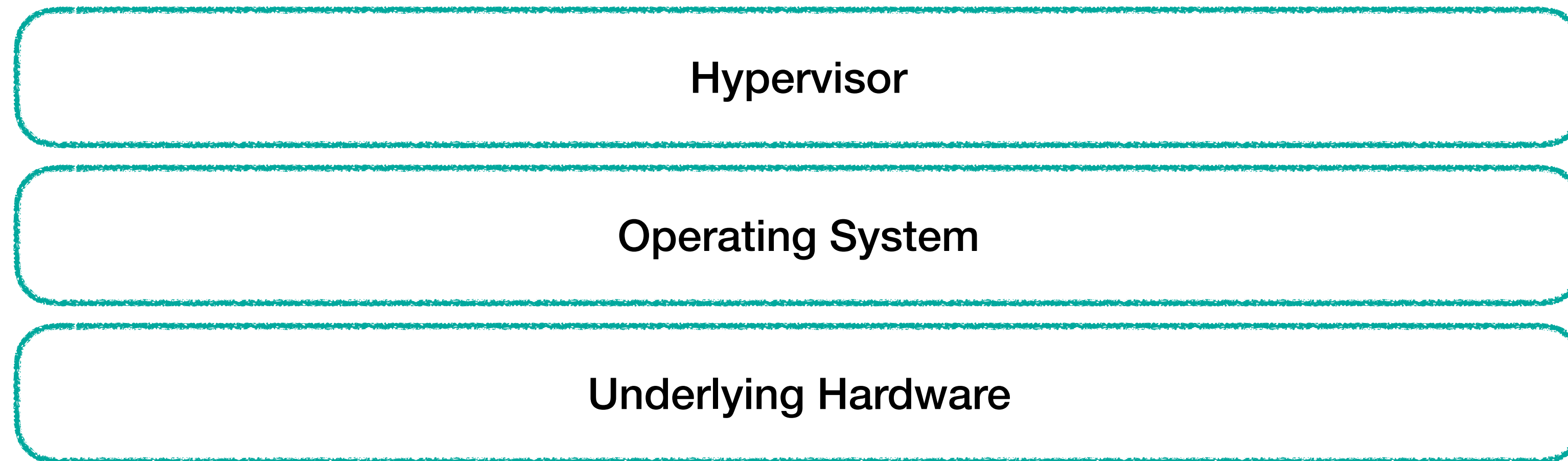

PATCHING MADNESS!

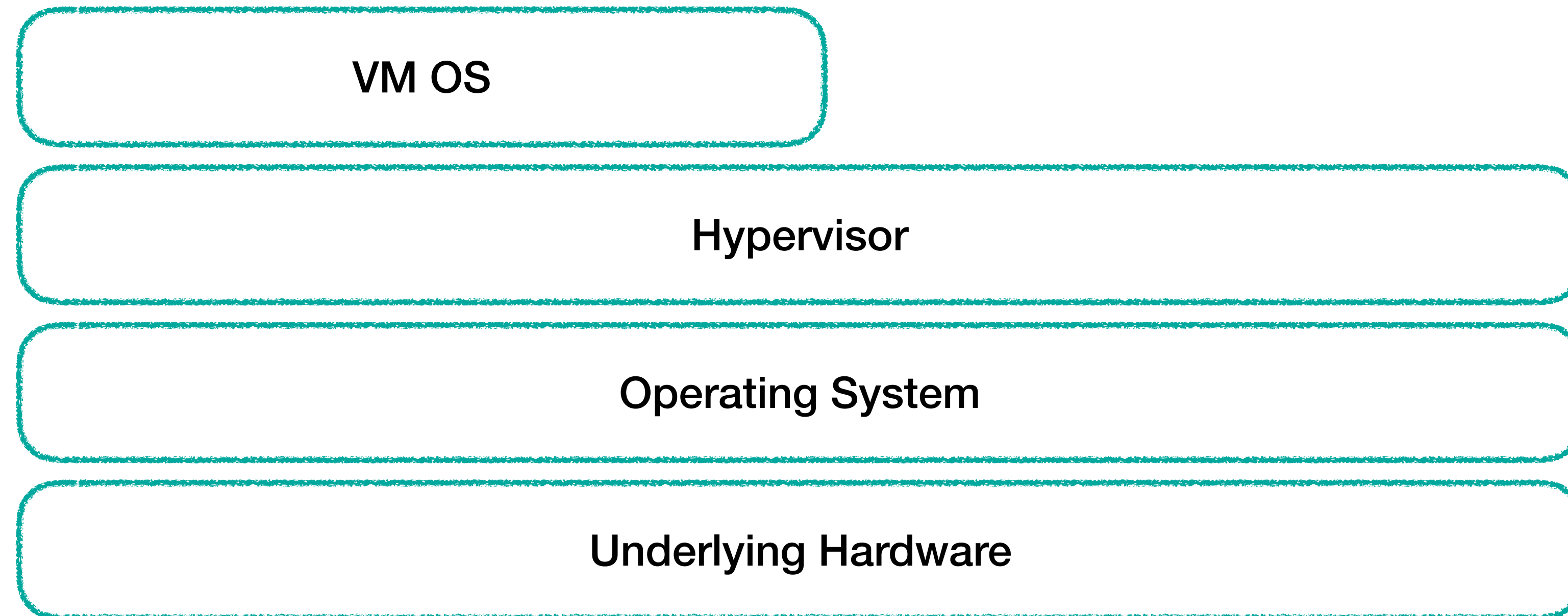

PATCHING MADNESS!

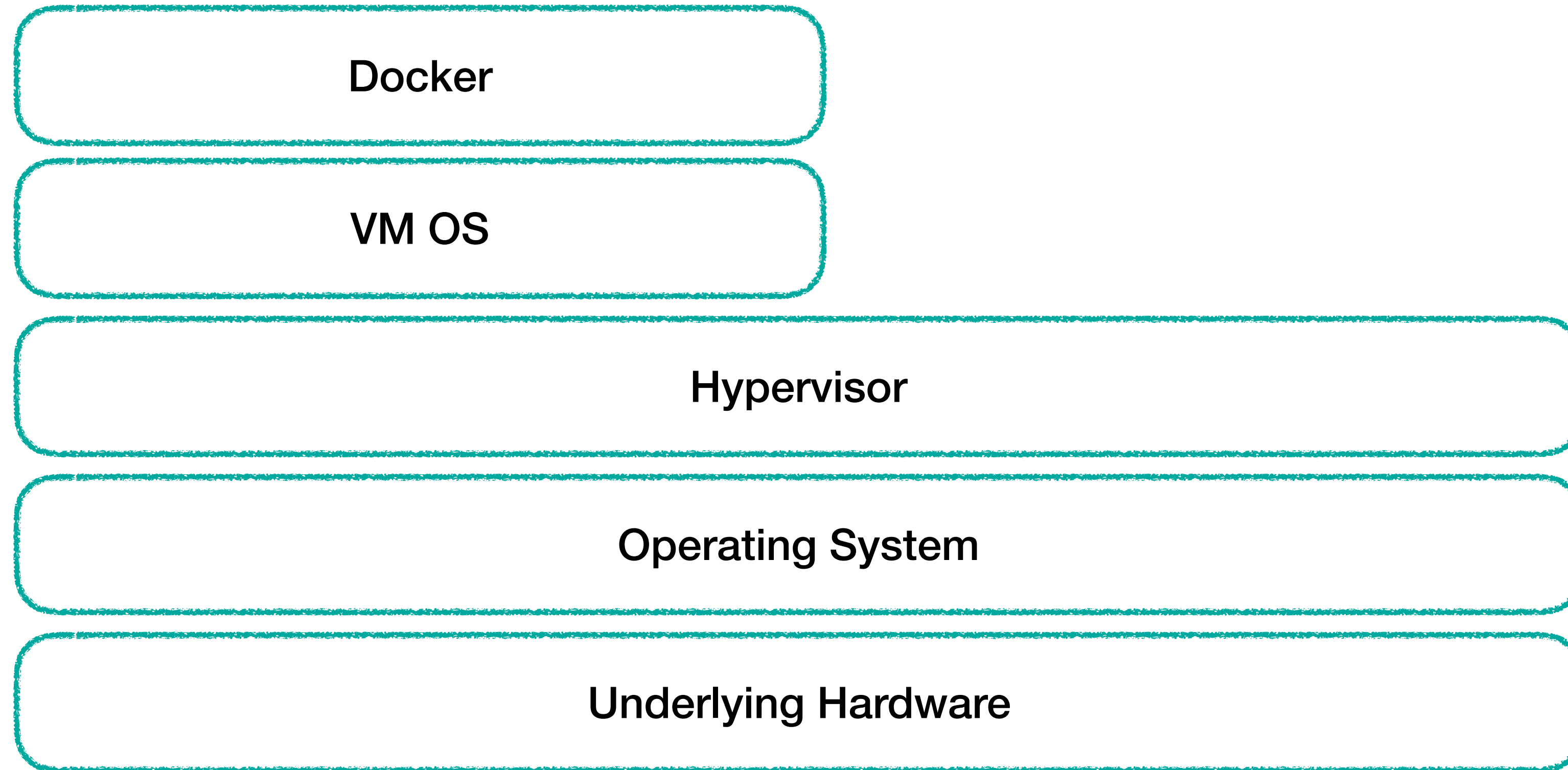

PATCHING MADNESS!

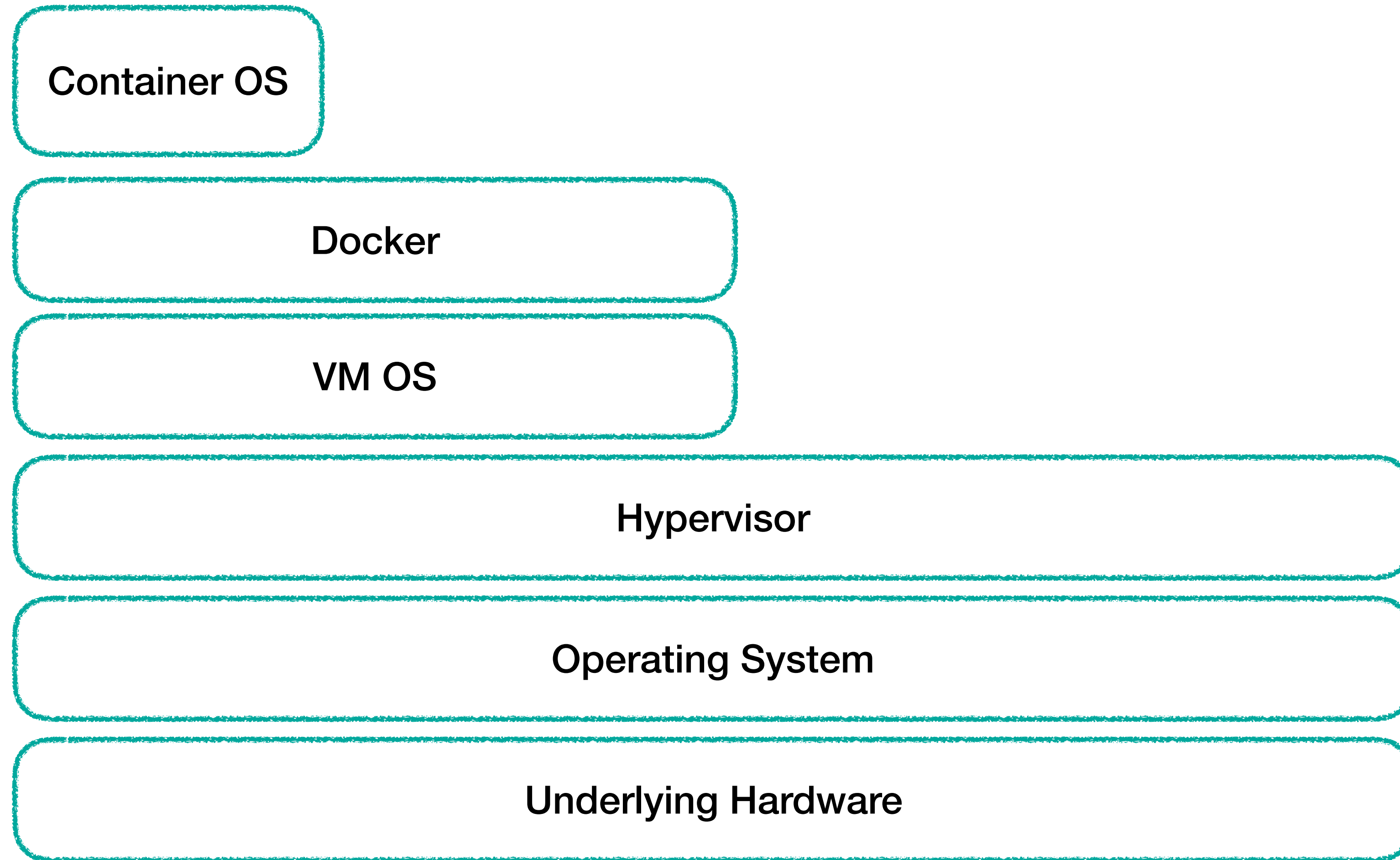

PATCHING MADNESS!

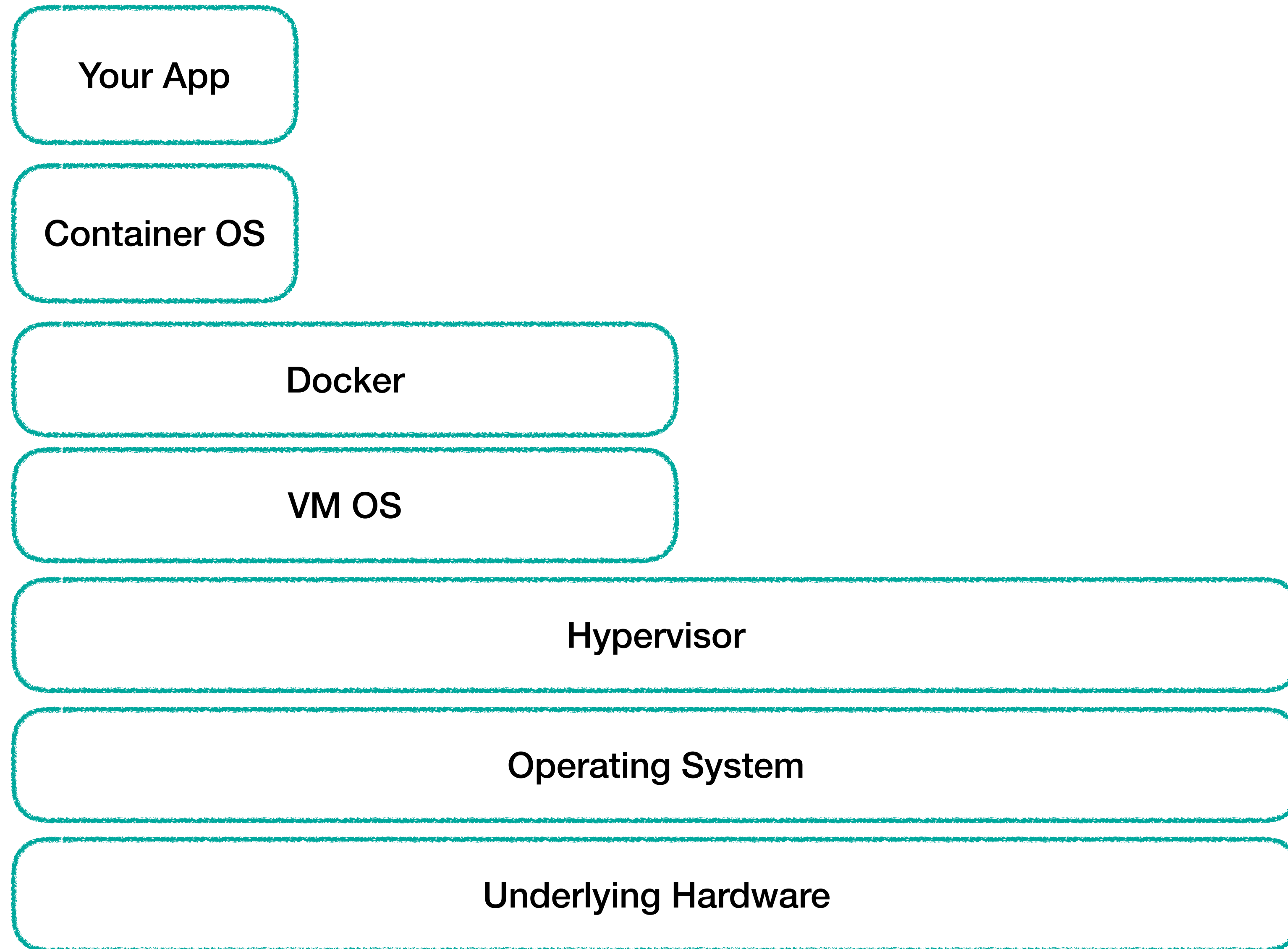

PATCHING MADNESS!

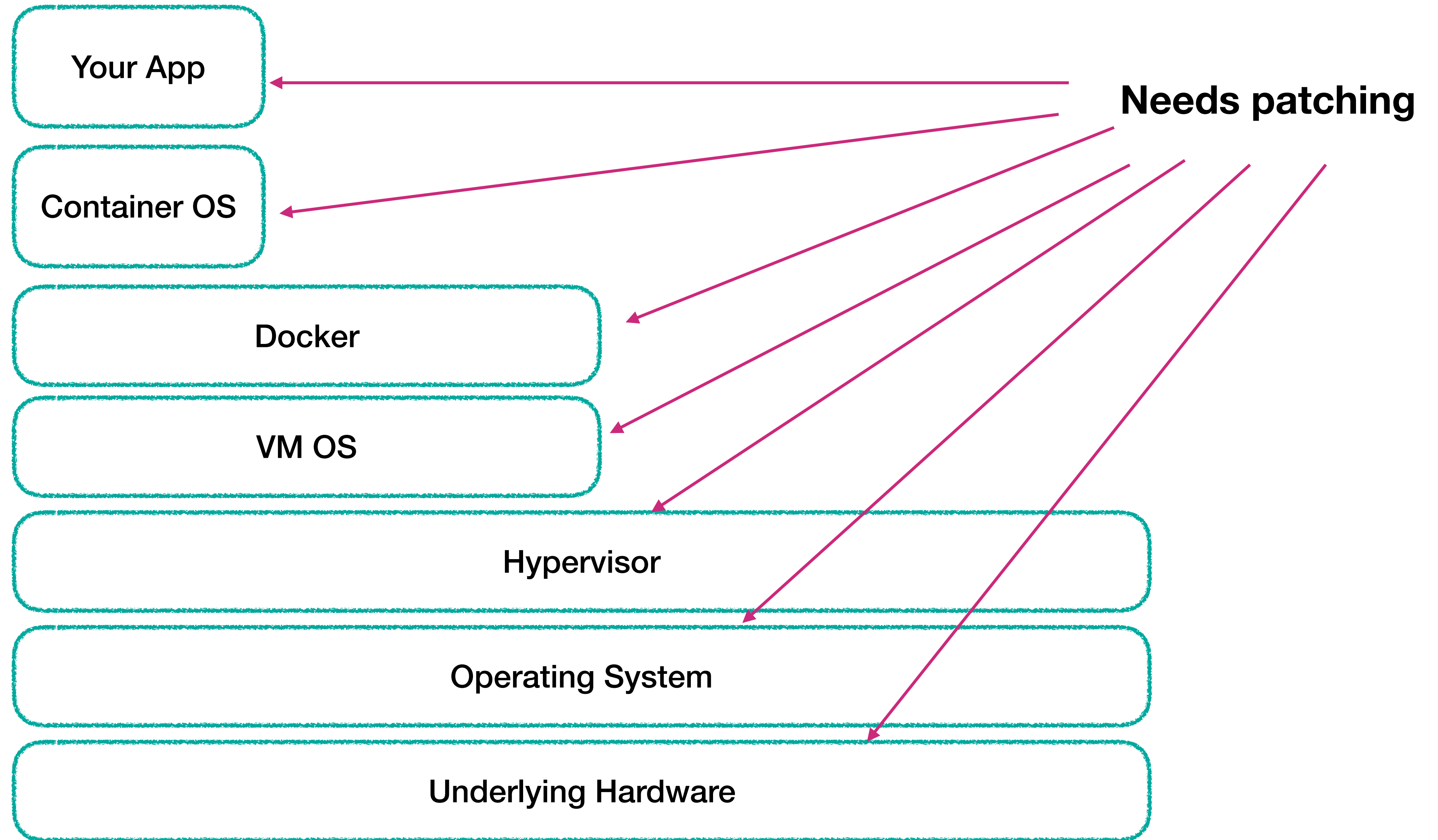

**So, how many of you are still sure you
apply every patch within 2-4 months?**

So what can you do about this?

BETTER ON THE CLOUD?

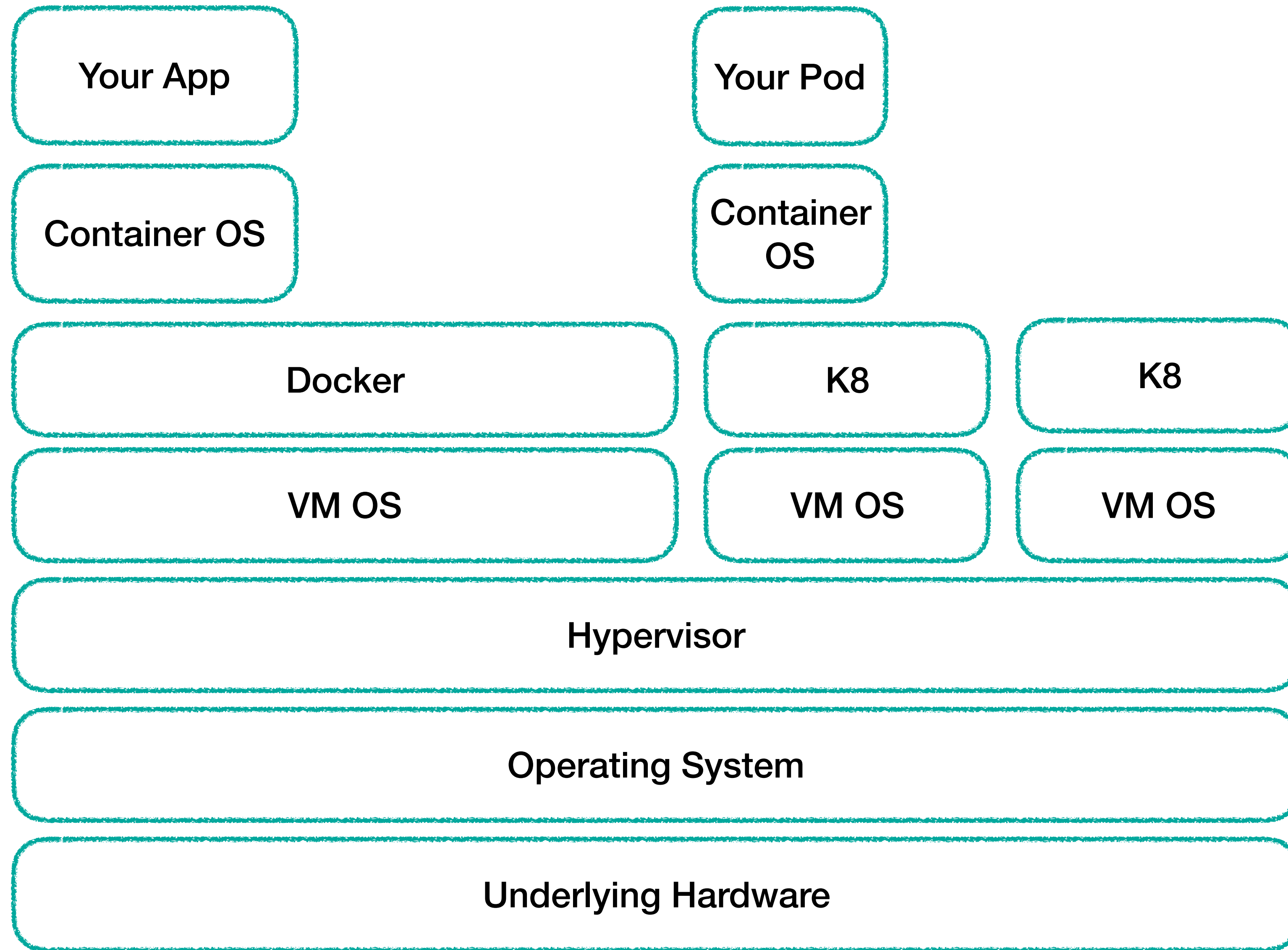

BETTER ON THE CLOUD?

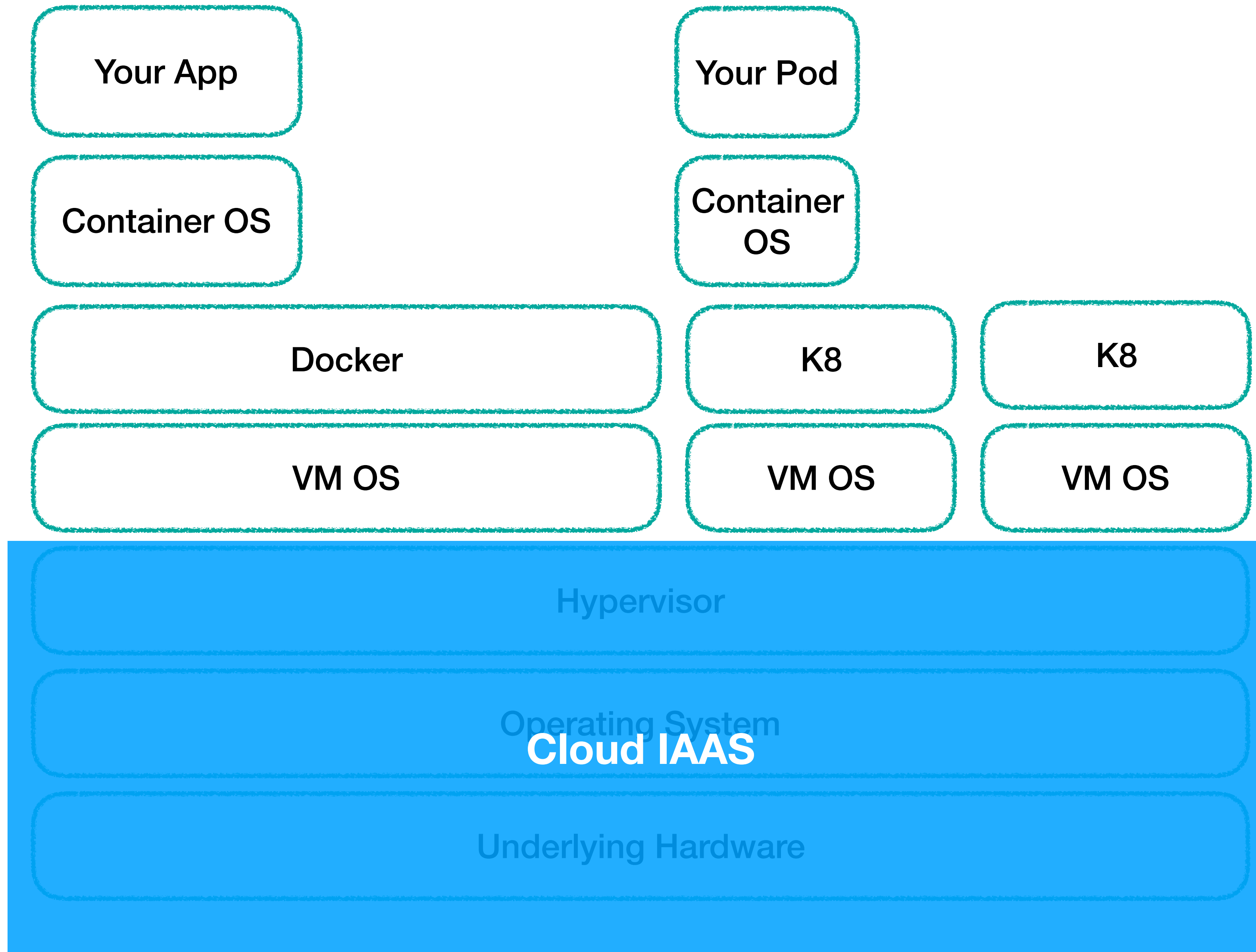

BETTER ON THE CLOUD?

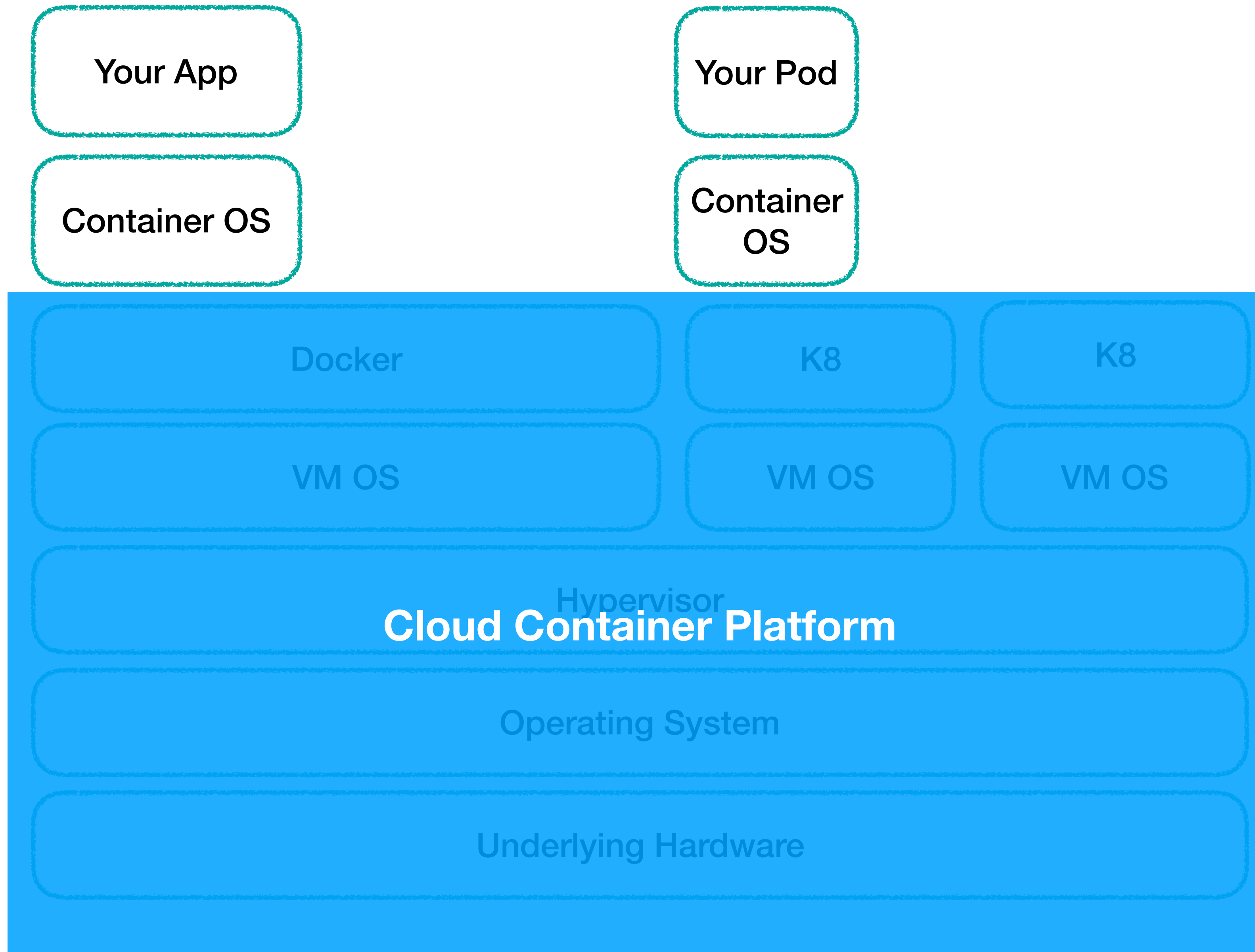

BETTER ON THE CLOUD?

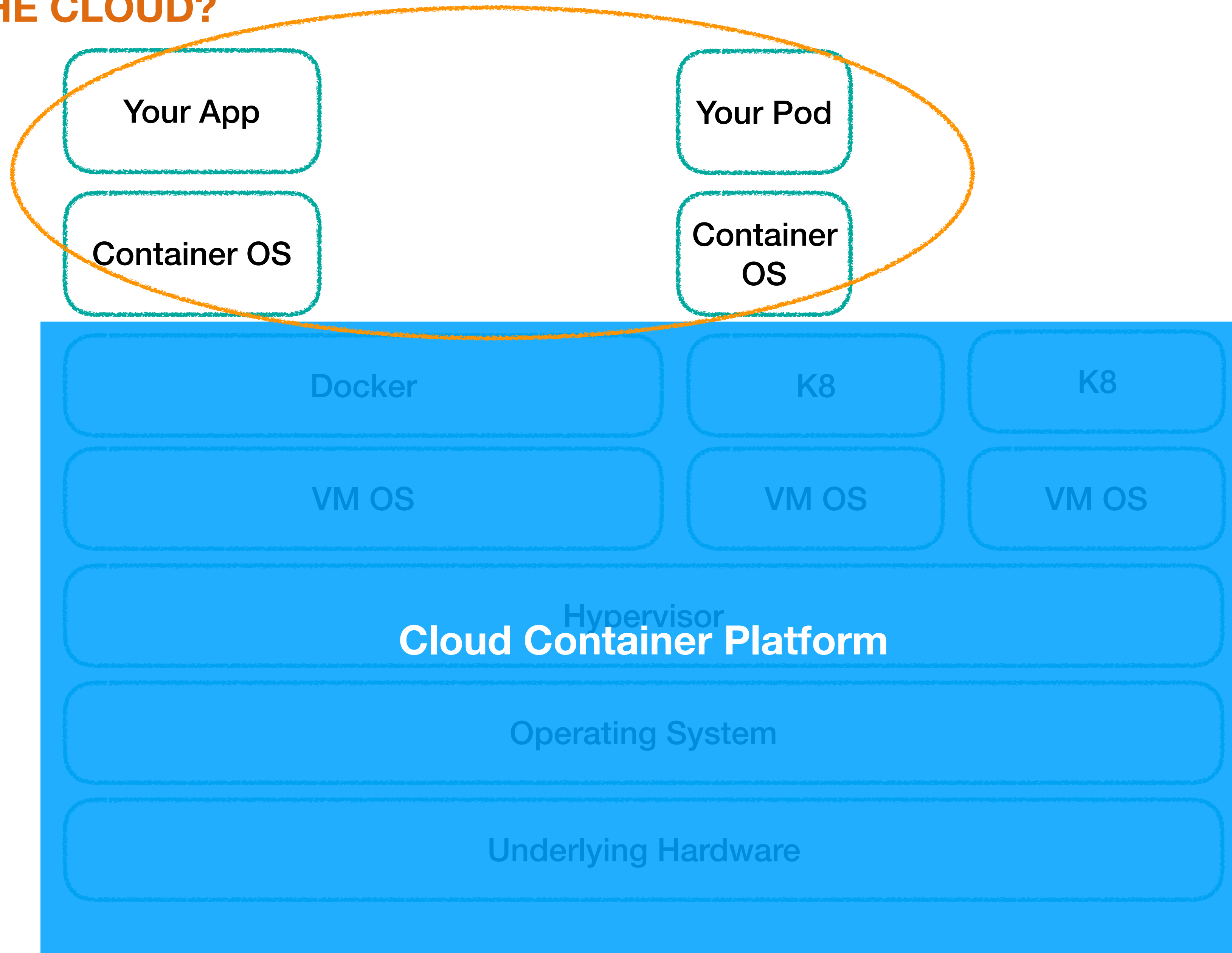

BETTER WITH FAAS?

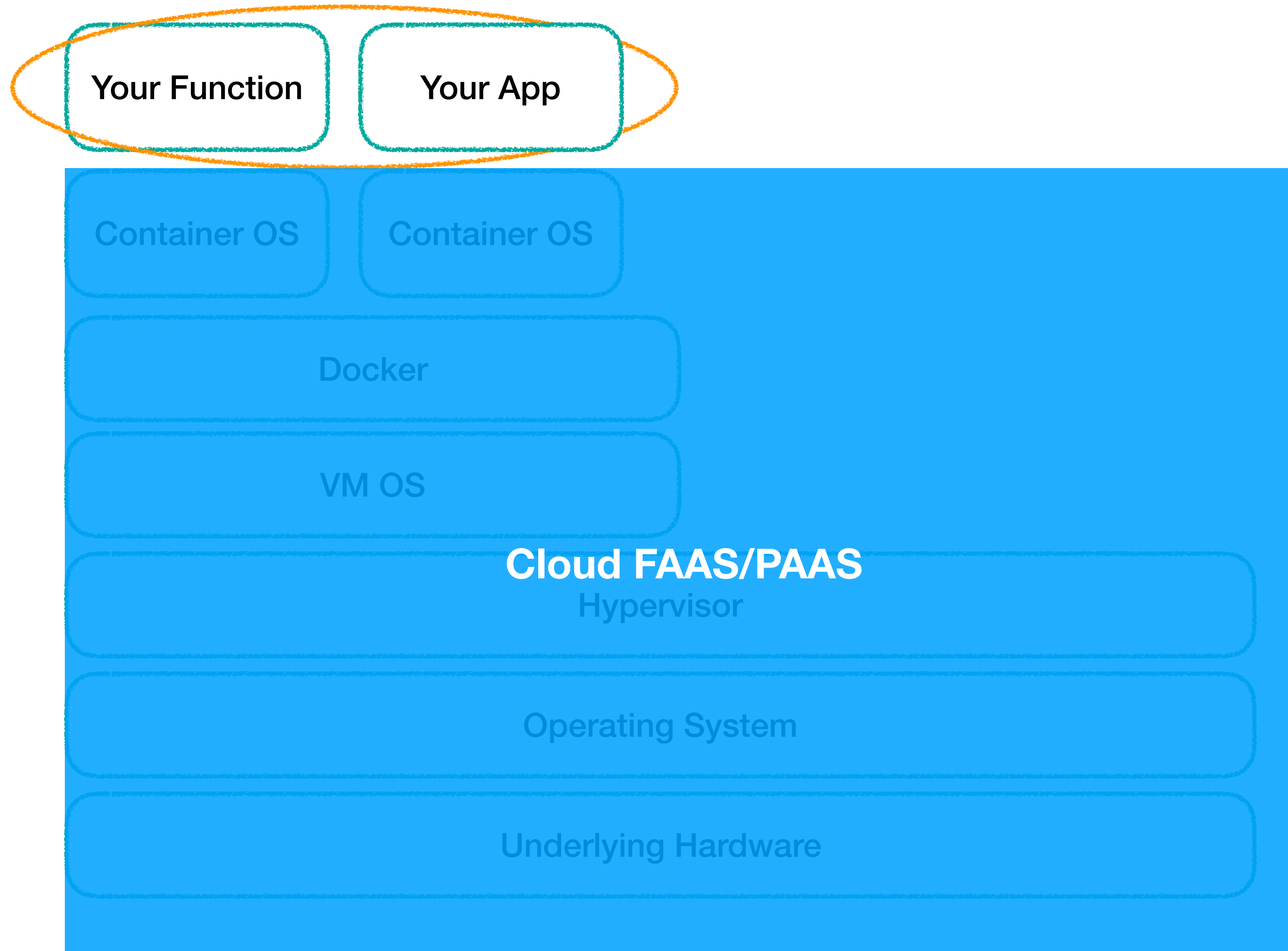

CONTAINER SCANNING

README.md

Clair

build passing container ready go report A+ godoc reference freenode #clair

Note: The `master` branch may be in an *unstable or even broken state* during development. Please use [releases](#) instead of the `master` branch in order to get stable binaries.



clair

Clair is an open source project for the [static analysis](#) of vulnerabilities in application containers (currently including [appc](#) and [docker](#)).

1. In regular intervals, Clair ingests vulnerability metadata from a configured set of sources and stores it in the database.
2. Clients use the Clair API to index their container images; this creates a list of *features* present in the image and stores them in the database.
3. Clients use the Clair API to query the database for vulnerabilities of a particular image; correlating vulnerabilities and features is done for each request, avoiding the need to rescan images.
4. When updates to vulnerability metadata occur, a notification can be sent to alert systems that a change has occurred.

Our goal is to enable a more transparent view of the security of container-based infrastructure. Thus, the project was named `Clair` after the French term which translates to *clear, bright, transparent*.

<https://github.com/coreos/clair>

CONTAINER SCANNING (CONT)

The screenshot displays the Aqua container scanning interface. The left sidebar contains navigation options: Dashboard, Images, Containers, Applications, Audit, and Administration (Policies, Hosts, Compliance, System). The main content area is titled "Repositories & Images > wordpress:latest" and includes tabs for Vulnerabilities, Packages, Metadata, and History. The "Image Overview" section shows a summary of vulnerabilities: 67 High, 121 Medium, 27 Low, and an Average Score of 5.8. Below this, a comparison is shown between the current image "wordpress:latest" (5 days ago, 402.75 MB) and the image it is based on, "php:5.6-apache" (7 days ago, 373.83 MB). The current image has 67 High, 121 Medium, and 27 Low vulnerabilities, while the base image has 55 High, 105 Medium, and 27 Low vulnerabilities. A table below lists specific vulnerabilities:

NAME	SCORE	SEVERITY	PUBLISH DATE
> CVE-2016-4448	10	High	2016
> CVE-2016-1761	10	High	2016
> CVE-2014-9495	10	High	2015-01-10

<https://www.aquasec.com>

MONITOR OUTDATED DEPENDENCIES

The image shows a screenshot of the Snyk website. The top navigation bar includes links for Test, Vulnerability DB, Docs, Blog, Features, Partners, Pricing, Log in, and a Sign up button. The main header features the Snyk logo (a dog's head) and the text: "Snyk continuously finds and fixes vulnerabilities in your dependencies. Protect and monitor your JavaScript, Ruby and Java apps".

Below the header, there are two main sections:

- Source code protection:** Find vulnerabilities in your GitHub repositories and remediate risks with updates and patches. Add Snyk to your CI/CD process with support for Jenkins, Circle CI, Travis and more. A button "Quick start with GitHub" is present.
- New! Serverless & PaaS monitoring:** Continuously monitor your runtime apps. Get Snyk security alerts and deploy critical updates. Support for Heroku, AWS Lambda and more. A button "Sign up for a free account" is present.

Logos for GitHub, Bitbucket, Travis CI, Jenkins, Heroku, and Amazon Web Services are displayed below these sections.

At the bottom left, a statistic states: "83% of Snyk users found security issues in their dependencies". Below this, it says "We can help you find, fix, and prevent vulnerabilities:" followed by a list of benefits:

- Automatically test your applications dependencies
- Fix security risks with upgrades and patches
- Prevent you from adding vulnerable dependencies
- Stay alert about new vulnerabilities

A link "Find out how" is provided below the list.



On the bottom right, a snippet of the Snyk dashboard is shown, displaying a list of projects with their respective vulnerability counts and status indicators.

<https://snyk.io/>

AUTOMATICALLY PATCH APP DEPENDENCIES

[Snyk Update] New fixes for 25 vulnerable dependency paths #1

 Open `snyk-bot` wants to merge 1 commit into `master` from `snyk-fix-836b436e`

 Conversation 0  Commits 1  Files changed 2

 `snyk-bot` commented an hour ago First-time contributor + 😊 ✎

This project has vulnerabilities that could not be fixed, or were patched when no upgrade was available. Good news, new upgrades or patches have now been published! This pull request fixes vulnerable dependencies you couldn't previously address.

The PR includes:

- Changes to `package.json` to upgrade the vulnerable dependencies to a fixed version.

<https://snyk.io/>

DO SOME THREAT MODELLING

Life in the Digital Crosshairs
Experience the Untold Story
[Learn more →](#)

What is the Security Development Lifecycle ?

The Security Development Lifecycle (SDL) is a software development process that helps developers build more secure software and address security compliance requirements while reducing development cost

Training Requirements Design Implementation Verification Release Response

Click to select a phase

Design Phase

SDL Practice #5: Establish Design Requirements

Considering security and privacy concerns early helps minimize the risk of schedule disruptions and reduce a project's expense.

Assess your security

Discover ways to improve your security practices.

[Get Started](#)

Tools

- [Attack Surface Analyzer 1.0](#)
Understand your attack surface before & after new apps are deployed.
- [Microsoft Threat Modeling Tool 2014](#)
A tool to help engineers find and address system security issues.
- [MiniFuzz basic file fuzzing tool](#)
A simple fuzzer designed to ease adoption of fuzz testing.
- [Regular expression file fuzzing tool](#)
A tool to test for potential denial of service vulnerabilities.

<https://www.microsoft.com/en-us/sdl/>

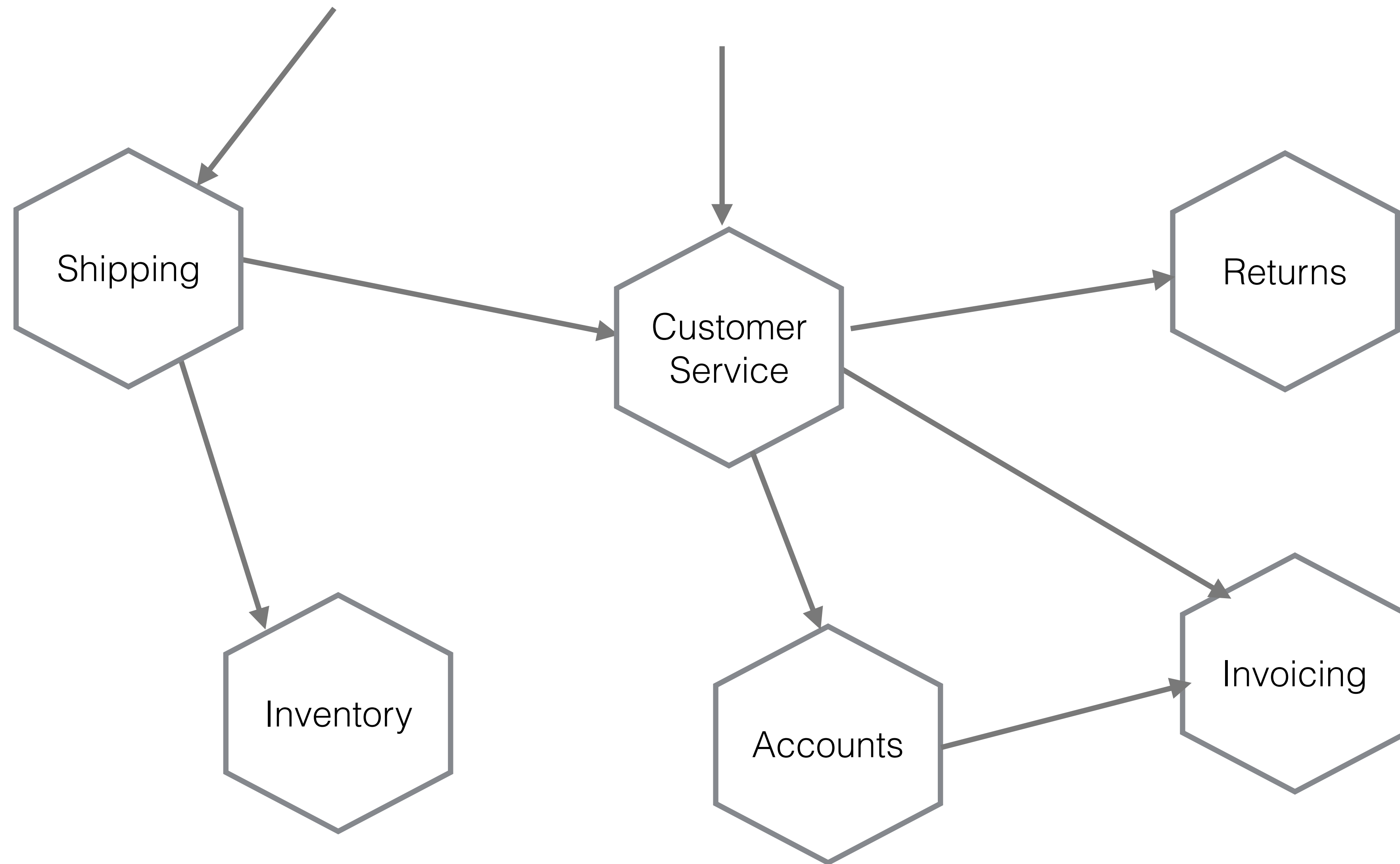

J A S O N S T A T H A M

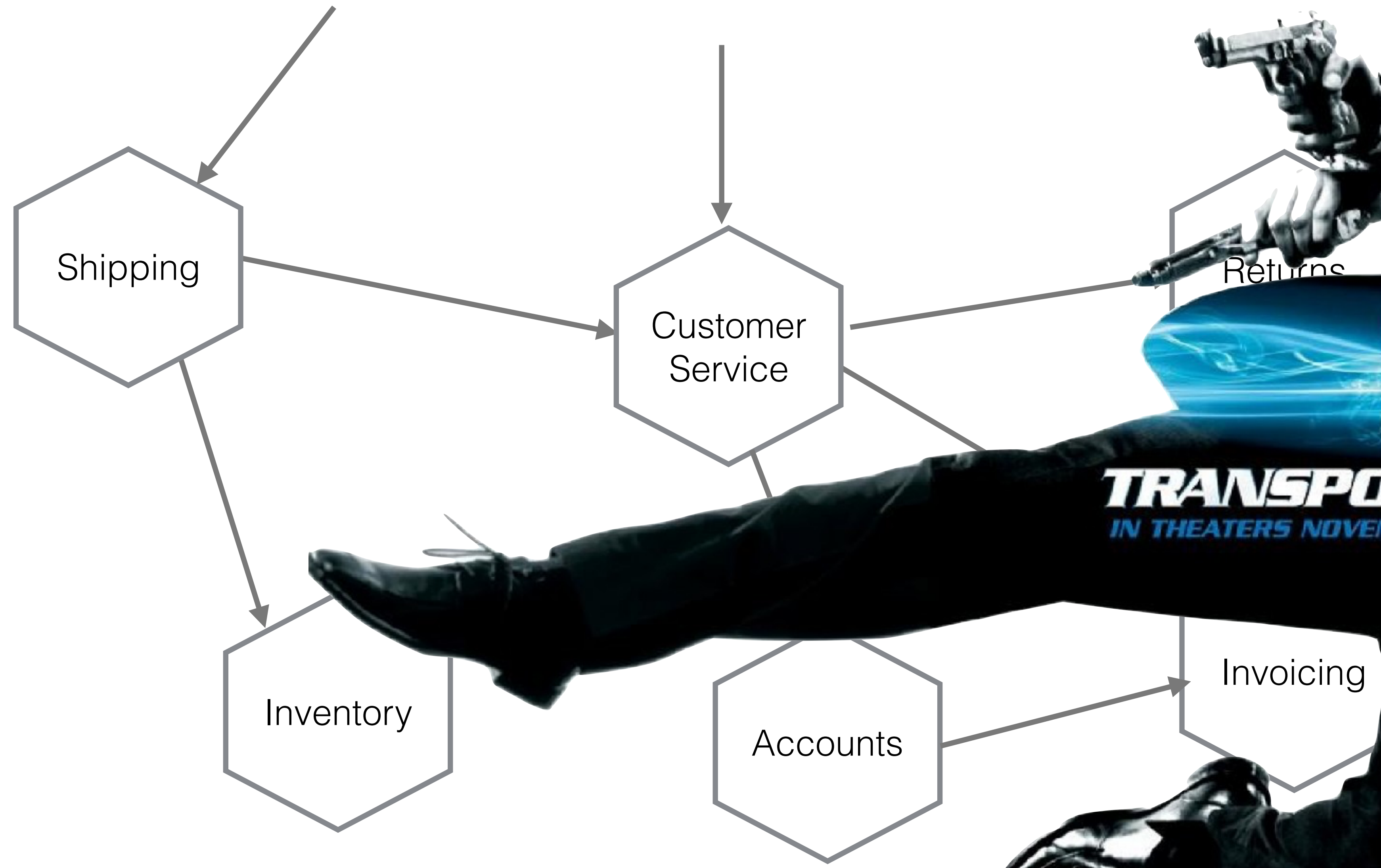

TRANSPORTER 3
IN THEATERS NOVEMBER 26TH

© Lions Gate 2008, All Rights Reserved

© Lions Gate 2008, All Rights Reserved

@samnewman

MUSIC CORP 2018

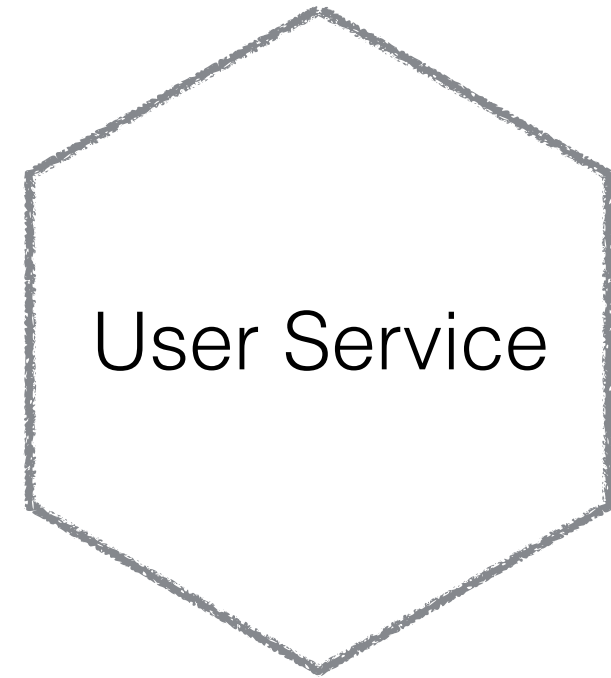

MUSIC CORP 2018

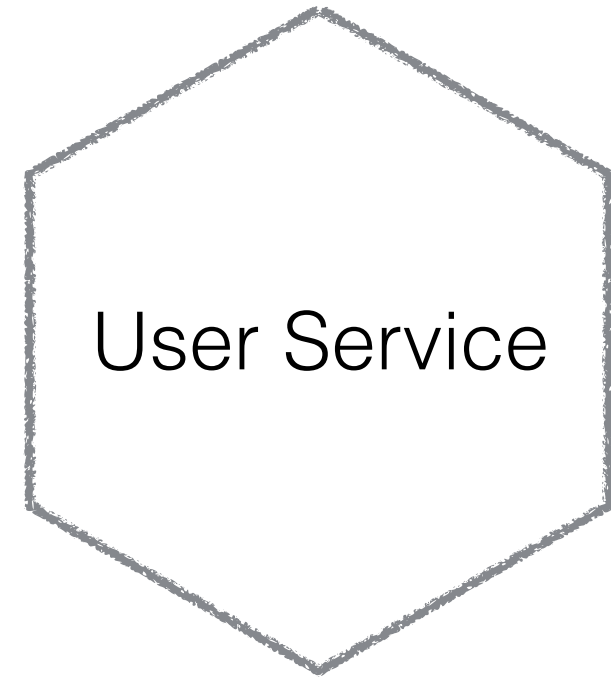

MUSIC CORP 2018

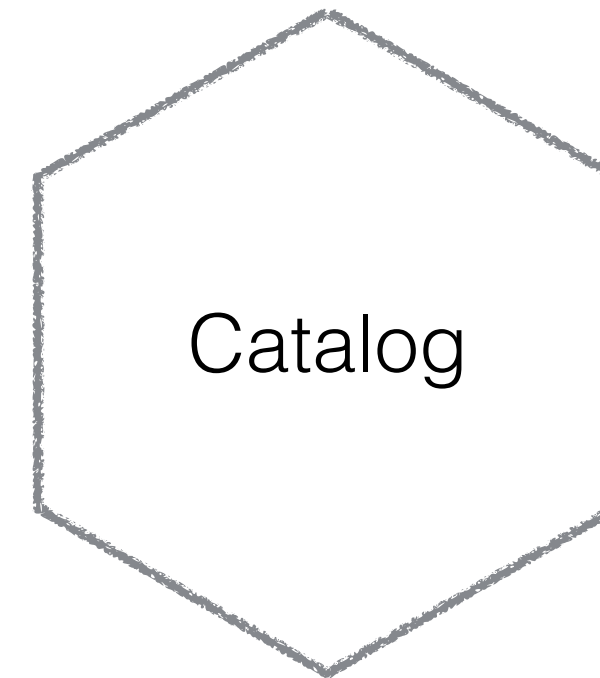
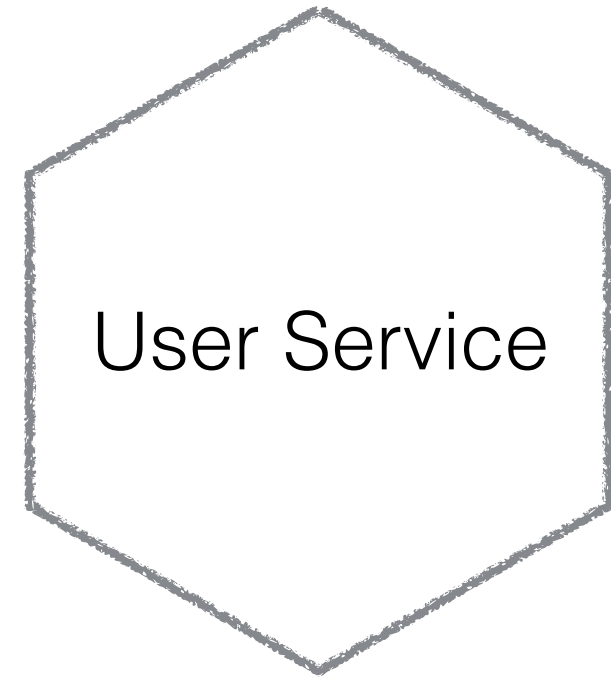

MUSIC CORP 2018

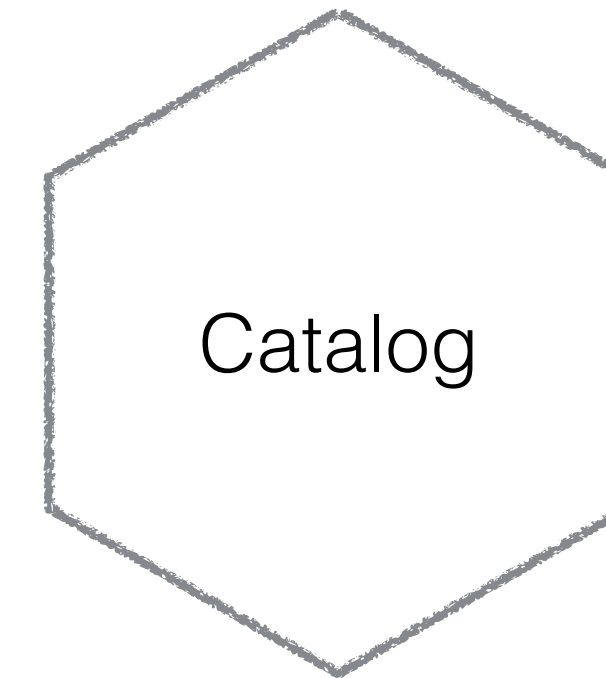
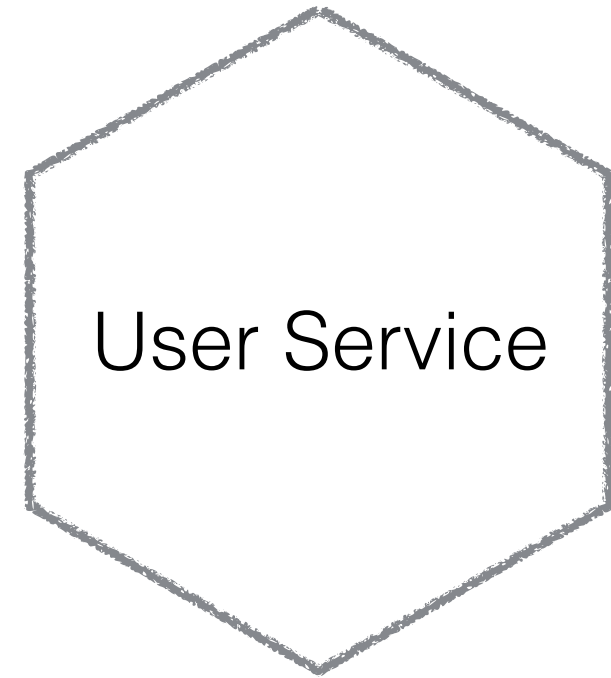

MUSIC CORP 2018

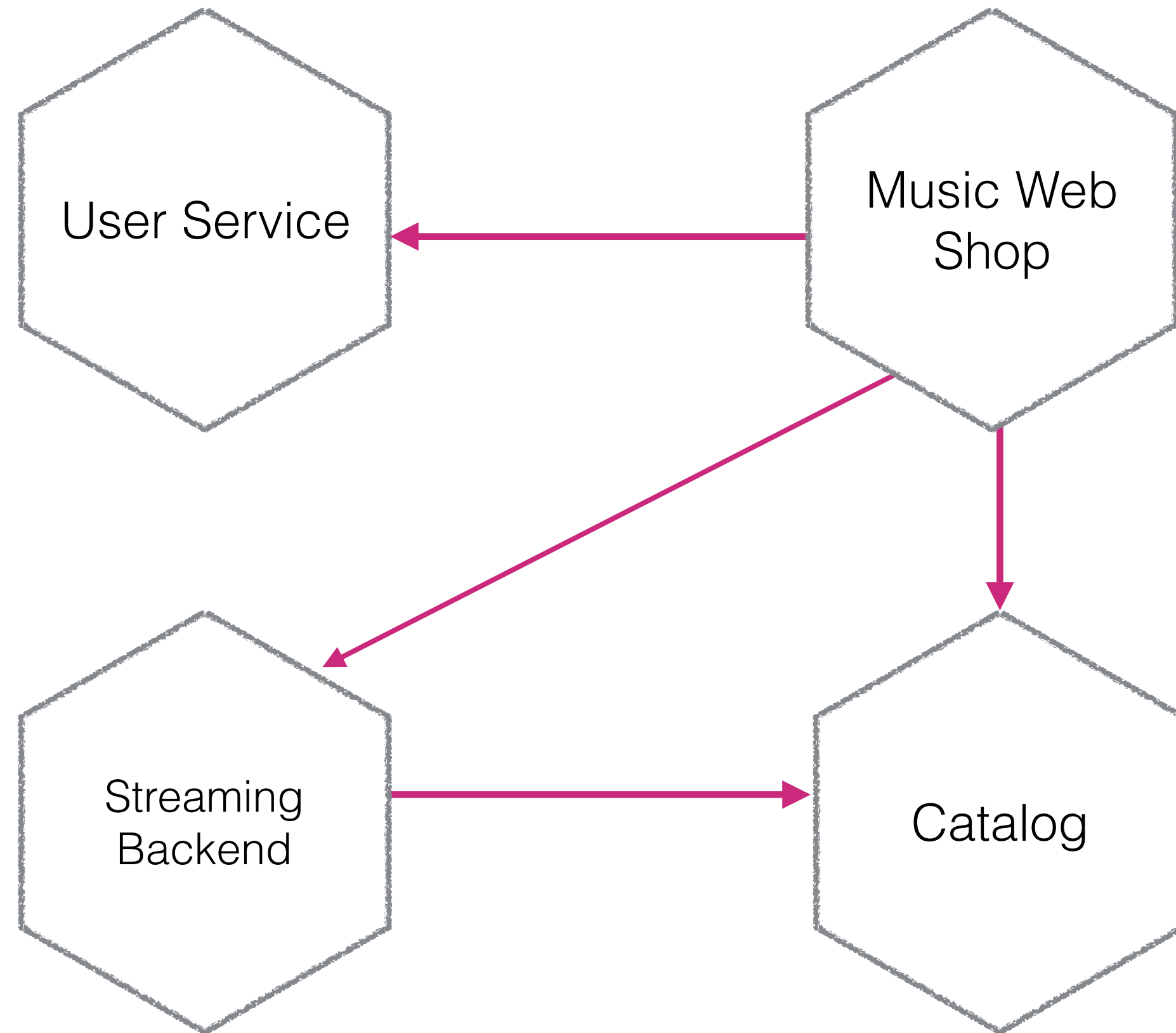

MUSIC CORP 2018

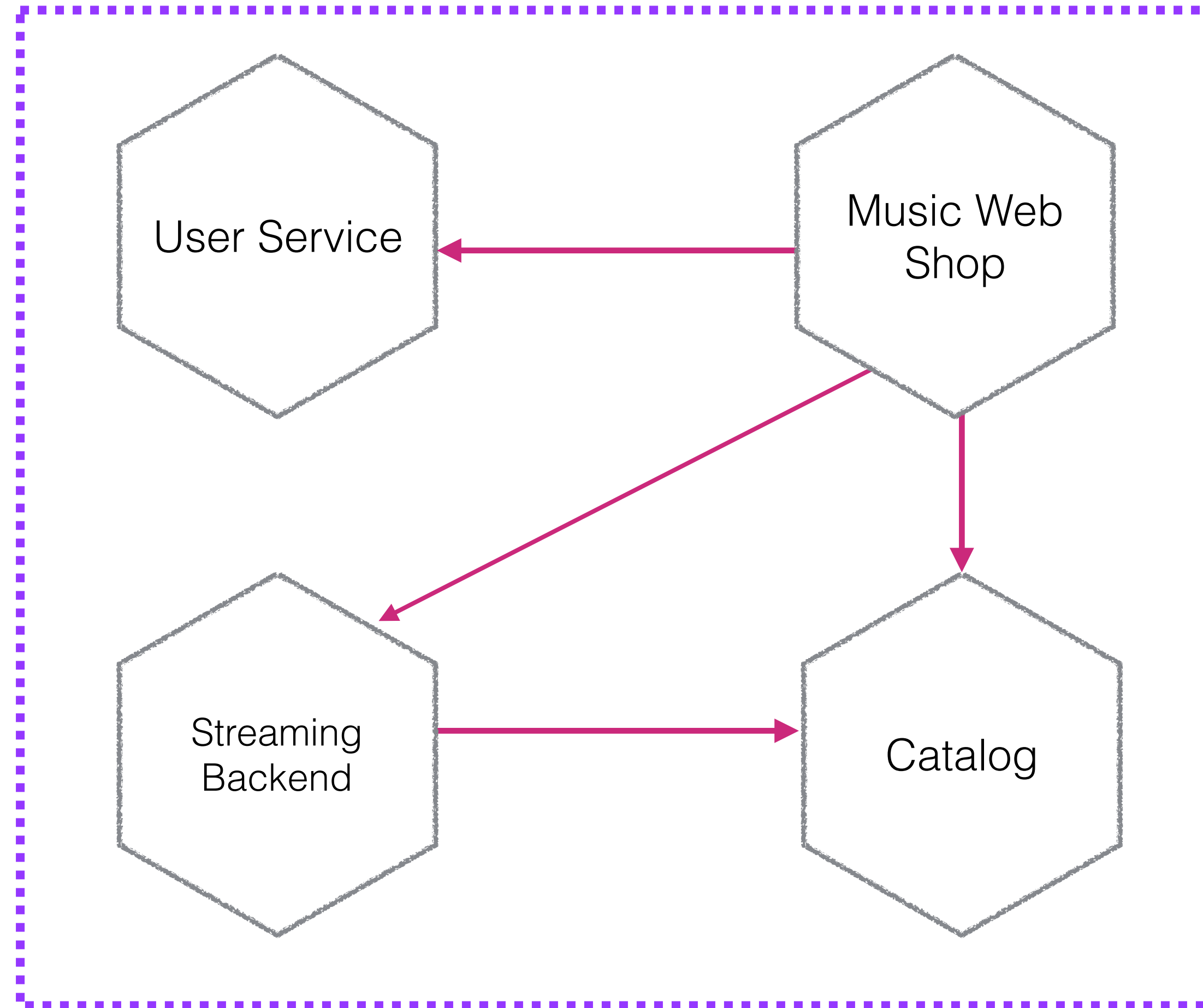

MUSIC CORP 2018

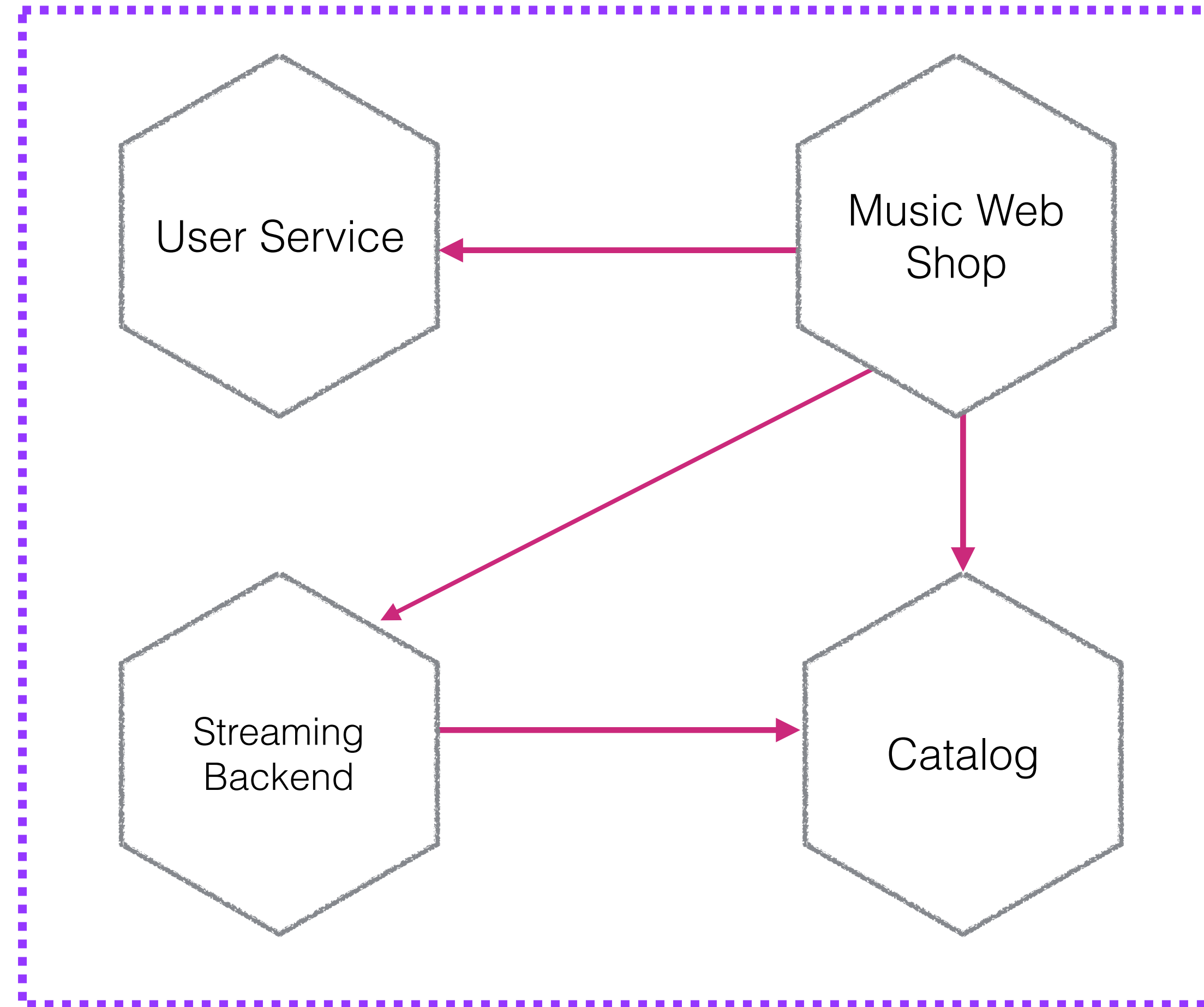

Native Mobile

MUSIC CORP 2018

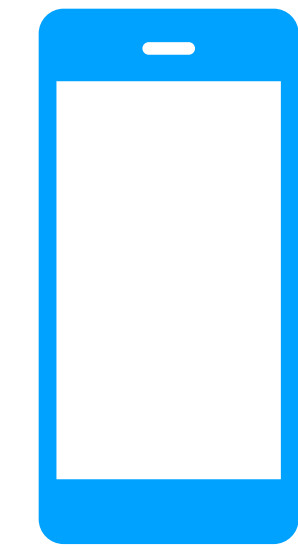
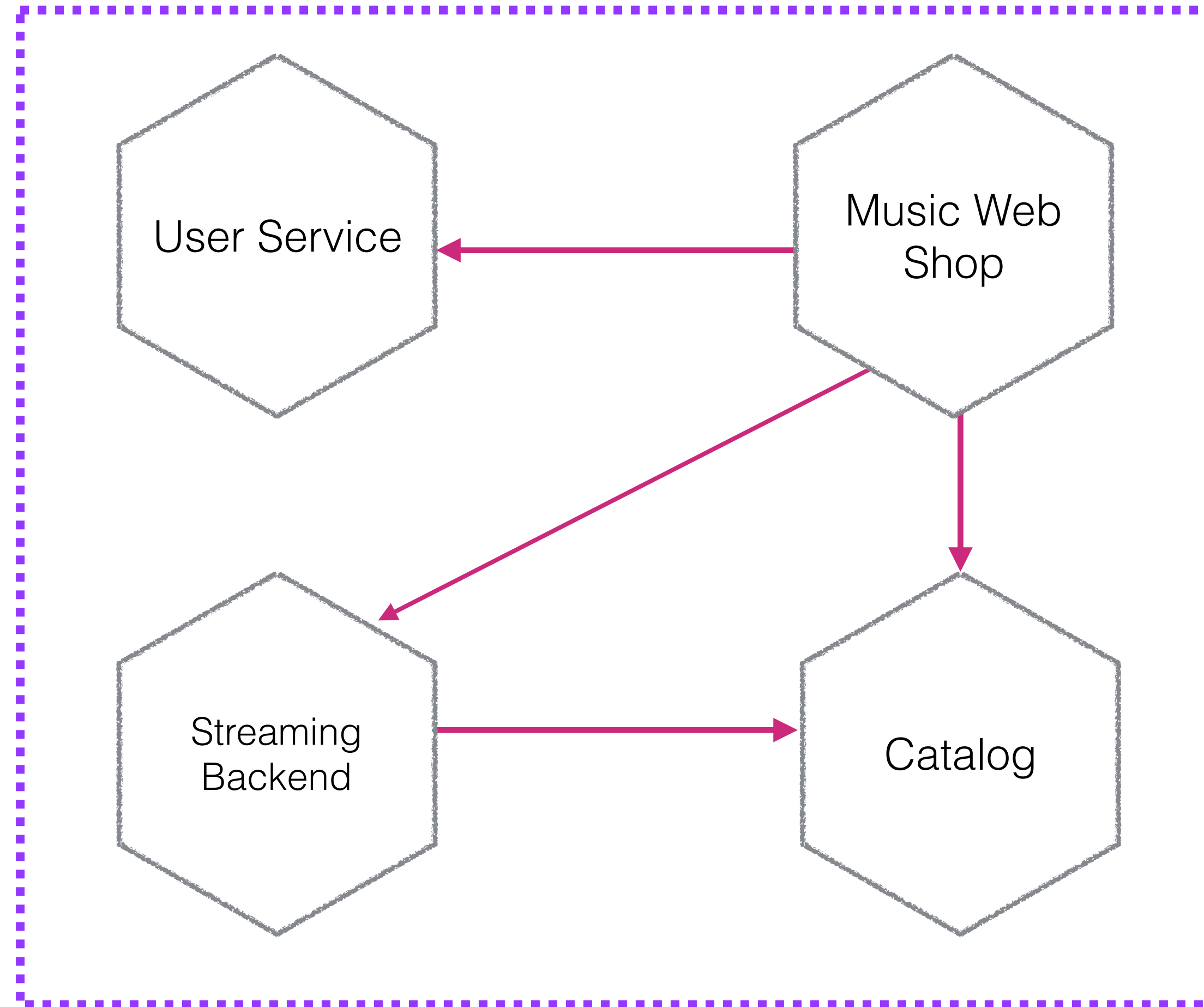

Native Mobile



Web

MUSIC CORP 2018

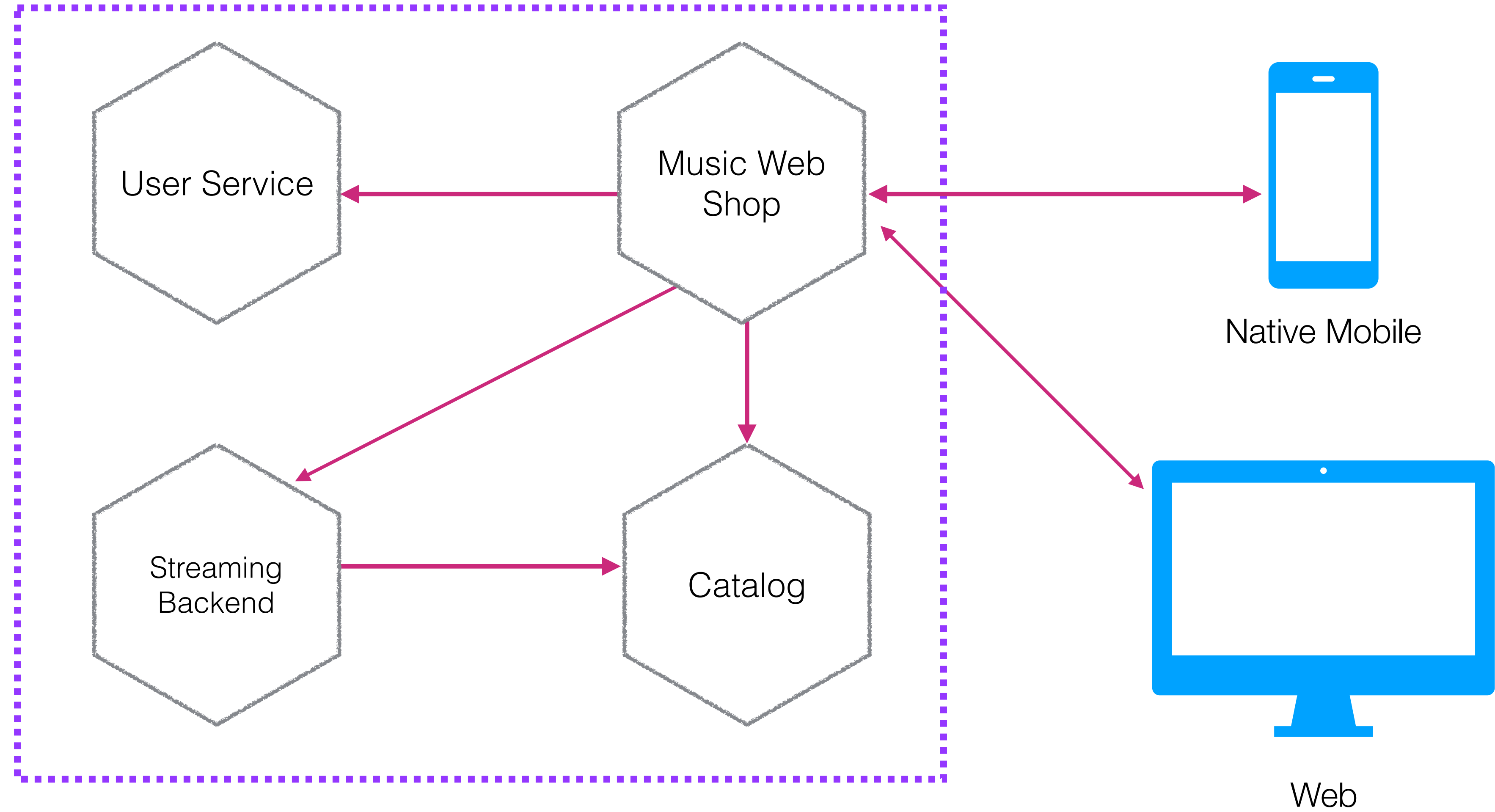

MUSIC CORP 2018

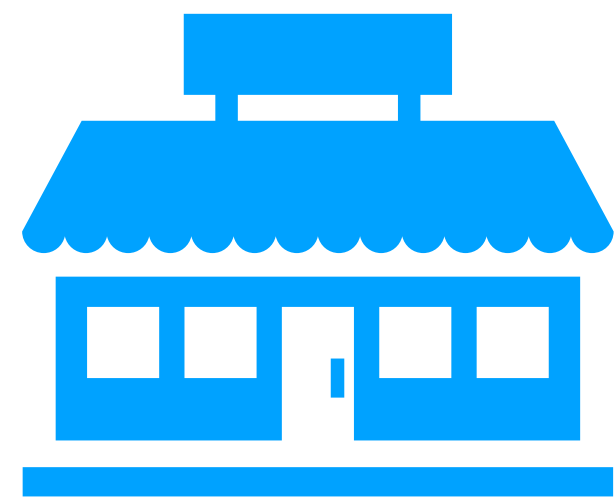

RoyaltyCo

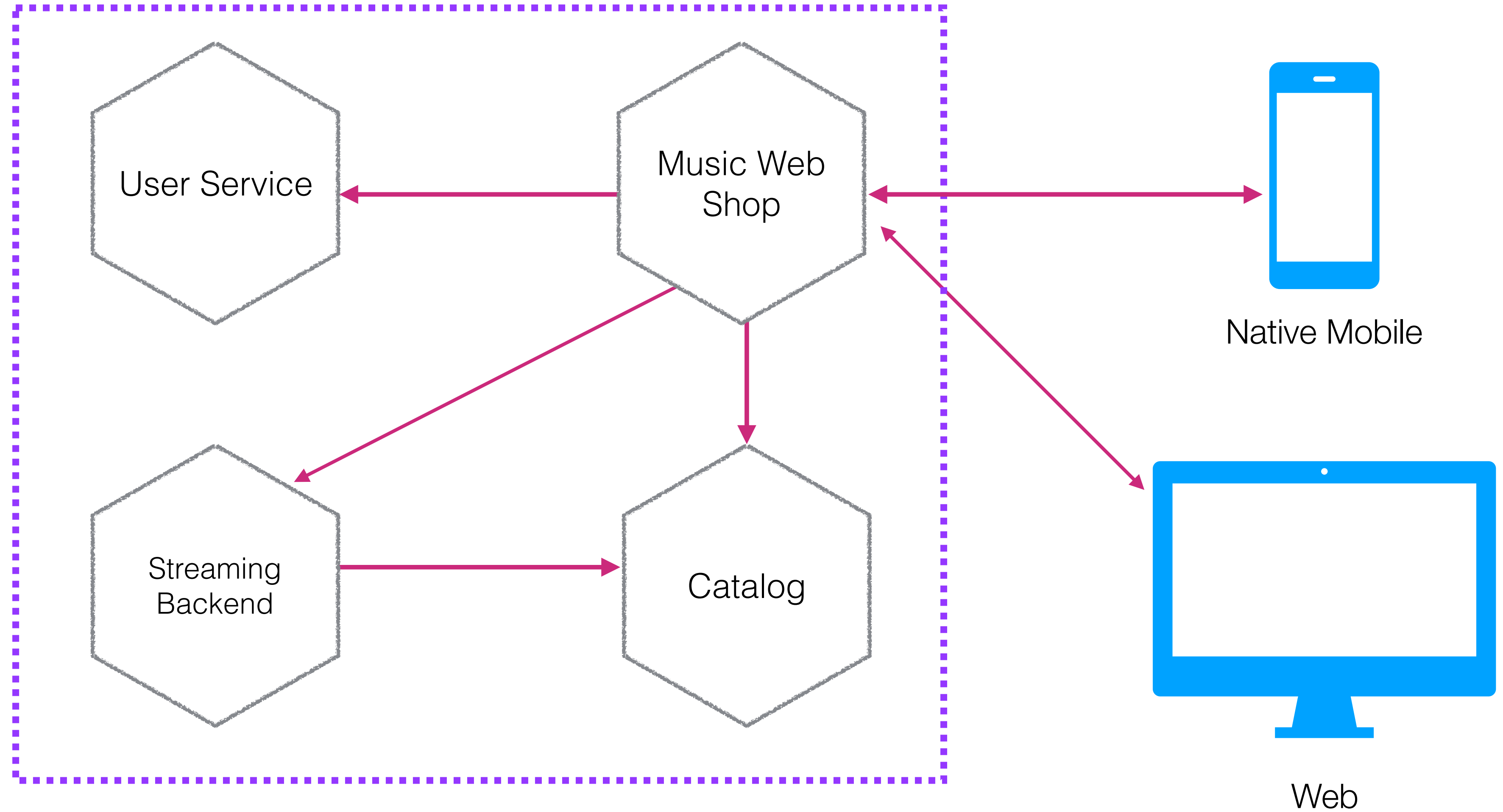

MUSIC CORP 2018

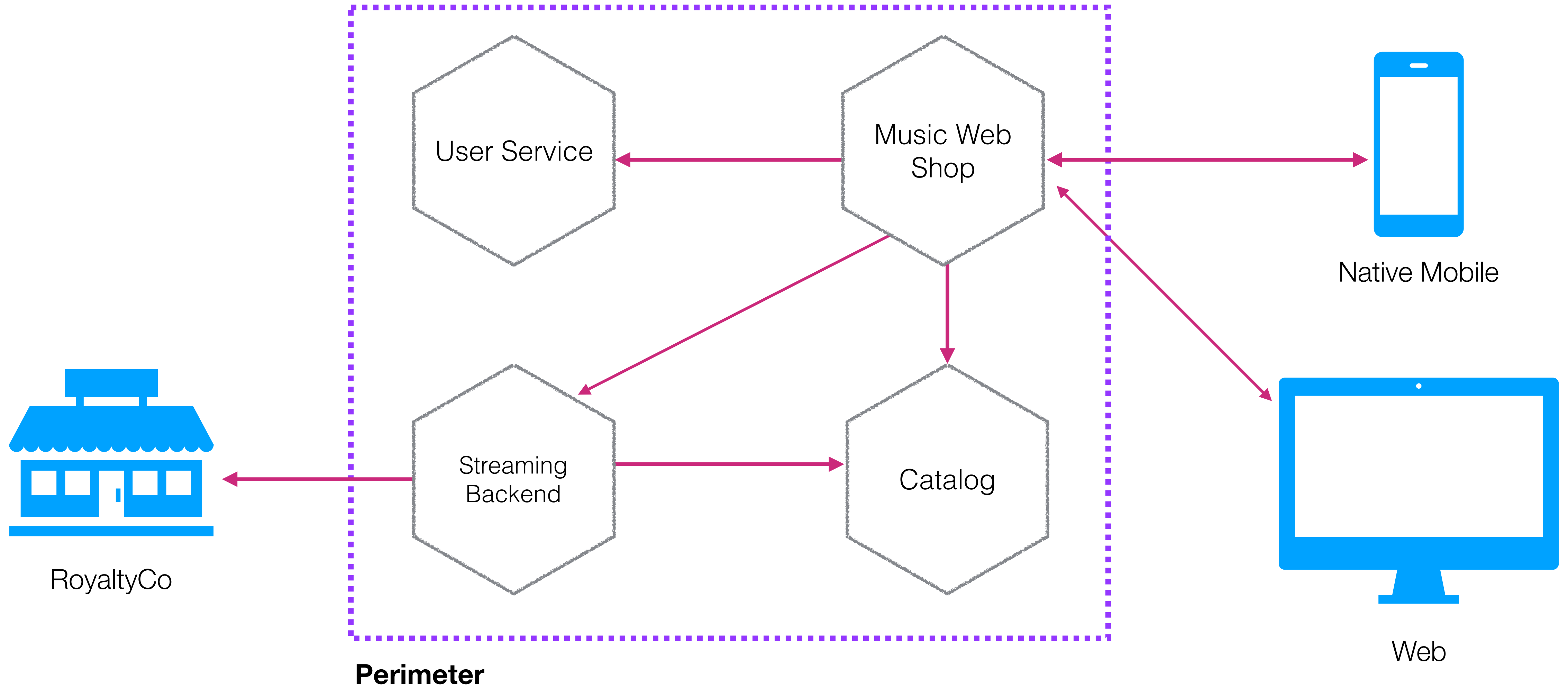

KEY CONCERNS OF TRANSPORT SECURITY

KEY CONCERNS OF TRANSPORT SECURITY

Observation of data

KEY CONCERNS OF TRANSPORT SECURITY

Observation of data

Manipulation of data

KEY CONCERNS OF TRANSPORT SECURITY

Observation of data

Manipulation of data

Restricting access to endpoints

KEY CONCERNS OF TRANSPORT SECURITY

Observation of data

Manipulation of data

Restricting access to endpoints

Impersonation of endpoints

HTTPS Everywhere!

HTTP + TLS

Server guarantees!

Server guarantees!

Payload not manipulated

Server guarantees!

Payload not manipulated

Client guarantees?

Server guarantees!

Payload not manipulated

Client guarantees?

Certificate management can be painful

LET'S ENCRYPT

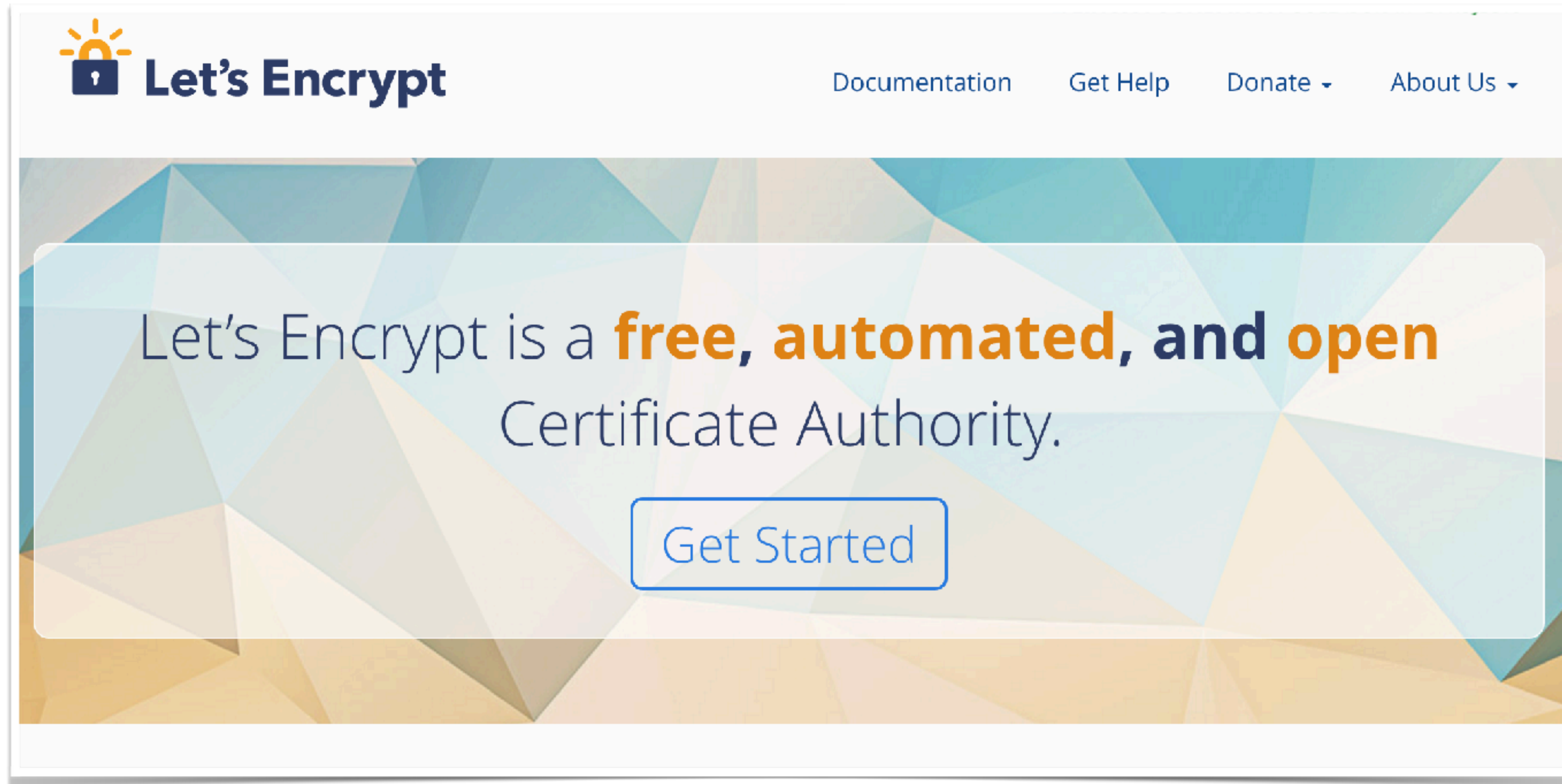

The screenshot shows the homepage of the Let's Encrypt website. At the top left is the Let's Encrypt logo, which consists of a sun icon with rays and a padlock icon, followed by the text "Let's Encrypt". To the right of the logo is a navigation menu with four items: "Documentation", "Get Help", "Donate" (with a downward arrow), and "About Us" (with a downward arrow). The main content area features a large, semi-transparent white box with a blue border. Inside this box, the text reads: "Let's Encrypt is a **free, automated, and open** Certificate Authority." Below this text is a blue button with the text "Get Started". The background of the page is a colorful, abstract geometric pattern of triangles in shades of blue, green, and orange.

<https://letsencrypt.org/>

LET'S ENCRYPT

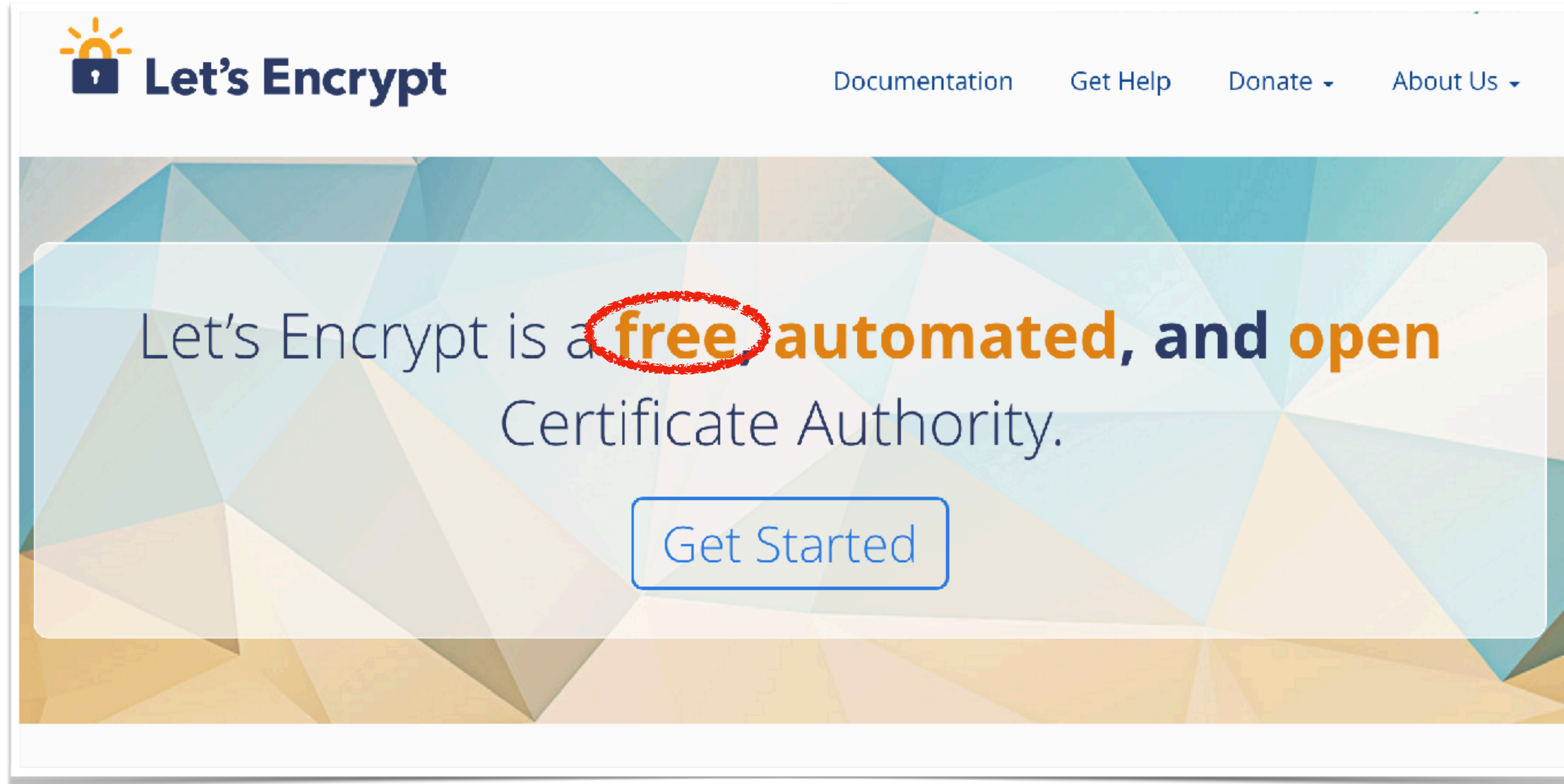

<https://letsencrypt.org/>

LET'S ENCRYPT

Let's Encrypt is a **free, automated, and open** Certificate Authority.

[Get Started](#)

Documentation Get Help Donate About Us

<https://letsencrypt.org/>

AWS CERTIFICATE MANAGER

AWS Certificate Manager

AWS Certificate Manager is a service that lets you easily provision, manage, and deploy Secure Sockets Layer/Transport Layer Security (SSL/TLS) certificates for use with AWS services. SSL/TLS certificates are used to secure network communications and establish the identity of websites over the Internet. AWS Certificate Manager removes the time-consuming manual process of purchasing, uploading, and renewing SSL/TLS certificates. With AWS Certificate Manager, you can quickly request a certificate, deploy it on AWS resources such as Elastic Load Balancers, Amazon CloudFront distributions, and APIs on API Gateway, and let AWS Certificate Manager handle certificate renewals. SSL/TLS certificates provisioned through AWS Certificate Manager are free. You pay only for the AWS resources you create to run your application.

**Manage Your AWS
Resources**

Sign in to the Console

<https://aws.amazon.com/certificate-manager/>

HOW DOES THIS STACK UP?

Server guarantees!

Payload not manipulated

Client guarantees?

Certificate management can be
painful

HOW DOES THIS STACK UP?

Server guarantees!

Payload not manipulated

Client guarantees?

Certificate management can be painful

Observation of data

Manipulation of data

Restricting access to endpoints

Impersonation of endpoints

HOW DOES THIS STACK UP?

Server guarantees!

Payload not manipulated

Client guarantees?

Certificate management can be painful



Observation of data

Manipulation of data

Restricting access to endpoints

Impersonation of endpoints

HOW DOES THIS STACK UP?

Server guarantees!

Payload not manipulated

Client guarantees?

Certificate management can be painful

 Observation of data

 Manipulation of data

Restricting access to endpoints

Impersonation of endpoints

HOW DOES THIS STACK UP?

Server guarantees!

Payload not manipulated

Client guarantees?

Certificate management can be painful

✓ Observation of data

✓ Manipulation of data

? Restricting access to endpoints

Impersonation of endpoints

HOW DOES THIS STACK UP?

Server guarantees!

Payload not manipulated

Client guarantees?

Certificate management can be painful

✓ Observation of data

✓ Manipulation of data

? Restricting access to endpoints

✓ Impersonation of endpoints

HTTPS EVERYWHERE!

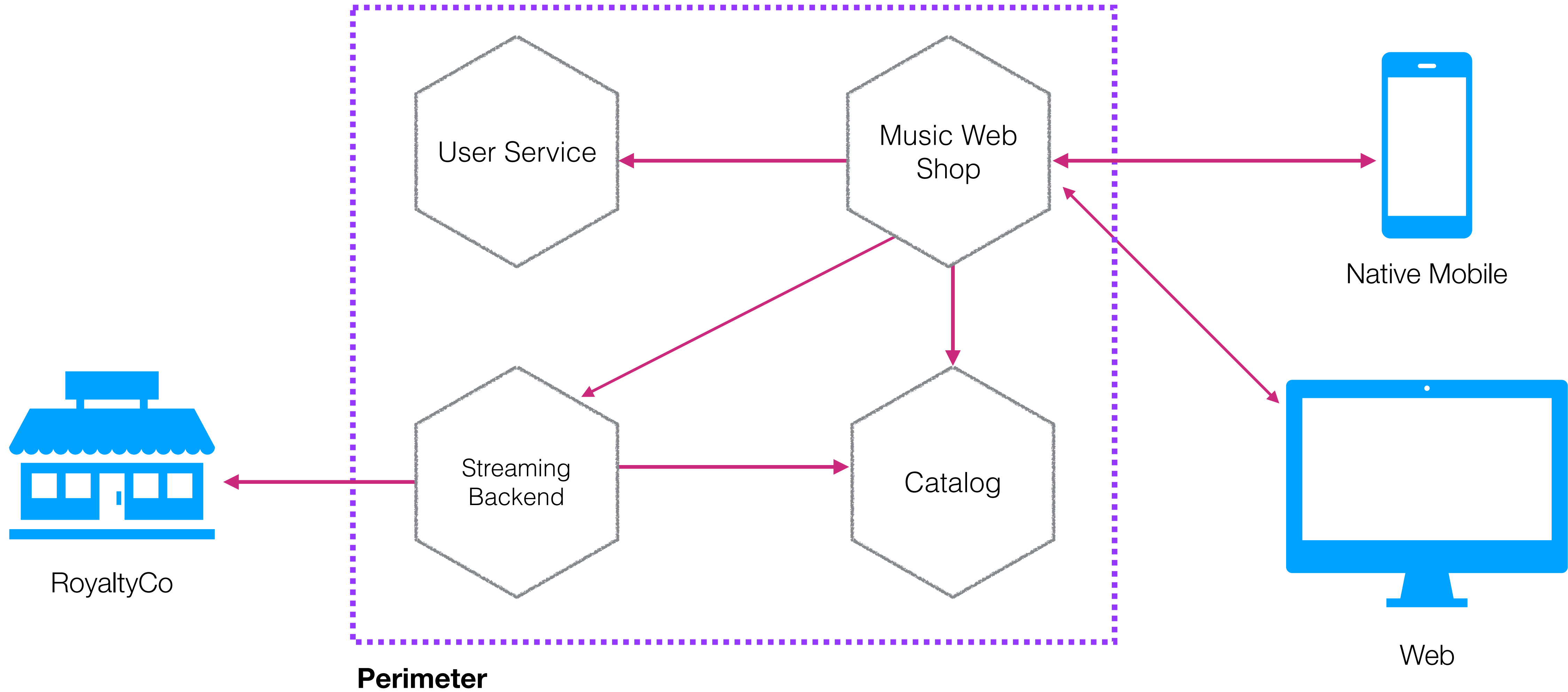

HTTPS EVERYWHERE!

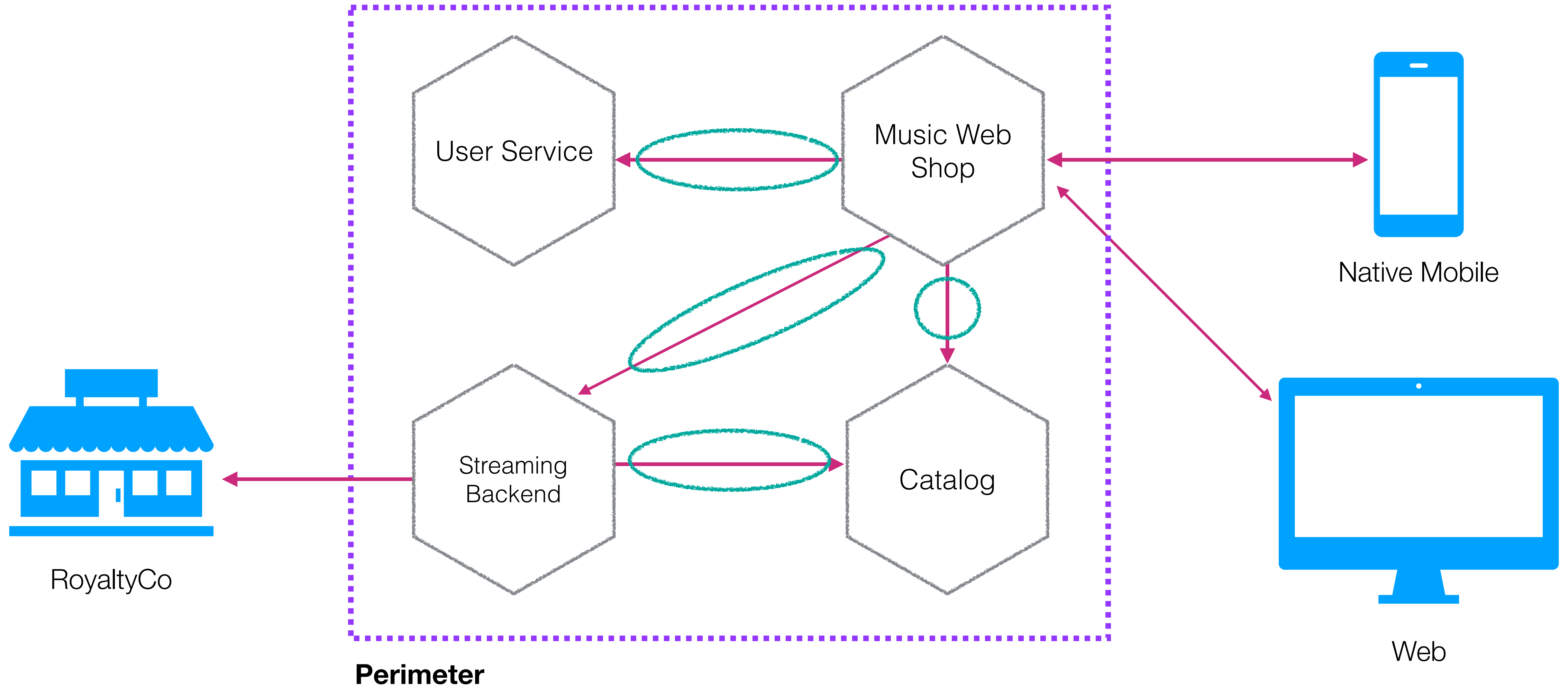

HTTPS EVERYWHERE!

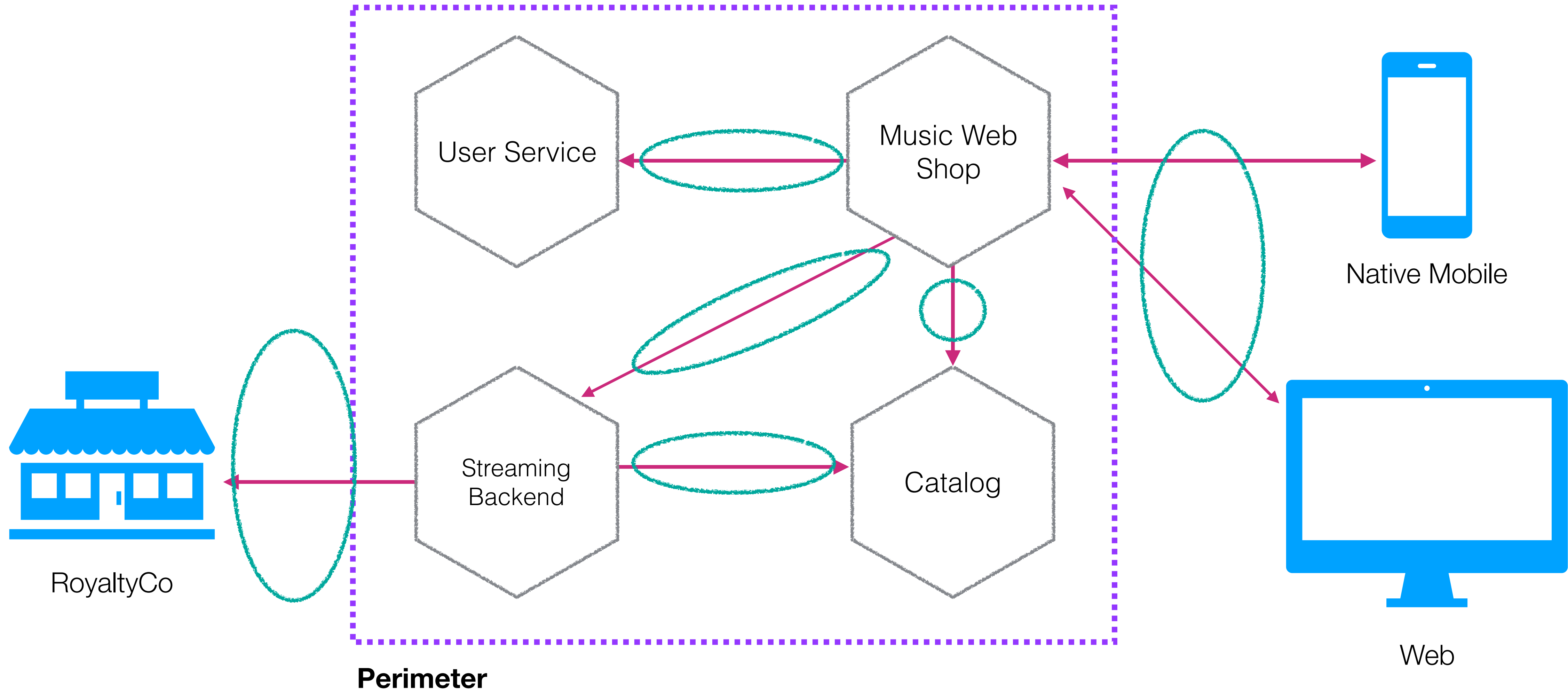

Mutual TLS

MUTUAL TLS

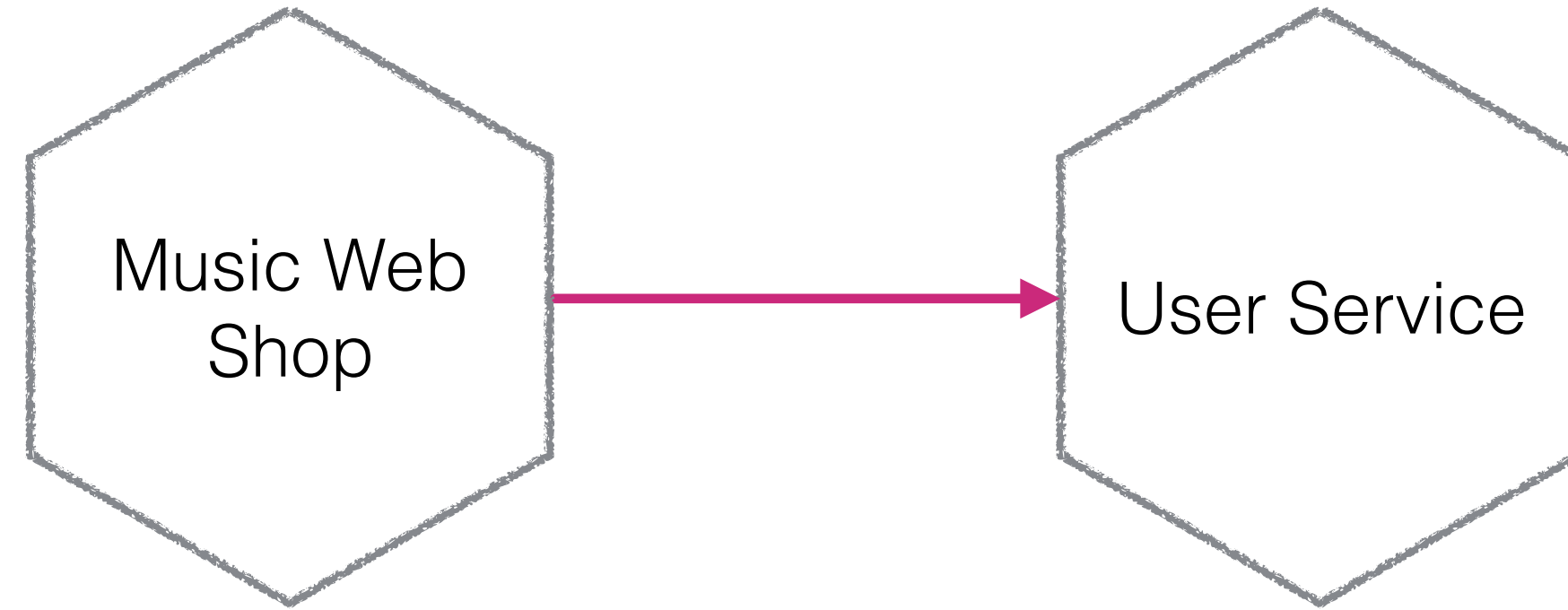

MUTUAL TLS

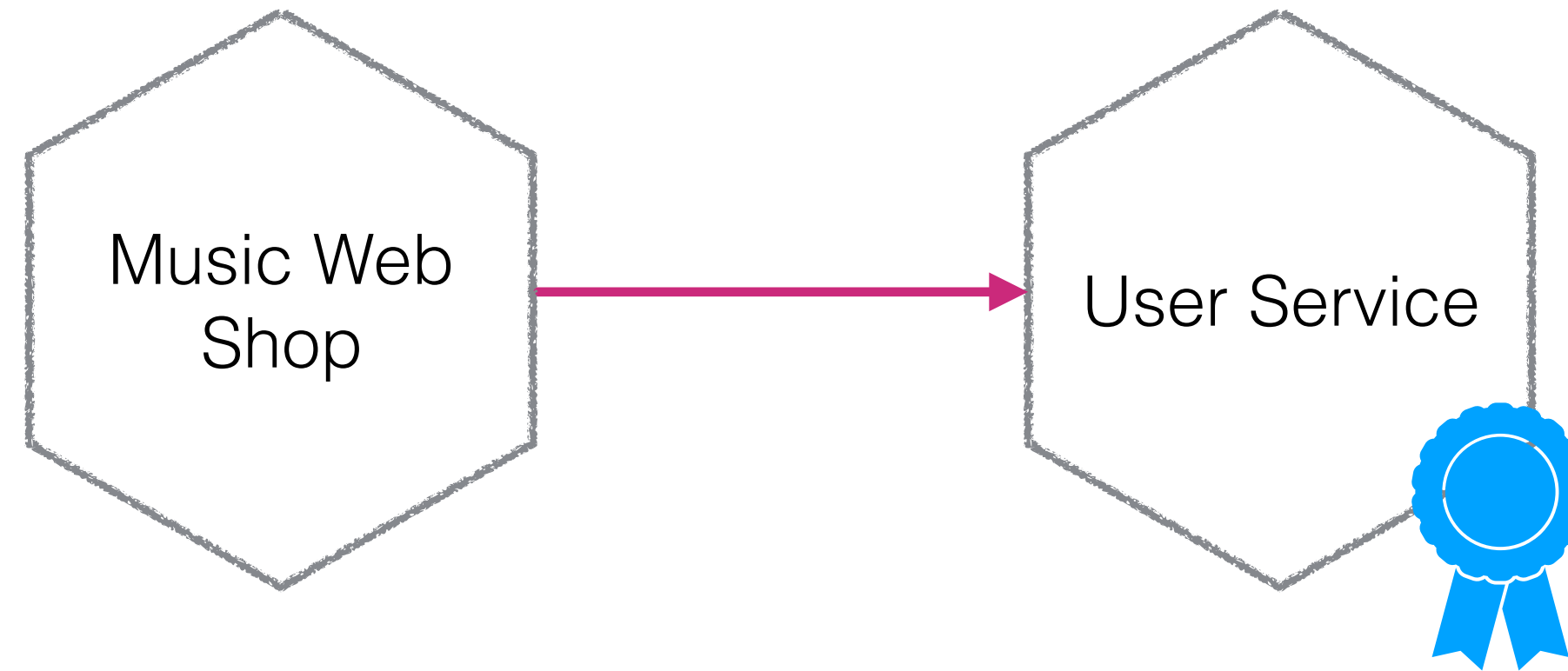

MUTUAL TLS

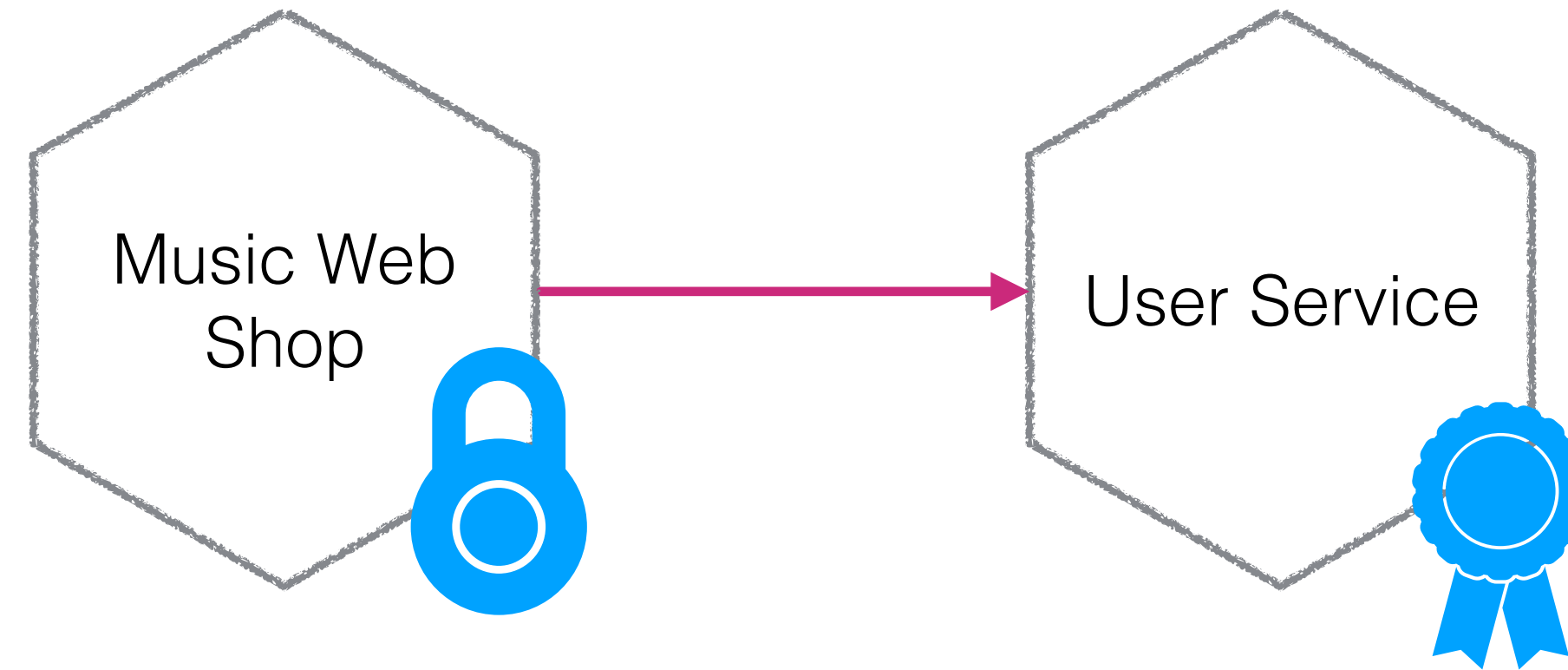

MUTUAL TLS

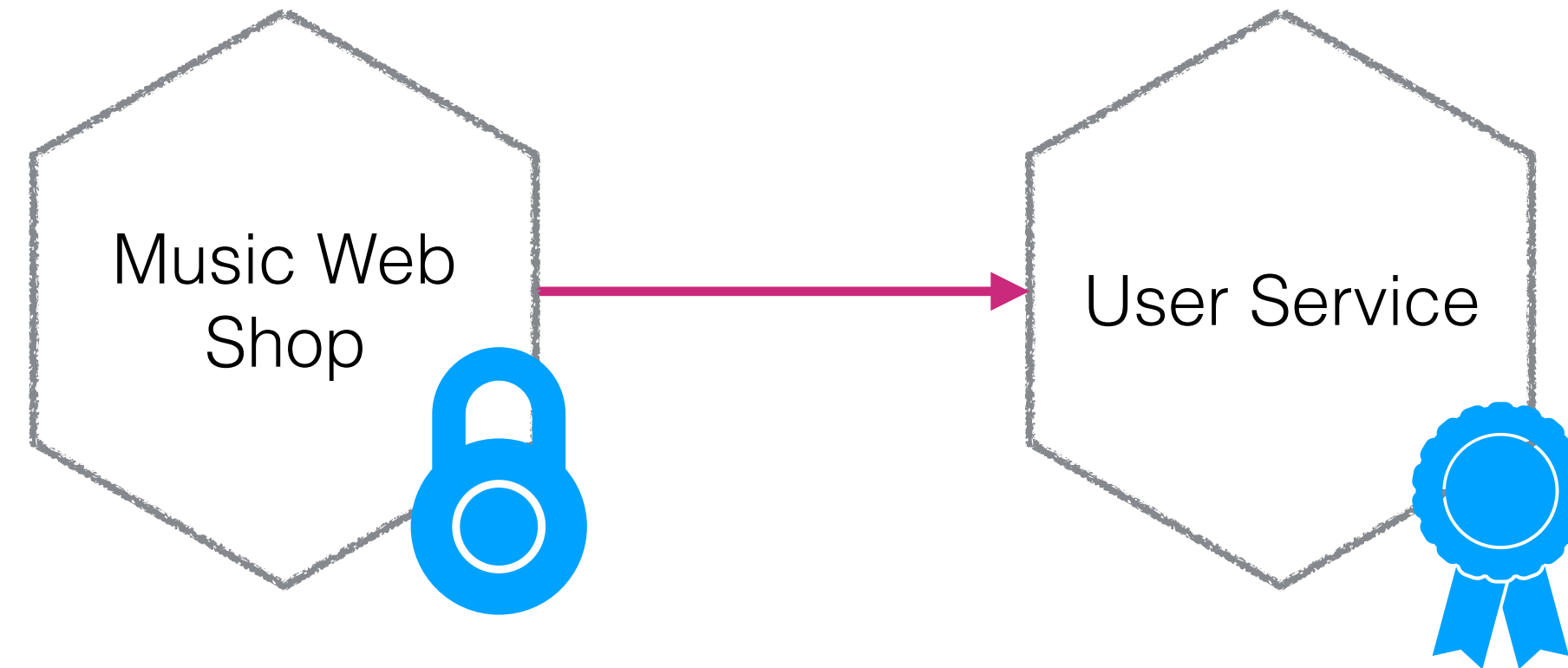

Client and server guarantees!

MUTUAL TLS

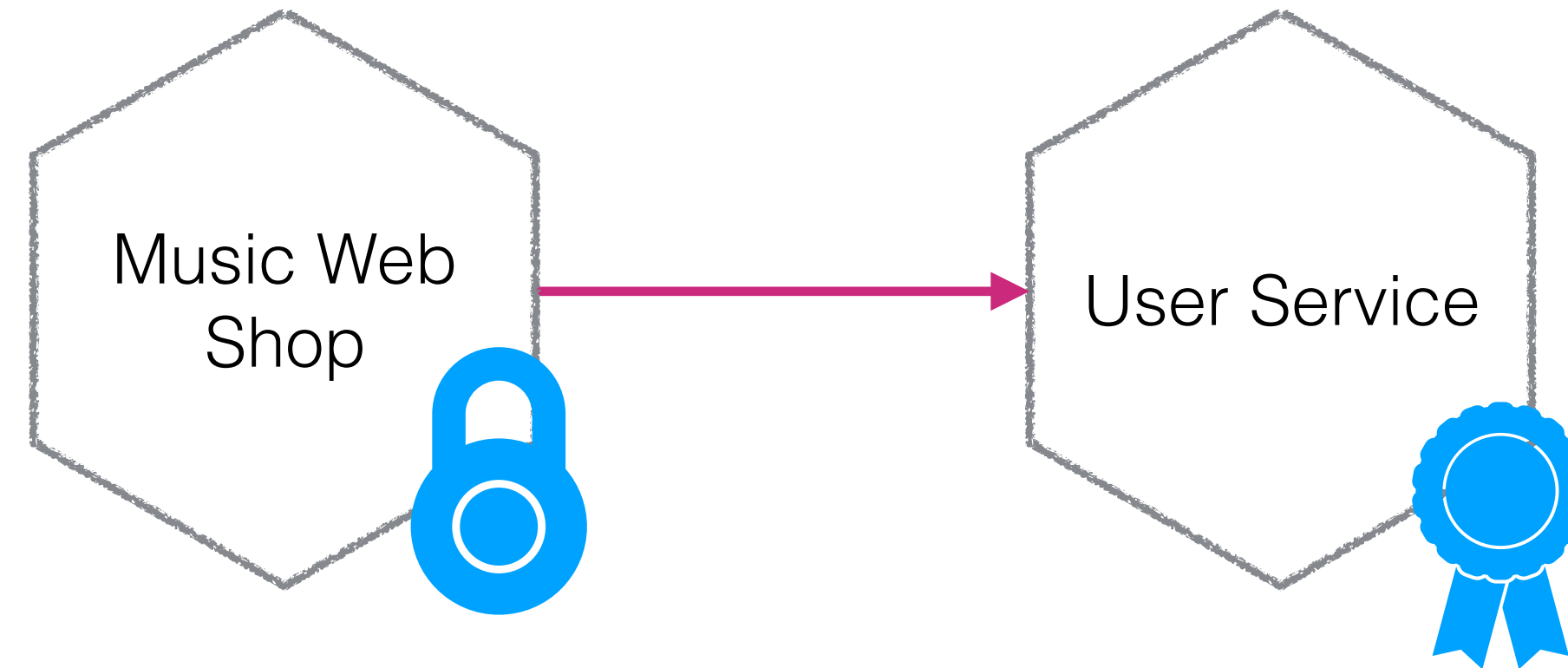

Client and server guarantees!

Certificate management is REALLY painful

AZURE - CLIENT-SIDE CERTIFICATE MANAGEMENT

How to secure back-end services using client certificate authentication in Azure API Management

📅 10/30/2017 • ⌚ 3 minutes to read • Contributors  all

In this article

[Prerequisites](#)

[Upload a client certificate](#)

[Delete a client certificate](#)

[Configure an API to use a client certificate for gateway authentication](#)

[Self-signed certificates](#)

[Next steps](#)

API Management provides the capability to secure access to the back-end service of an API using client certificates. This guide shows how to manage certificates in the API publisher portal, and how to configure an API to use a certificate to access its back-end service.

For information about managing certificates using the API Management REST API, see [Azure API Management REST API Certificate entity](#).

<https://docs.microsoft.com/en-us/azure/api-management/api-management-howto-mutual-certificates>

AWS - CLIENT-SIDE CERTIFICATE MANAGEMENT

[AWS Documentation](#) » [Amazon API Gateway](#) » [Developer Guide](#) » [Controlling Access to an API in API Gateway](#) » [Use Client-Side SSL Certificates for Authentication by the Backend](#)

Use Client-Side SSL Certificates for Authentication by the Backend

You can use API Gateway to generate an SSL certificate and use its public key in the backend to verify that HTTP requests to your backend system are from API Gateway. This allows your HTTP backend to control and accept only requests originating from Amazon API Gateway, even if the backend is publicly accessible.

Note

Some backend servers may not support SSL client authentication as API Gateway does and could return an SSL certificate error. For a list of incompatible backend servers, see [Known Issues](#).

The SSL certificates that are generated by API Gateway are self-signed and only the public key of a certificate is visible in the API Gateway console or through the APIs.

Topics

- [Generate a Client Certificate Using the API Gateway Console](#)
- [Configure an API to Use SSL Certificates](#)
- [Test Invoke](#)
- [Configure Backend to Authenticate API](#)

<https://docs.aws.amazon.com/apigateway/latest/developerguide/getting-started-client-side-ssl-authentication.html>

MUTUAL TLS

Observation of data

Manipulation of data

Restricting access to endpoints

Impersonation of endpoints

MUTUAL TLS

 Observation of data

Manipulation of data

Restricting access to endpoints

Impersonation of endpoints

MUTUAL TLS

✓ Observation of data

✓ Manipulation of data

Restricting access to endpoints

Impersonation of endpoints

MUTUAL TLS

- ✓ Observation of data
- ✓ Manipulation of data
- ✓ Restricting access to endpoints
- Impersonation of endpoints

MUTUAL TLS

- ✓ Observation of data
- ✓ Manipulation of data
- ✓ Restricting access to endpoints
- ✓ Impersonation of endpoints

MUTUAL TLS

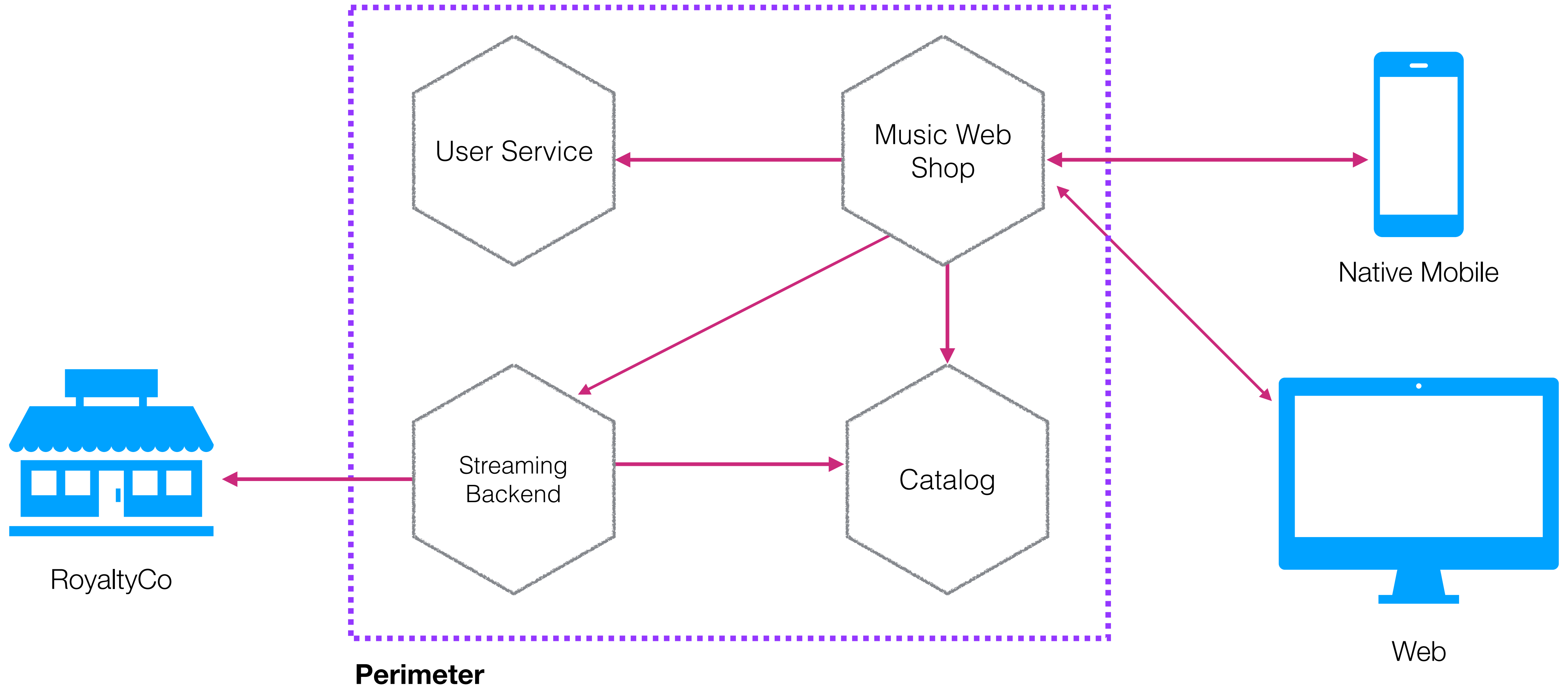

MUTUAL TLS

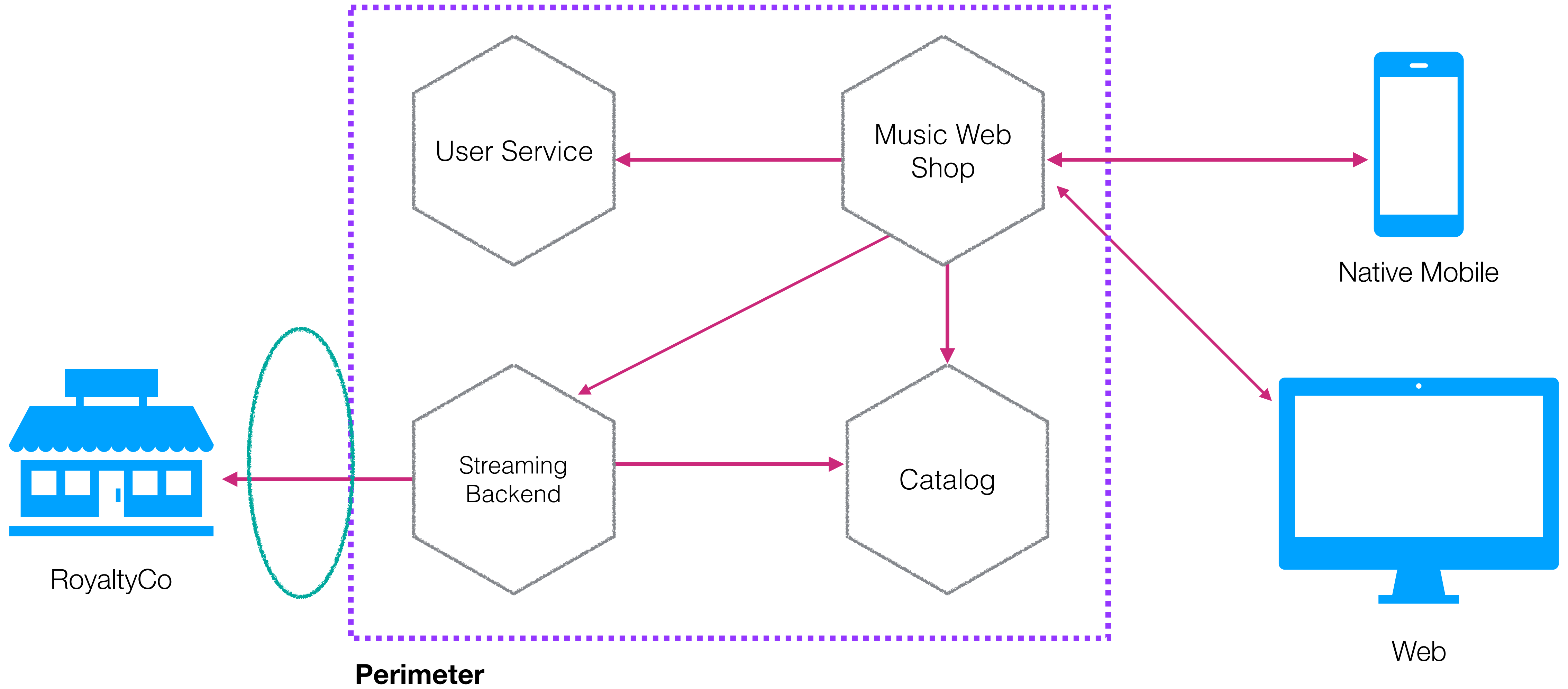

MUTUAL TLS

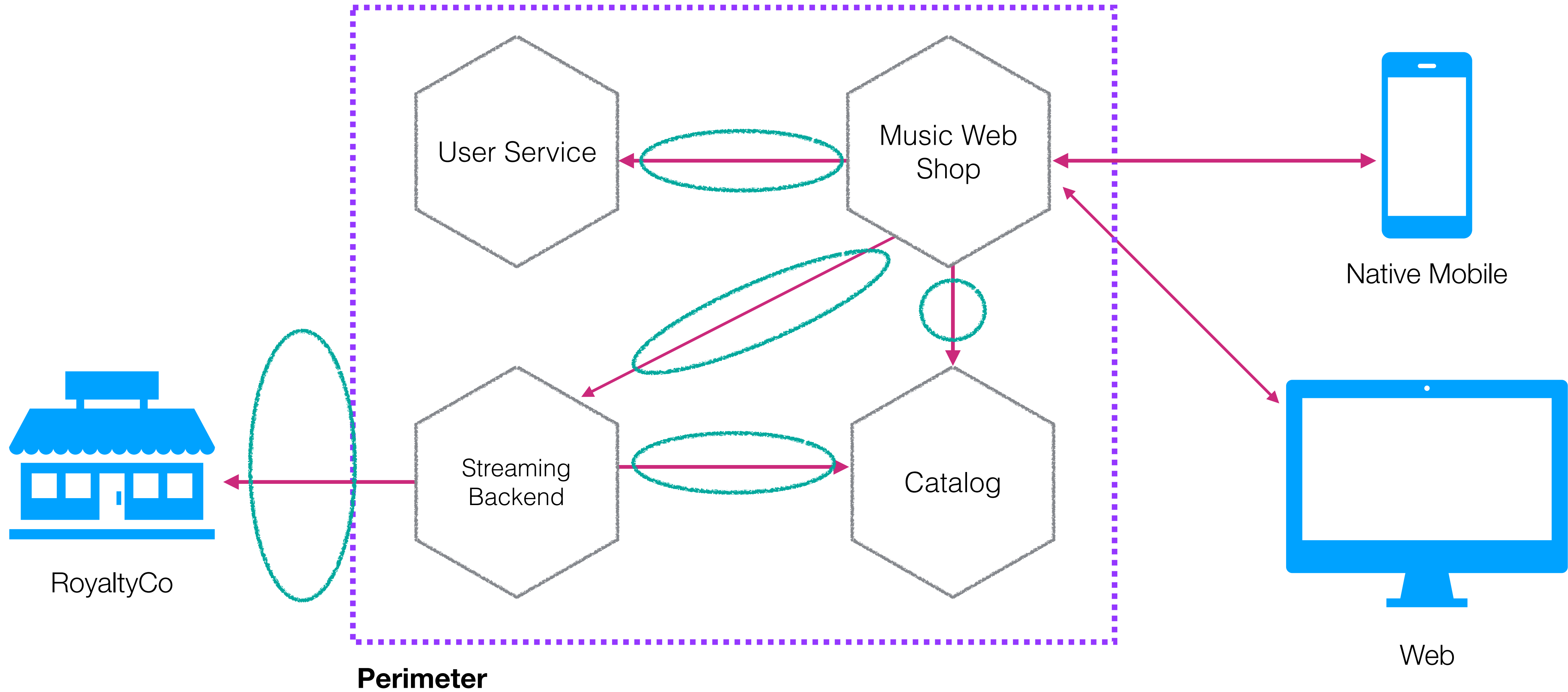

OTHER PROTOCOLS?



OTHER PROTOCOLS?



Synchronous, via HTTP, RPC or other

OTHER PROTOCOLS?

Async, via e.g. via message broker



Synchronous, via HTTP, RPC or other

OTHER PROTOCOLS?

Async, via e.g. via message broker

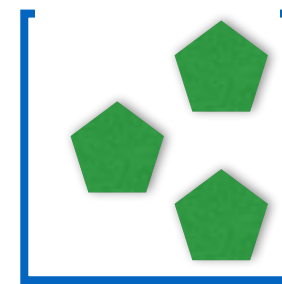

Synchronous, via HTTP, RPC or other

OTHER PROTOCOLS?

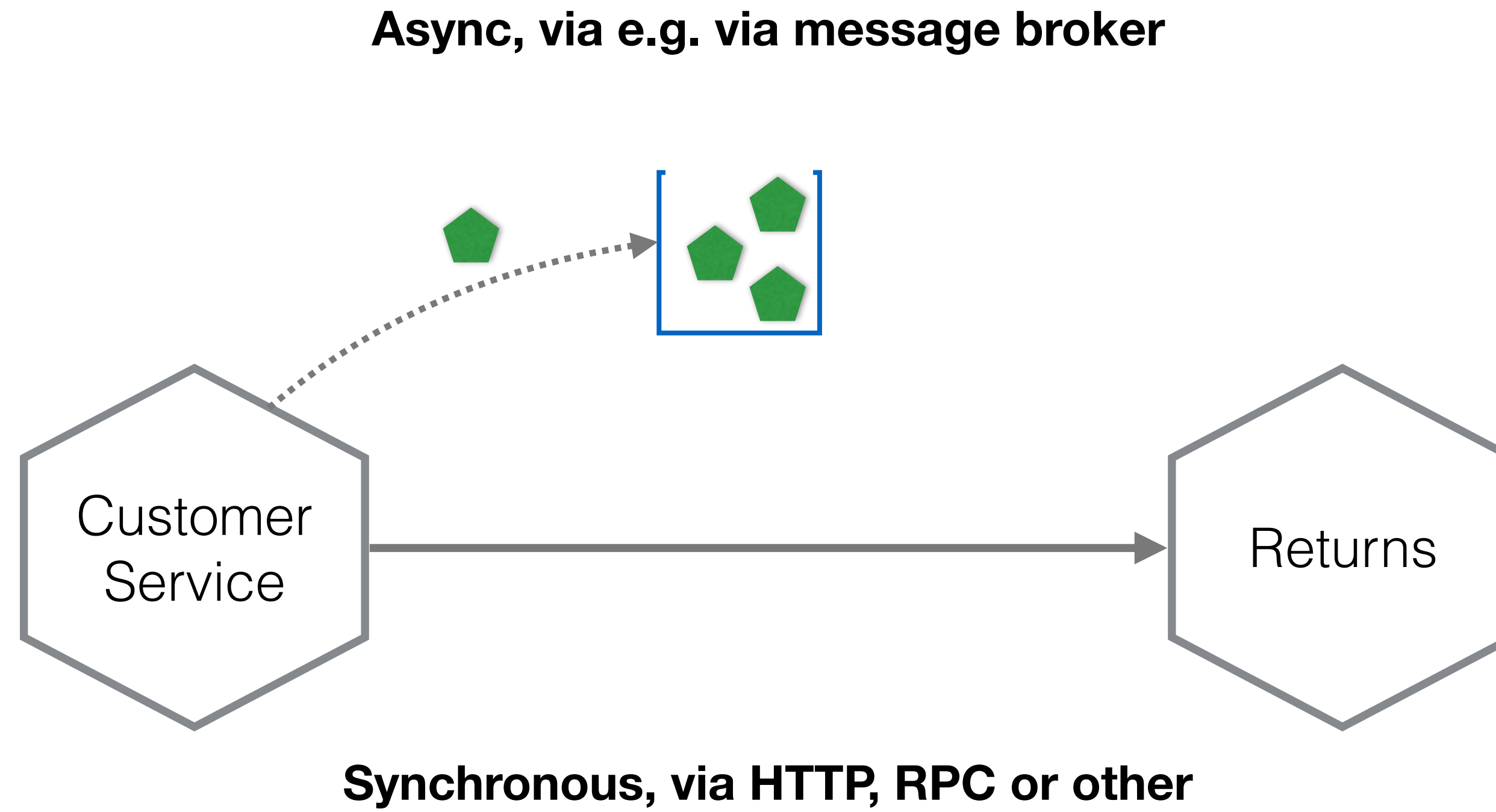

OTHER PROTOCOLS?

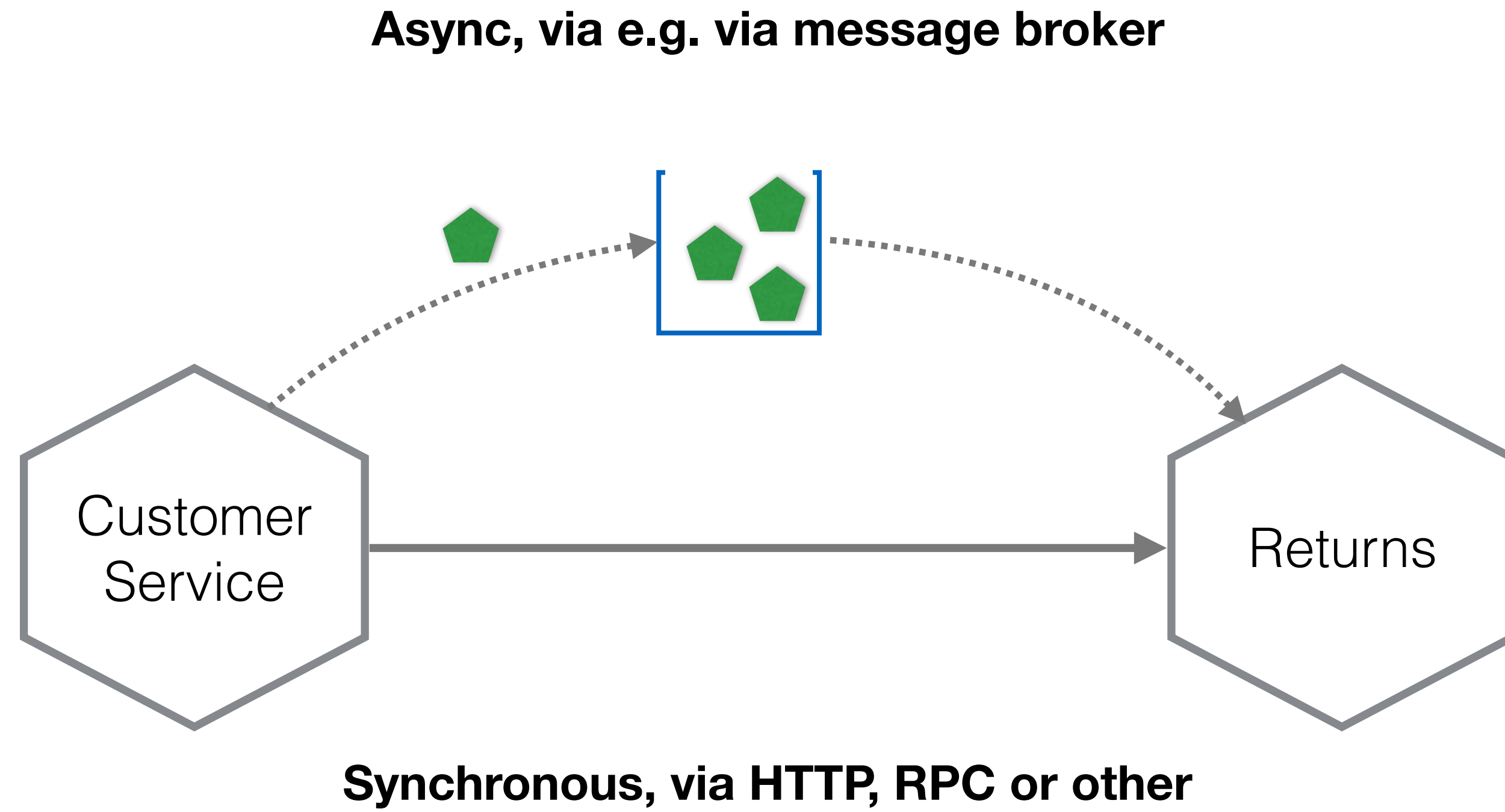

TLS Support

Intro

RabbitMQ has inbuilt support for TLS. This includes client connections and popular plugins, where applicable, such as [Federation links](#). It is also possible to use TLS to [encrypt inter-node connections in clusters](#).

This guide covers various topics related to TLS in RabbitMQ:

- Enabling TLS listeners in RabbitMQ

- How to generate self-signed certificates for development and QA environments

- TLS configuration in Java and .NET clients

- Known vulnerabilities and their migration

- TLS version and cipher suite configuration

- Certificate chain validation depth

- Tools that can be used to evaluate a TLS setup

and more. It is not, however, a primer on TLS, encryption, [Public Key Infrastructure](#) and related topics, so the concepts are covered very briefly. A number of beginner-oriented primers are available elsewhere on the Web: [one](#), [two](#), [three](#), [four](#).

TLS Support

Intro

RabbitMQ has inbuilt support for TLS. This includes client connections and popular plugins, where applicable, such as [Federation links](#). It is also possible to use TLS to [encrypt inter-node connections in clusters](#).

This guide covers various topics related to TLS in RabbitMQ:

Enabling TLS listeners in RabbitMQ

How to generate self-signed certificates for development and QA environments

TLS configuration in Java and .NET clients

Known vulnerabilities and their migration

TLS version and cipher suite configuration

Certificate chain validation depth

Tools th

and more

topics, s

available

Erlang/OTP Requirements for TLS Support

In order to support TLS connections, RabbitMQ needs TLS and crypto-related modules to be available in the Erlang/OTP installation. The recommended Erlang/OTP version to use with TLS is the most recent [supported Erlang release](#). Earlier versions, even if they are supported, may work for most certificates but have known limitations (see below).

TLS Support

Intro

RabbitMQ has inbuilt support for TLS. This includes client connections and popular plugins, where applicable, such as [Federation links](#). It is also possible to use TLS to [encrypt inter-node connections in clusters](#).

This guide covers various topics related to TLS in RabbitMQ:

Enabling TLS listeners in RabbitMQ

How to generate self-signed certificates for development and QA environments

TLS configuration in Java and .NET clients

Known vulnerabilities and their migration

TLS version and cipher suite configuration

Certificate chain validation depth

Tools th

and more

topics, se

available

Erlang/OTP Requirements for TLS Support

In order to support TLS connections, RabbitMQ needs TLS and crypto-related modules to be available in the Erlang/OTP installation. The recommended Erlang/OTP version to use with TLS is the most recent [supported Erlang release](#). Earlier versions, even if they are supported, may work for most certificates but have known limitations (see below).

Access Control (Authentication, Authorisation) in RabbitMQ

This document describes authentication and authorisation machinery that implements access control. Authentication backends should not be confused with [authentication mechanisms](#) in AMQP 0-9-1.

A separate guide covers multiple topics around [passwords](#). It is only applicable to the internal authentication backend.

Terminology and Definitions

Authentication and authorisation are often confused or used interchangeably. That's wrong and in RabbitMQ, the two are separated. For the sake of simplicity, we'll define authentication as "identifying who the user is" and authorisation as "determining what the user is and isn't allowed to do."

Default Virtual Host and User

When the server first starts running, and detects that its database is uninitialised or has been deleted, it initialises a fresh database with the following resources:

TLS, Kerberos, SASL, and Authorizer in Apache Kafka 0.9 – Enabling New Encryption, Authorization, and Authentication Features

[Apache Kafka](#) is frequently used to store critical data making it one of the most important components of a company's data infrastructure. Our goal is to make it possible to run Kafka as a central platform for streaming data, supporting anything from a single app to a whole company. Multi-tenancy is an essential requirement in achieving this vision and, in turn, security features are crucial for multi-tenancy.

Previous to 0.9, Kafka had no built-in security features. One could lock down access at the network level but this is not viable for a big shared multi-tenant cluster being used across a large company. Consequently securing Kafka has been one of the most requested features. Security is of particular importance in today's world where cyber-attacks are a common occurrence and the threat of data breaches is a reality for businesses of all sizes, and at all levels from individual users to whole government entities.

Four key security features were added in [Apache Kafka 0.9](#), which is included in the [Confluent Platform 2.0](#):

TLS, Kerberos, SASL, and Authorizer in Apache Kafka 0.9 – Enabling New Encryption, Authorization, and Authentication Features

Apache Kafka is frequently used to store a company's data infrastructure. Our goal is supporting anything from a single app to this vision and, in turn, security features a

Previous to 0.9, Kafka had no built-in security not viable for a big shared multi-tenant cloud has been one of the most requested features attacks are a common occurrence and the levels from individual users to whole government entities.

Four key security features were added in [Apache Kafka 0.9](#), which is included in the [Confluent Platform 2.0](#):

1. Administrators can require client authentication using either Kerberos or Transport Layer Security (TLS) client certificates, so that Kafka brokers know who is making each request
2. A Unix-like permissions system can be used to control which users can access which data.
3. Network communication can be encrypted, allowing messages to be securely sent across untrusted networks.
4. Administrators can require authentication for communication between Kafka brokers and ZooKeeper.

Four key security features were added in [Apache Kafka 0.9](#), which is included in the [Confluent Platform 2.0](#):

TRANSPORT AUTHENTICATION

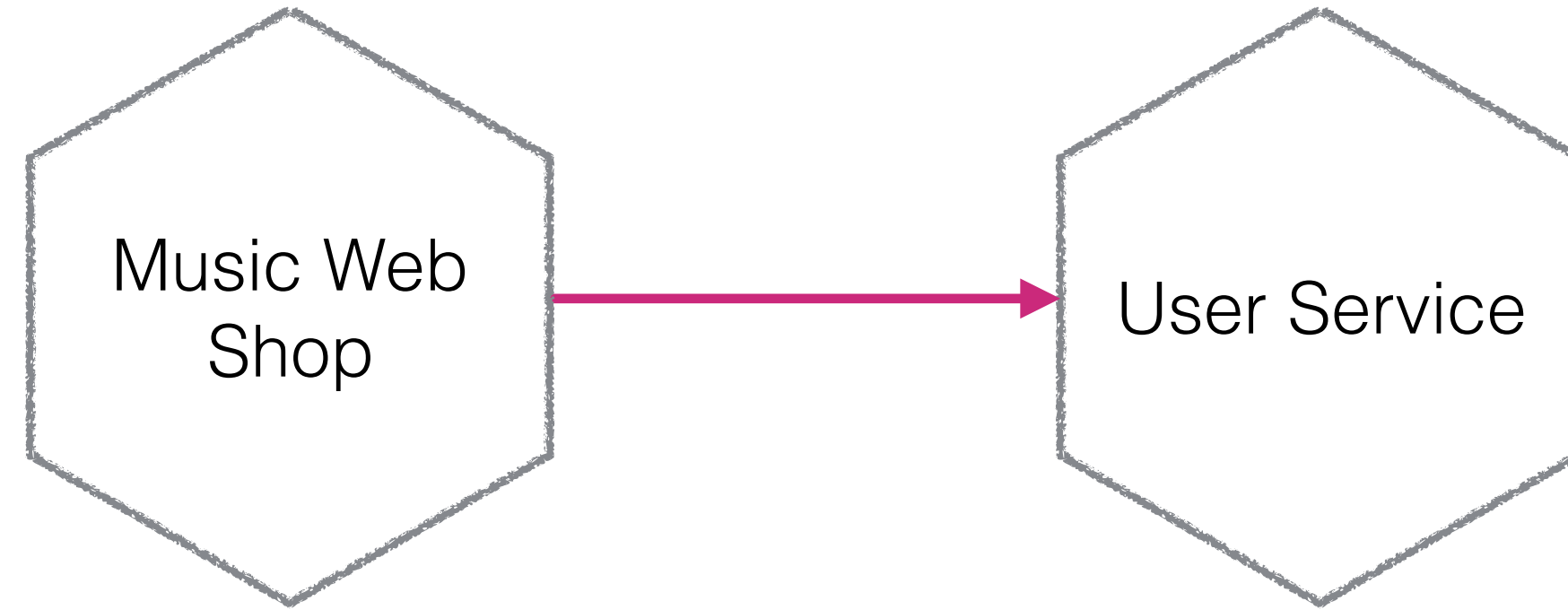

TRANSPORT AUTHENTICATION

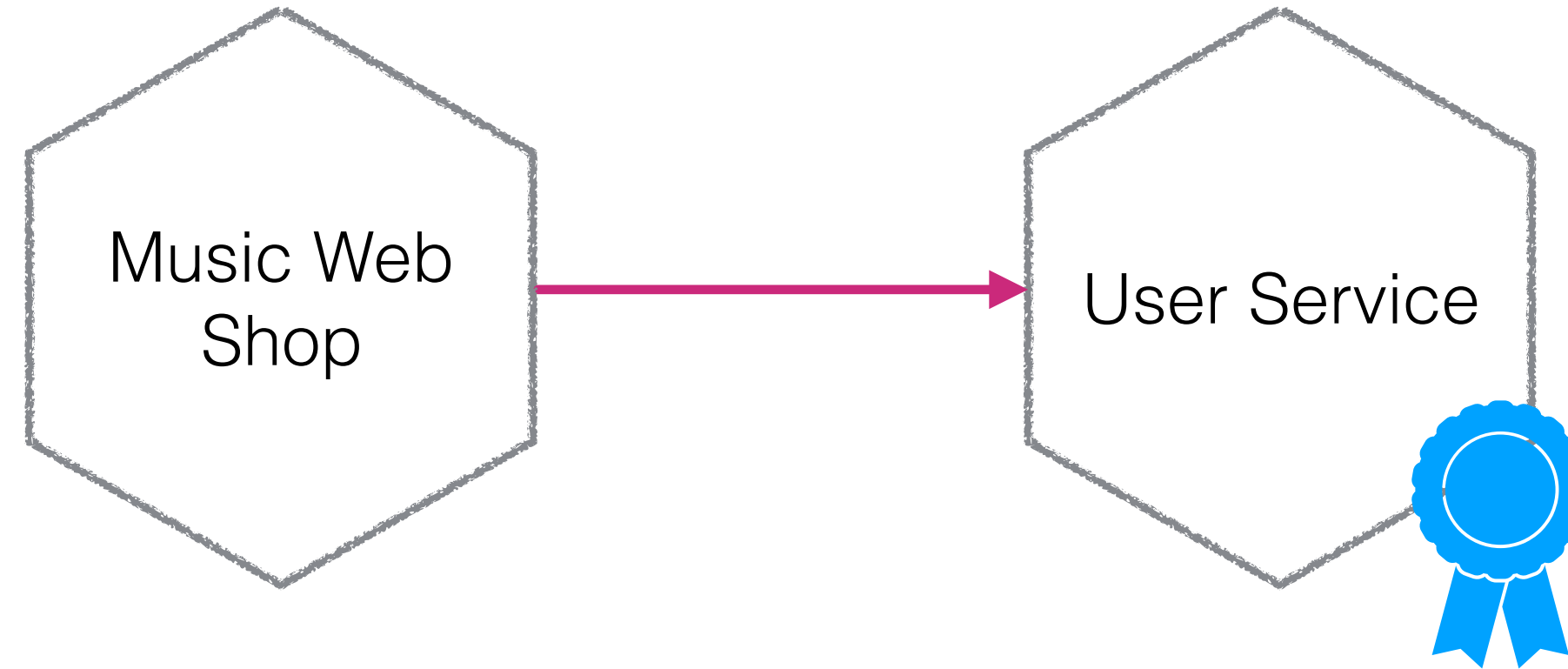

TRANSPORT AUTHENTICATION

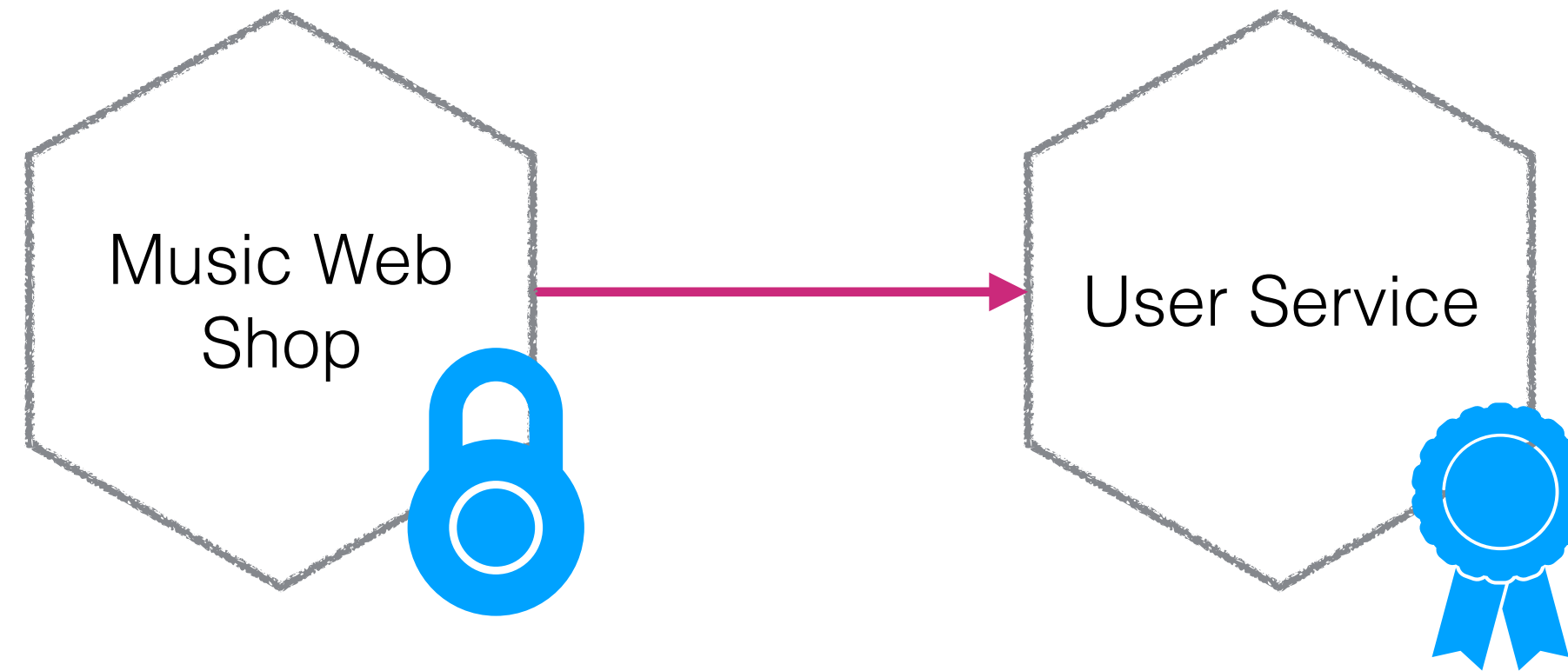

TRANSPORT AUTHENTICATION

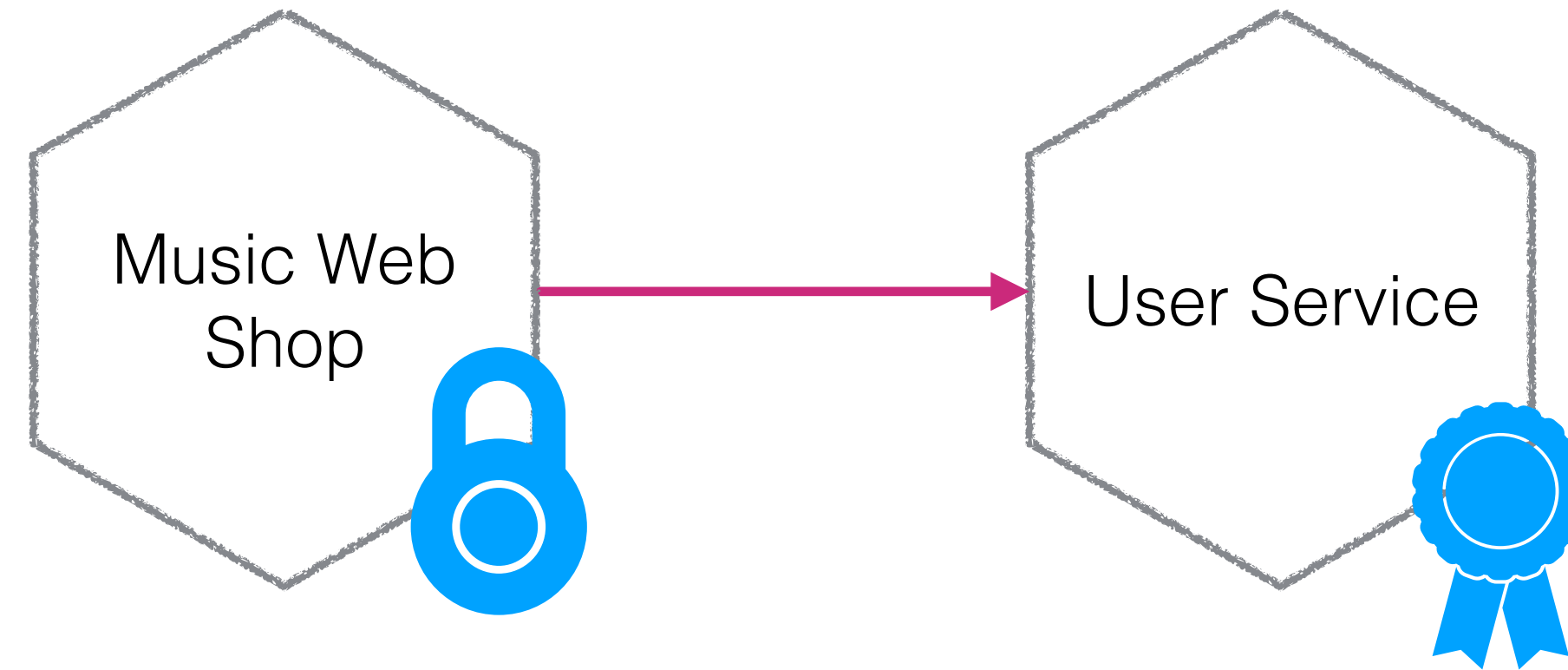

Server-side identity

TRANSPORT AUTHENTICATION

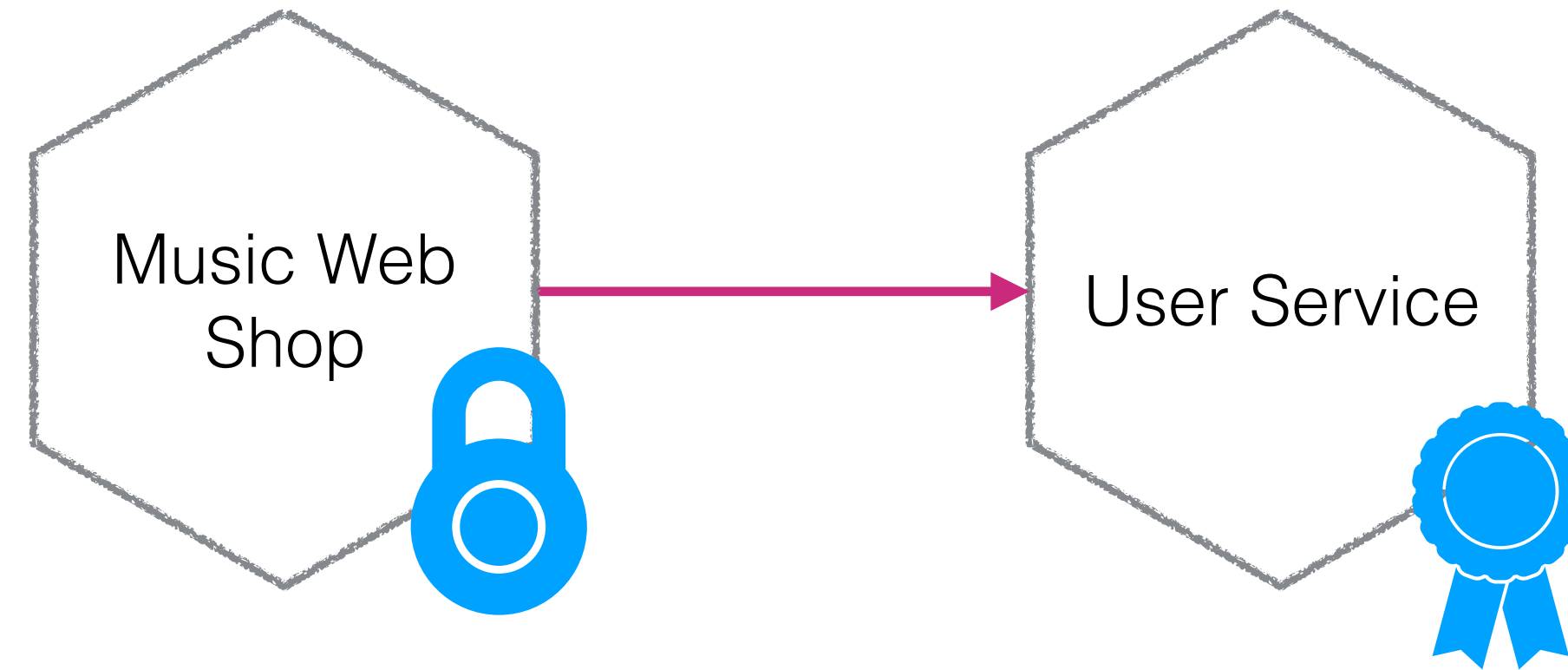

Client-side identity

Server-side identity

TRANSPORT AUTHENTICATION

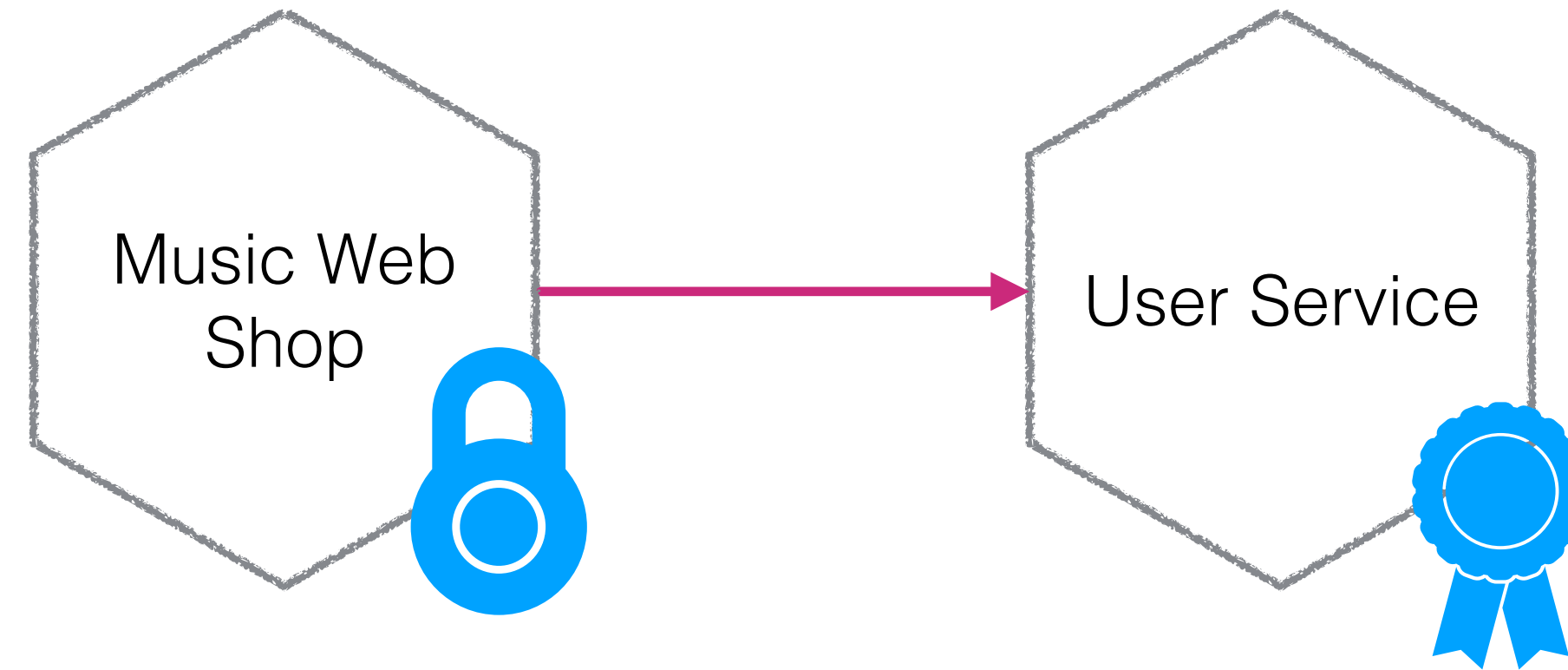

Client-side identity

Server-side identity

= service-to-service authentication



USER AUTHENTICATION - PROXY-BASED

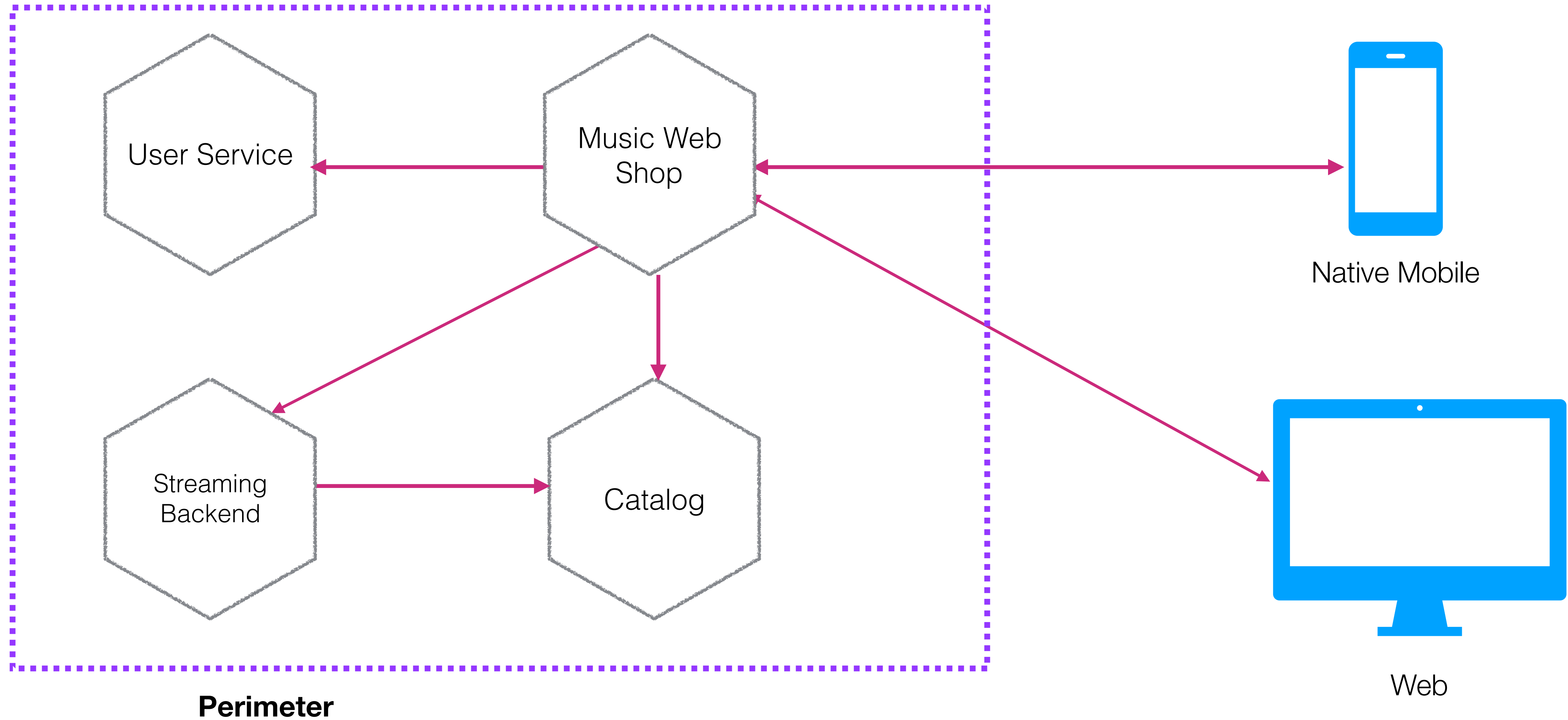

USER AUTHENTICATION - PROXY-BASED

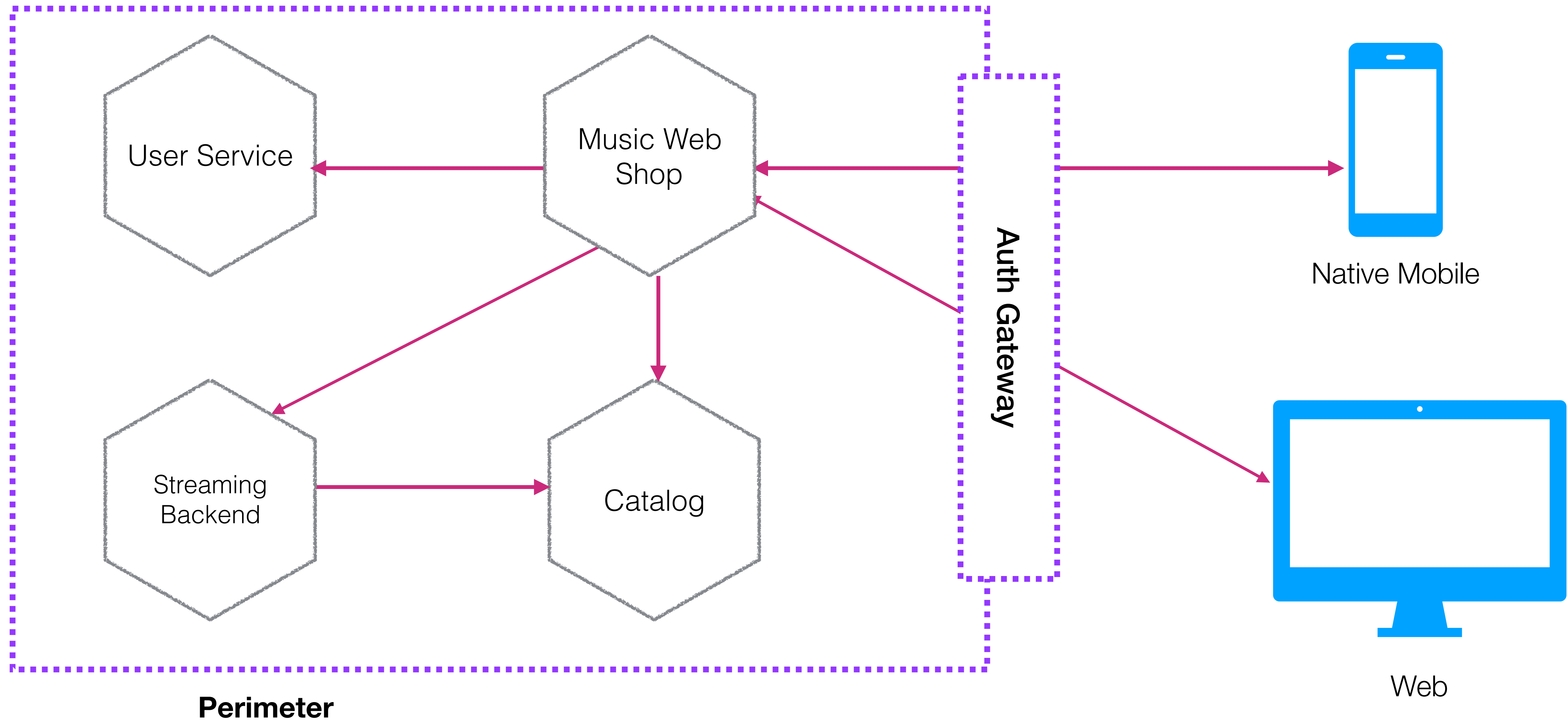

USER AUTHENTICATION - PROXY-BASED

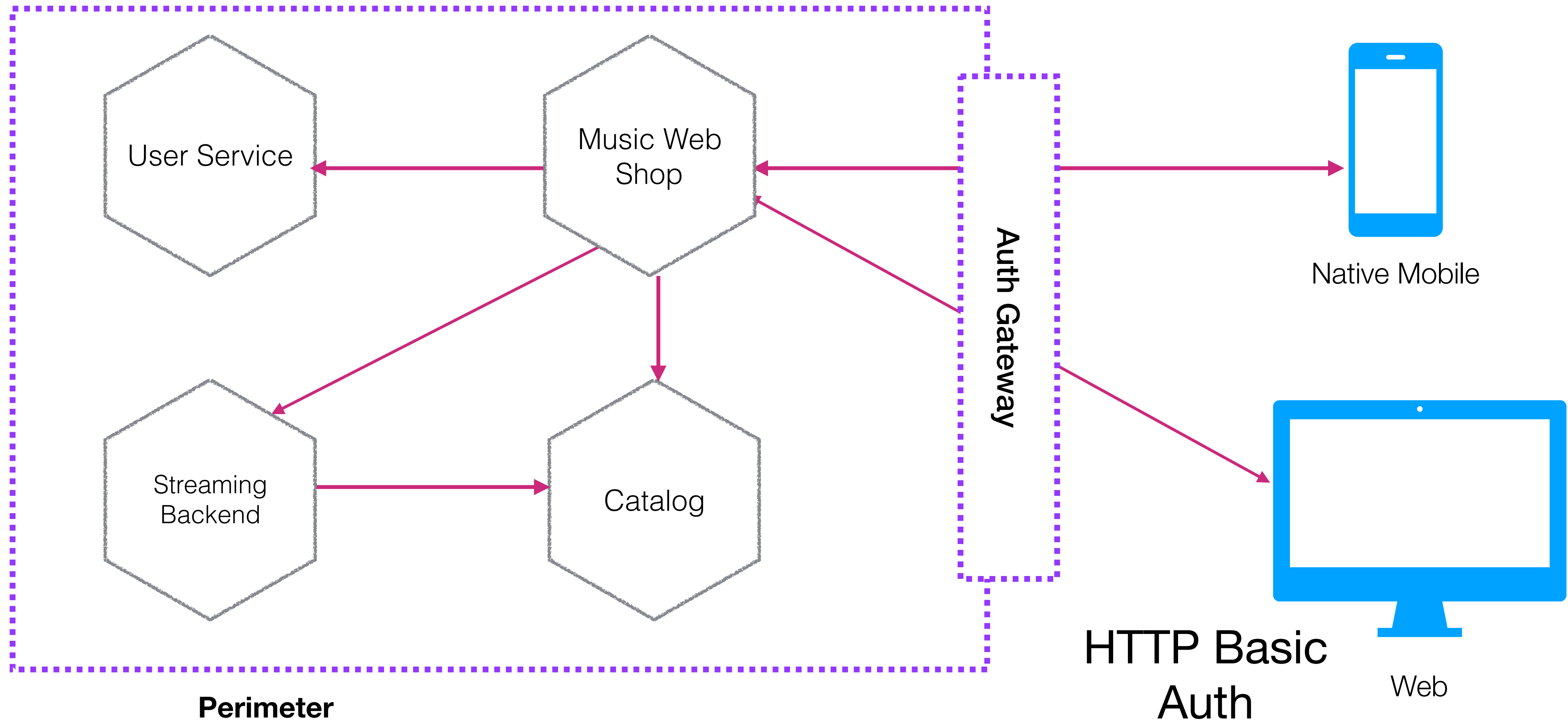

USER AUTHENTICATION - PROXY-BASED

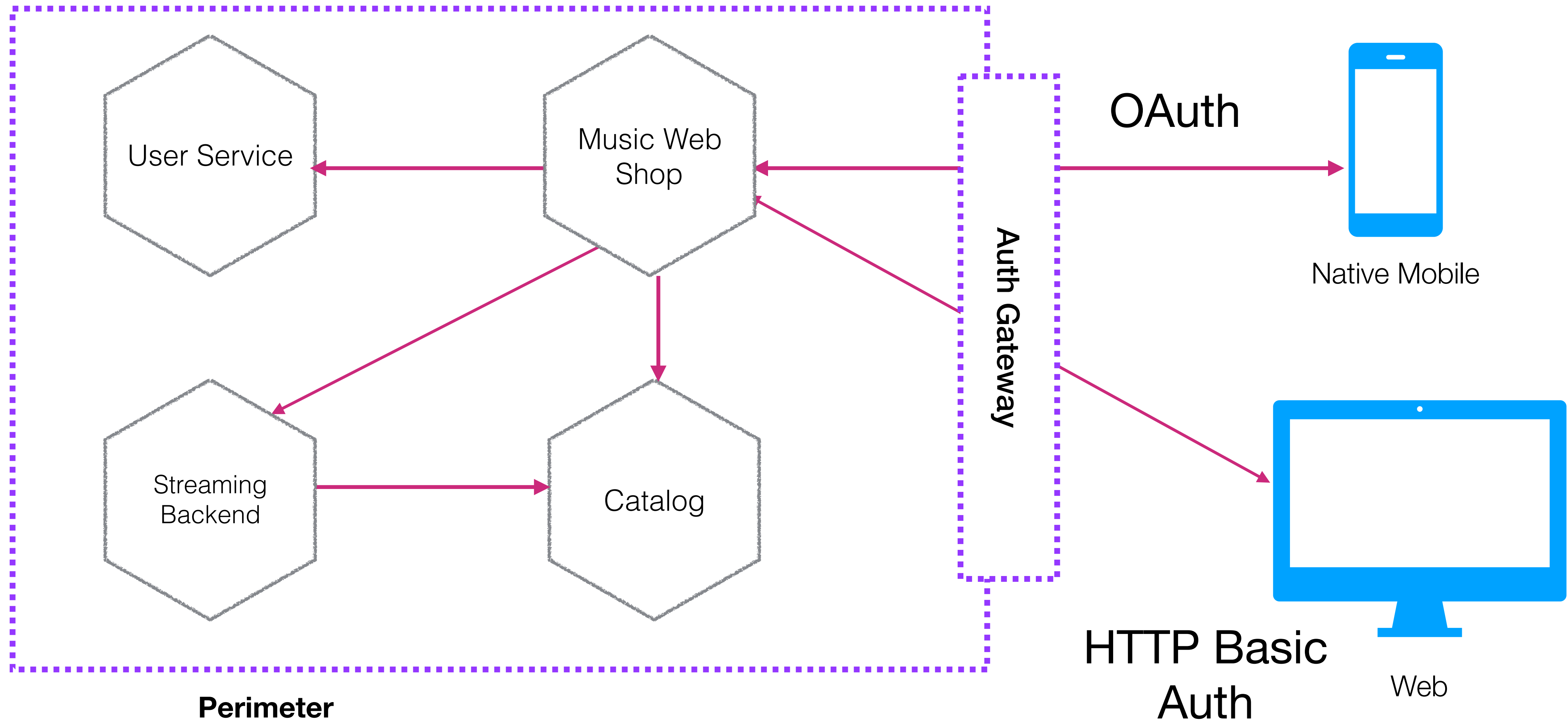

USER AUTHENTICATION - PROXY-BASED

Only authenticated

users

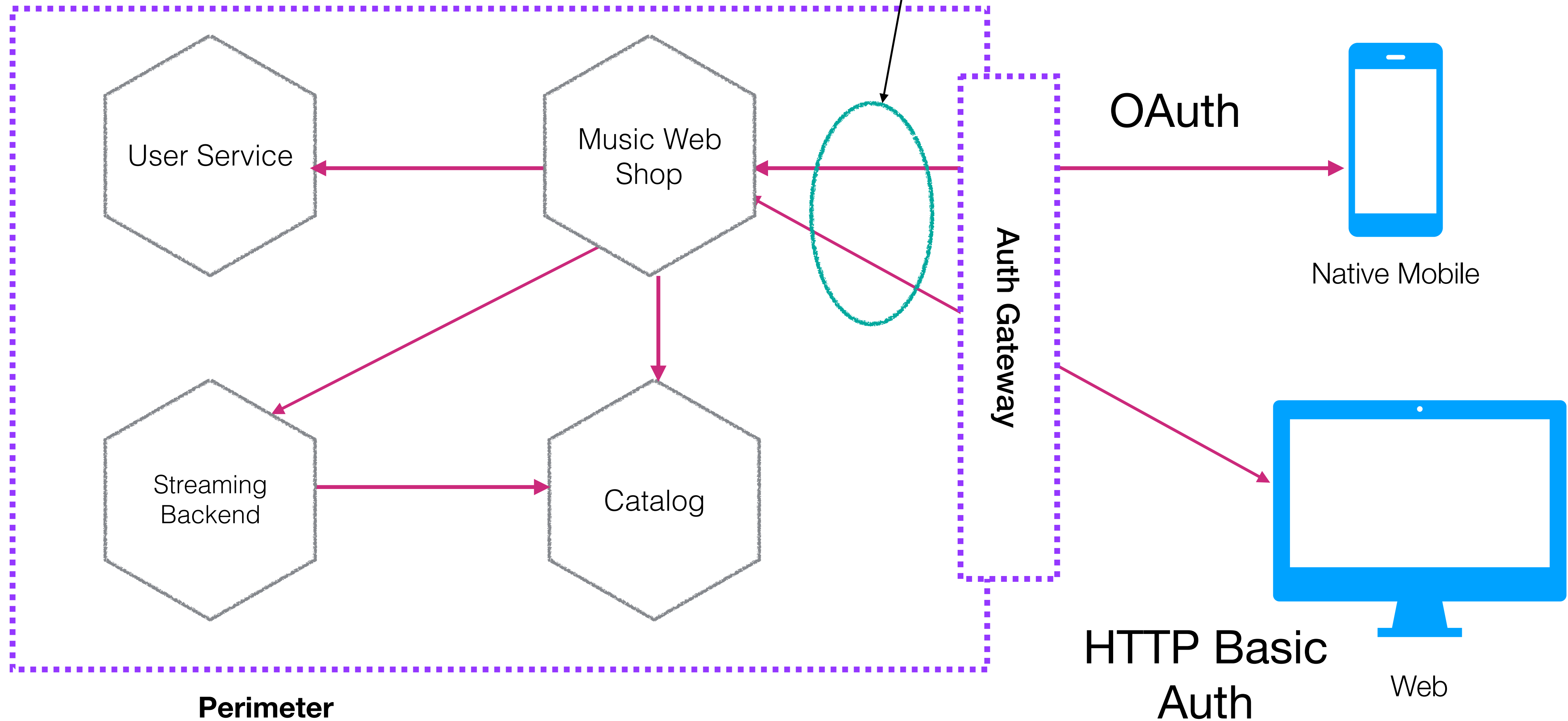

USER AUTHENTICATION - HANDLED IN SERVICE

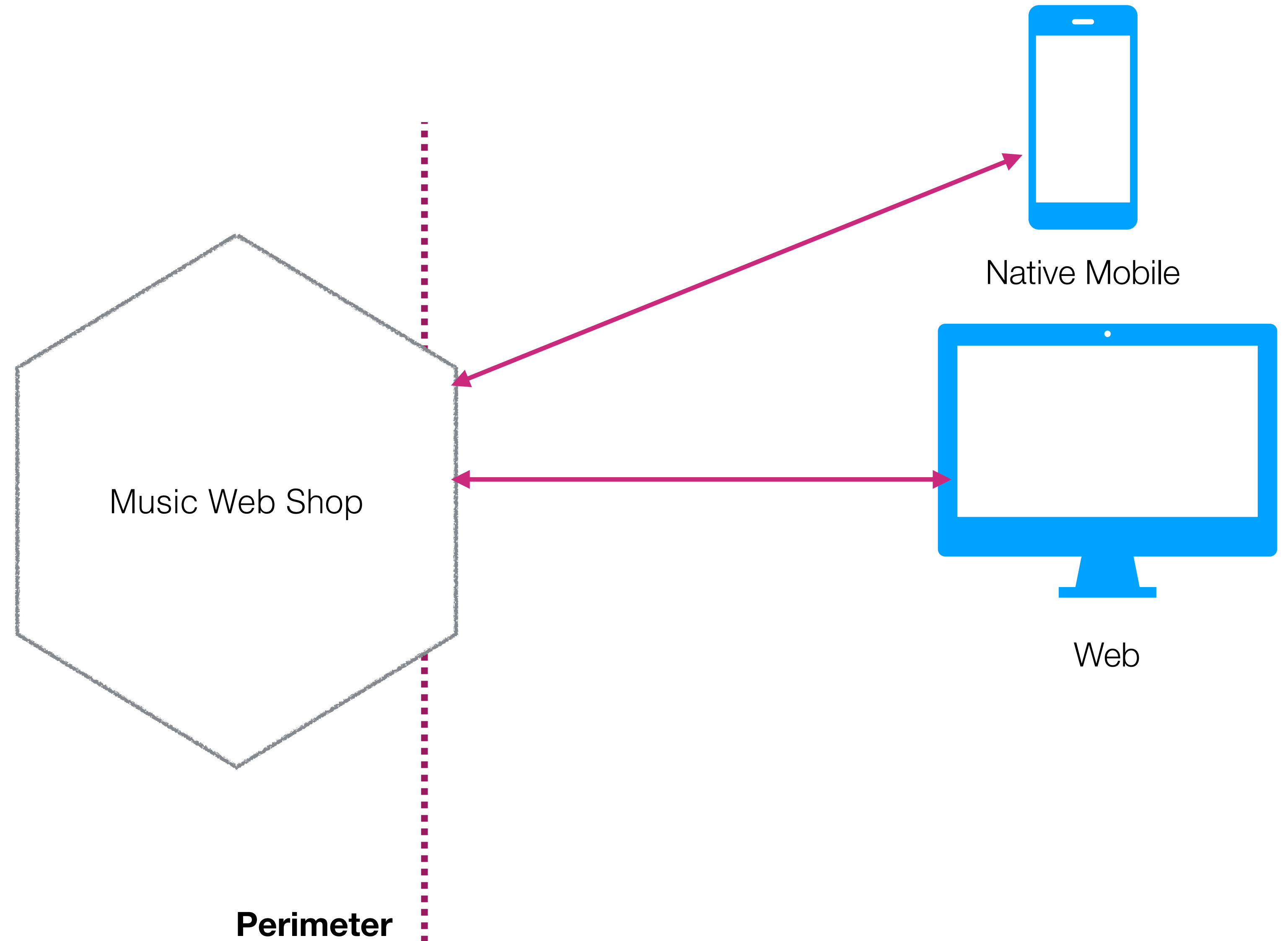

USER AUTHENTICATION - HANDLED IN SERVICE

Can reduce latency

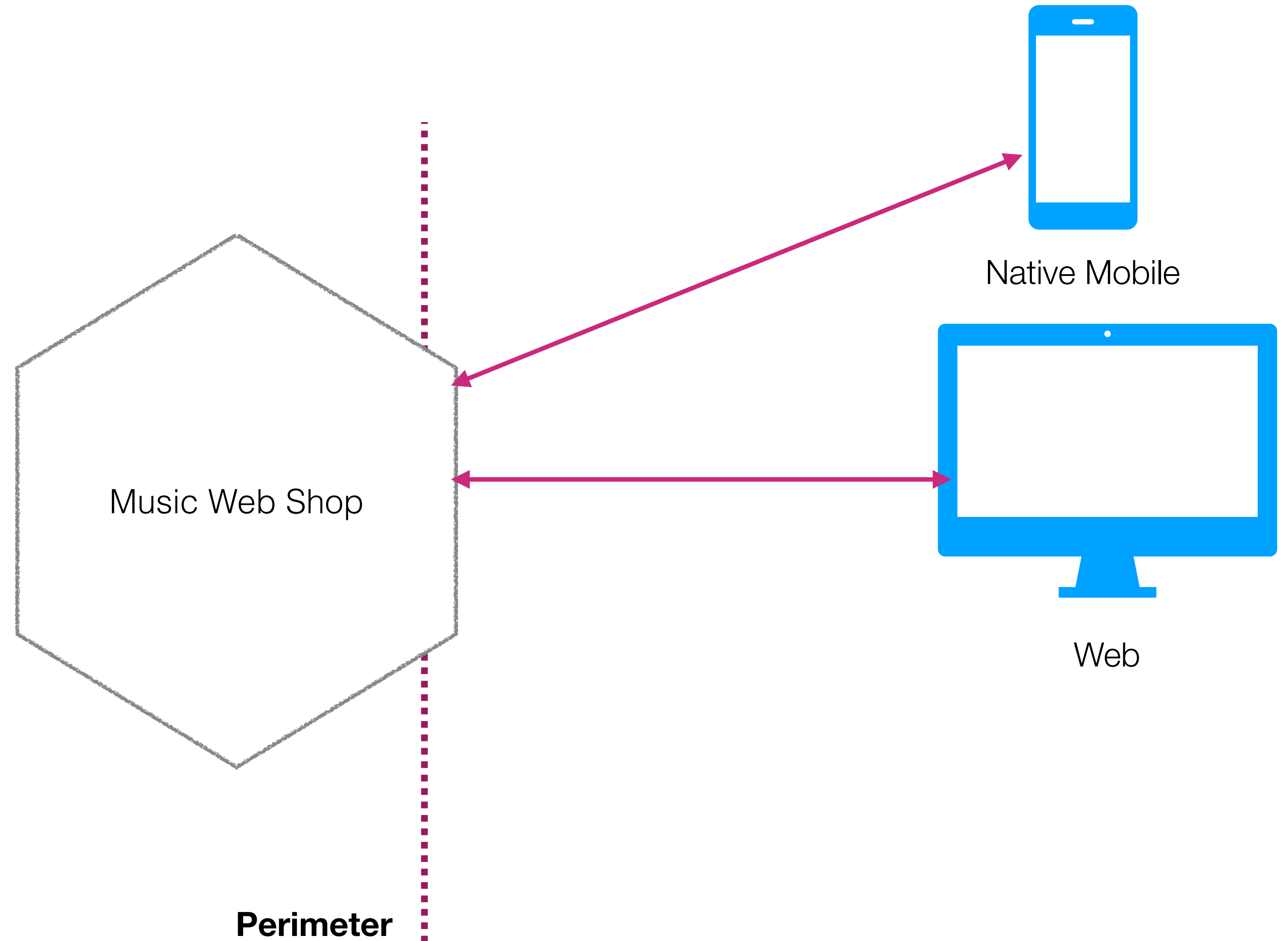

USER AUTHENTICATION - HANDLED IN SERVICE

Can reduce latency

Service potentially exposed to public internet

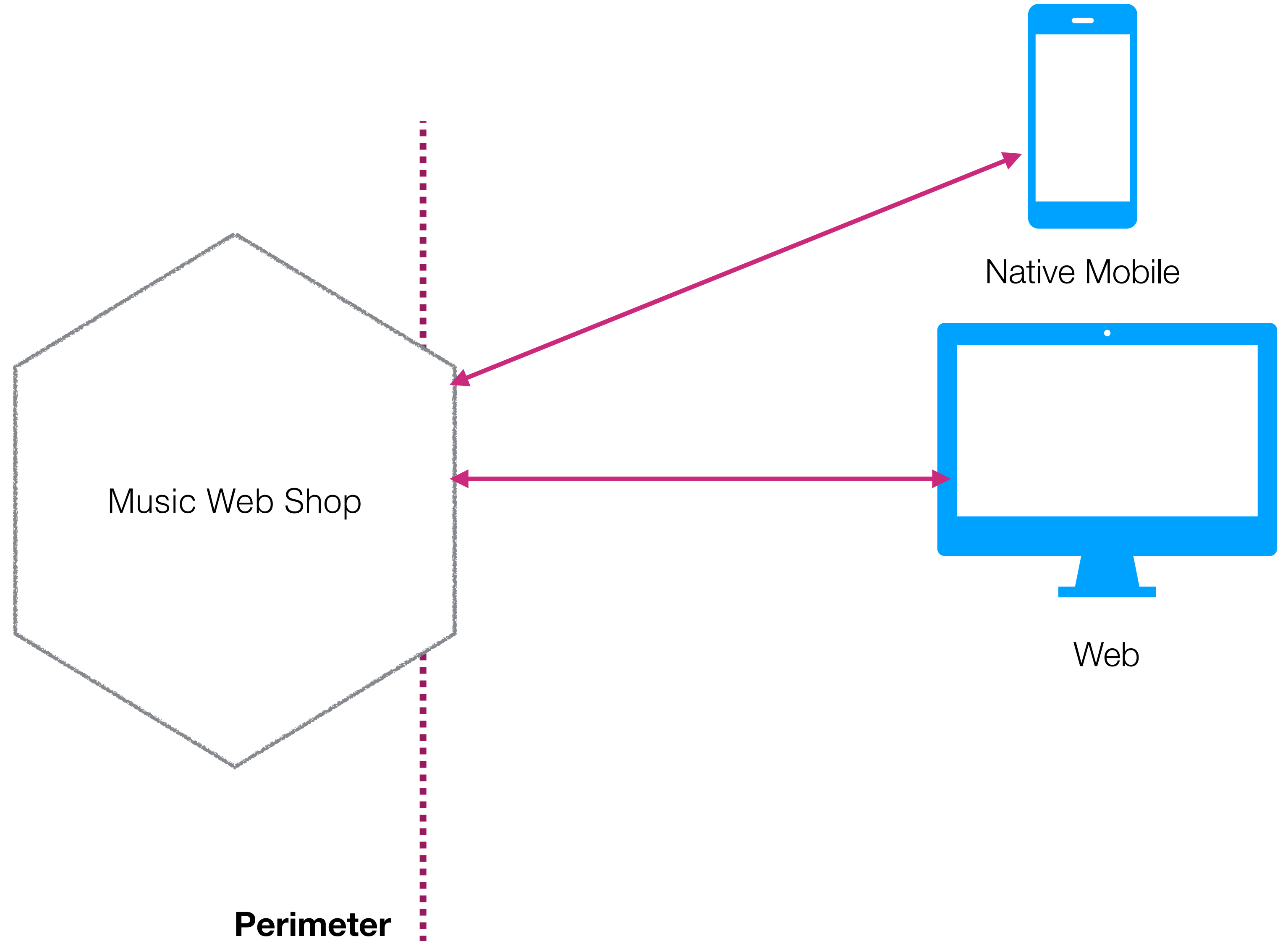

USER AUTHENTICATION - HANDLED IN SERVICE

Can reduce latency

Service potentially exposed to public internet

Self-contained

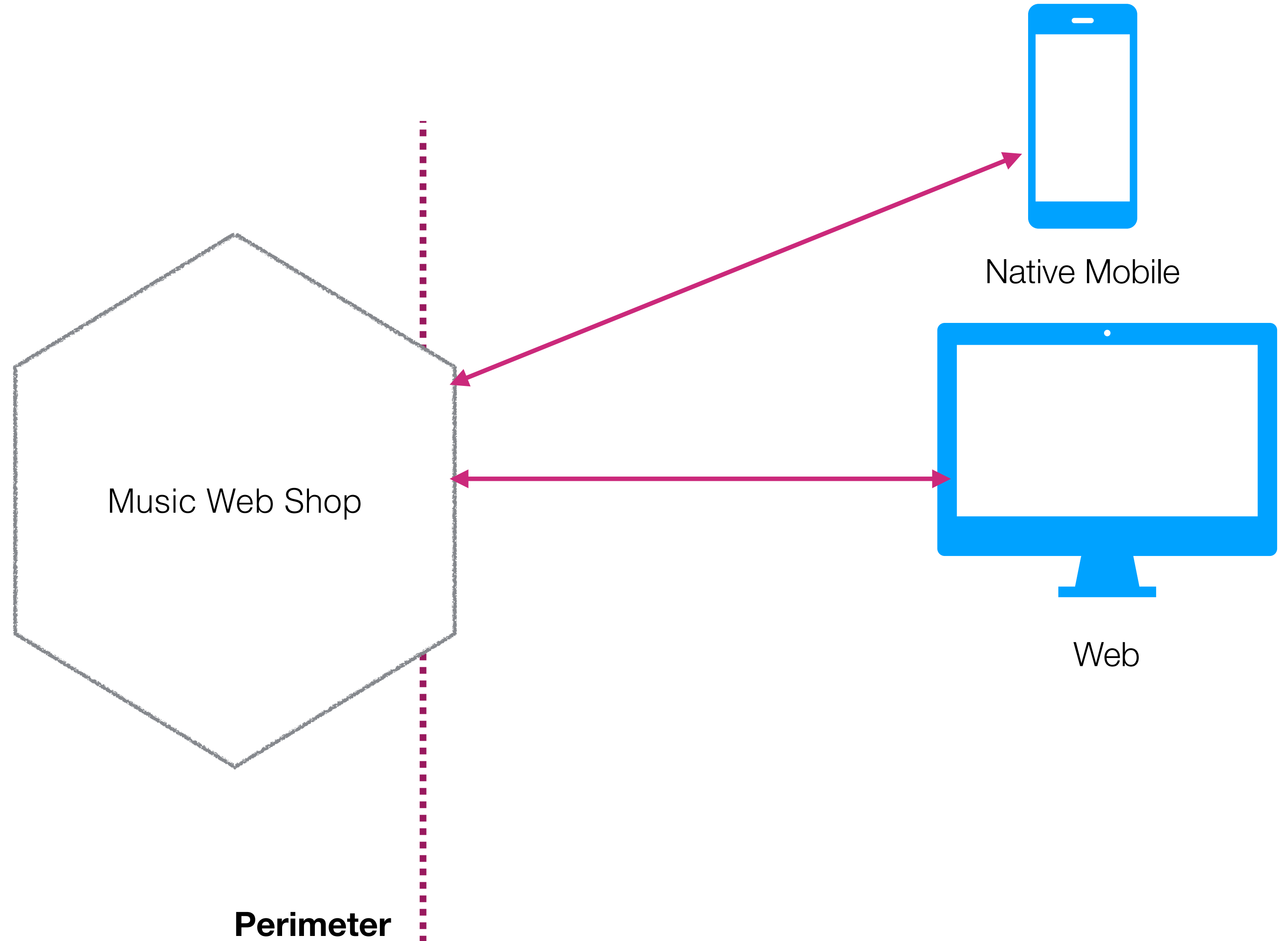

USER AUTHENTICATION - HANDLED IN SERVICE

Can reduce latency

Service potentially exposed to public internet

Self-contained

Code reuse?

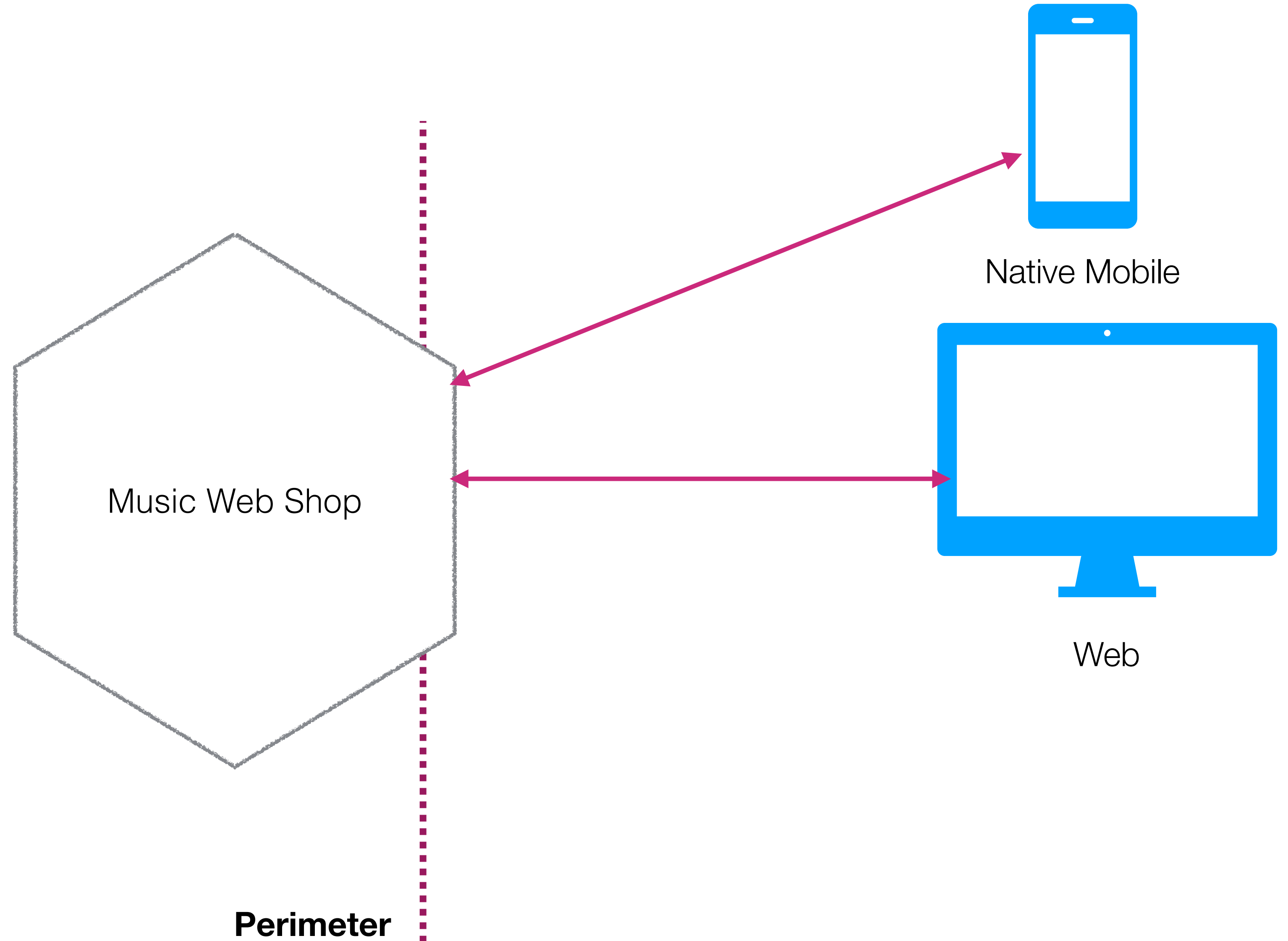

Perimeter

USER AUTHENTICATION - LIBRARY-BASED

Re-use authentication flow code via library

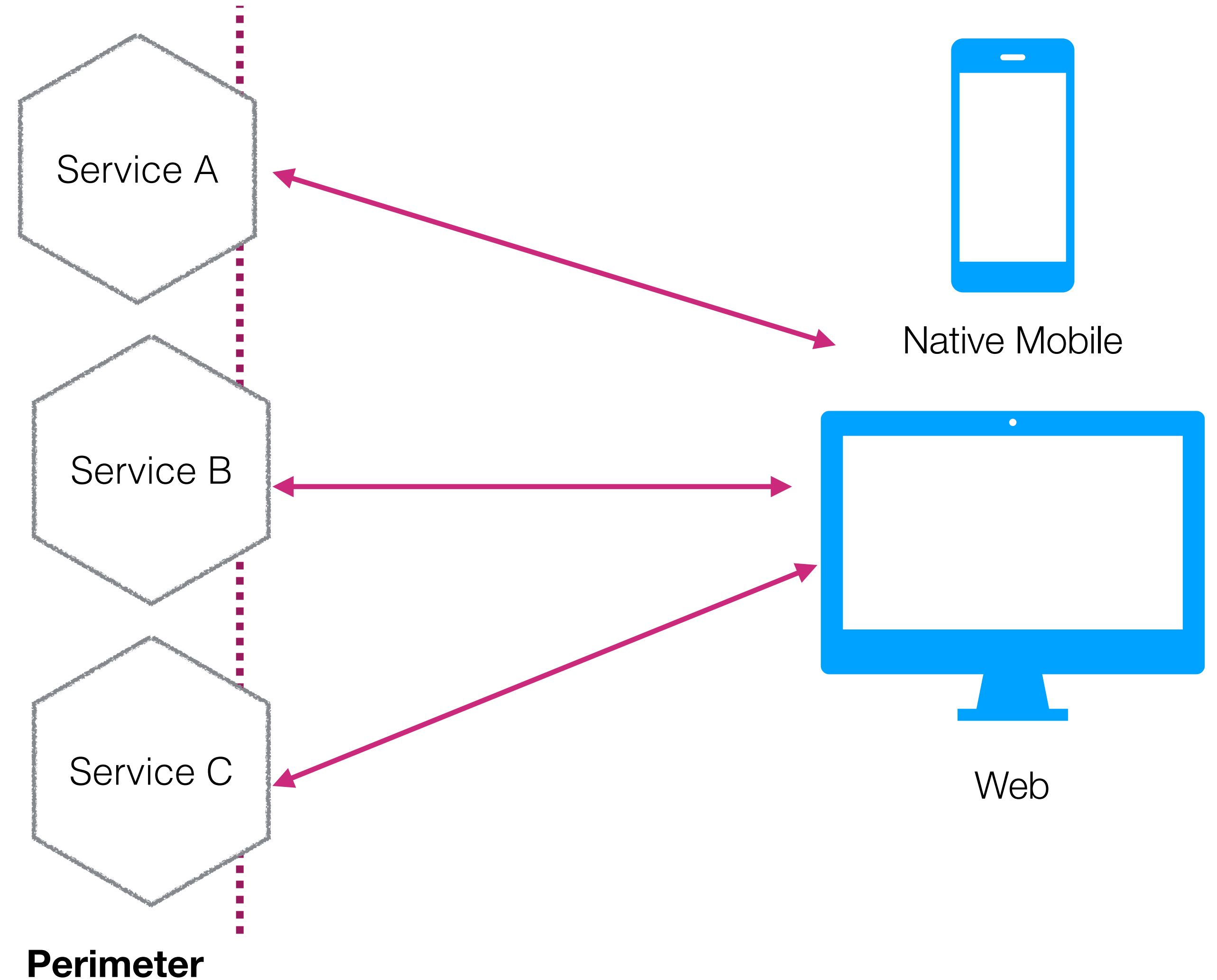

USER AUTHENTICATION - LIBRARY-BASED

Re-use authentication flow code via library

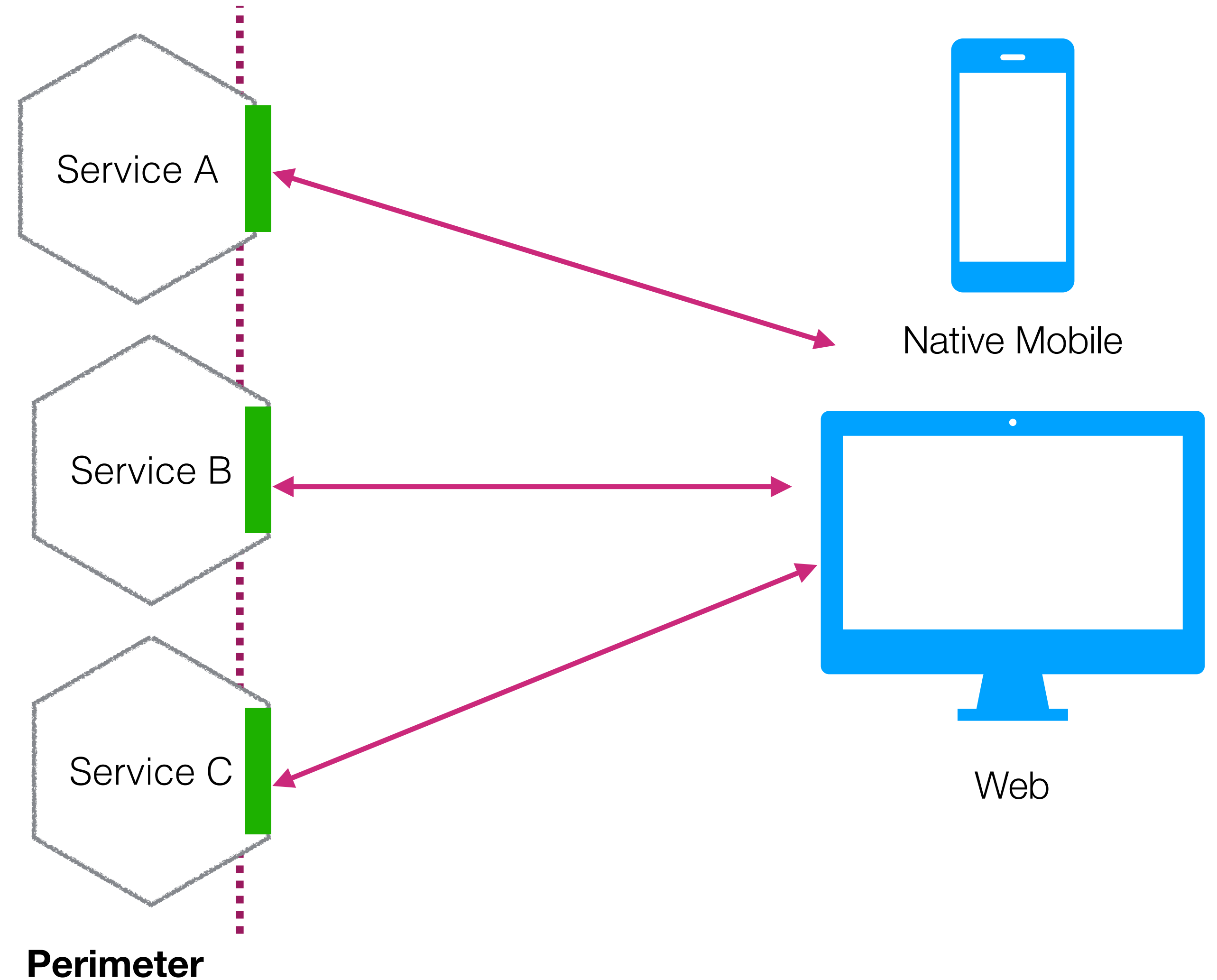

USER AUTHENTICATION - LIBRARY-BASED

Re-use authentication flow code via library

Version drift?

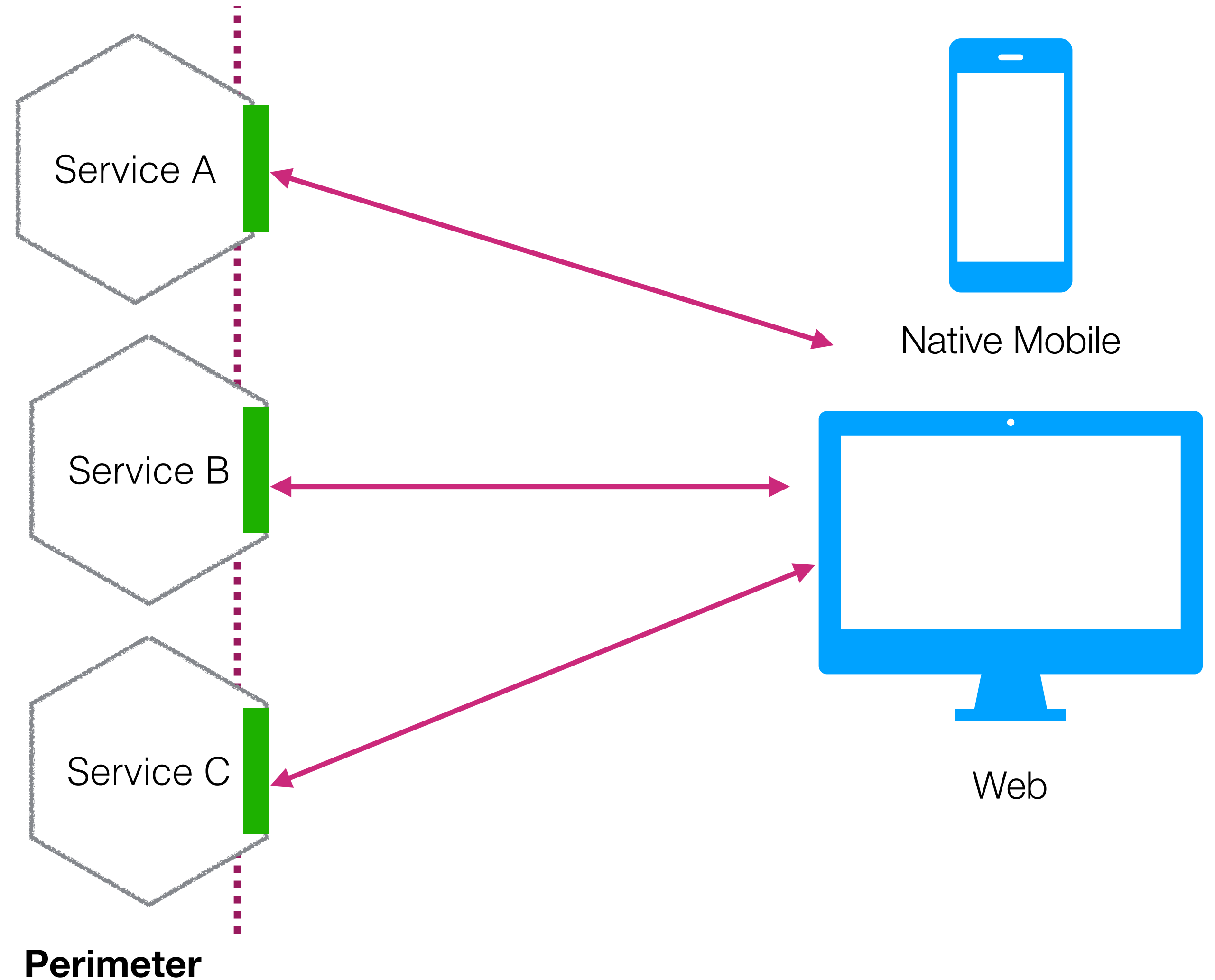

USER AUTHENTICATION - LIBRARY-BASED

Re-use authentication flow code via library

Version drift?

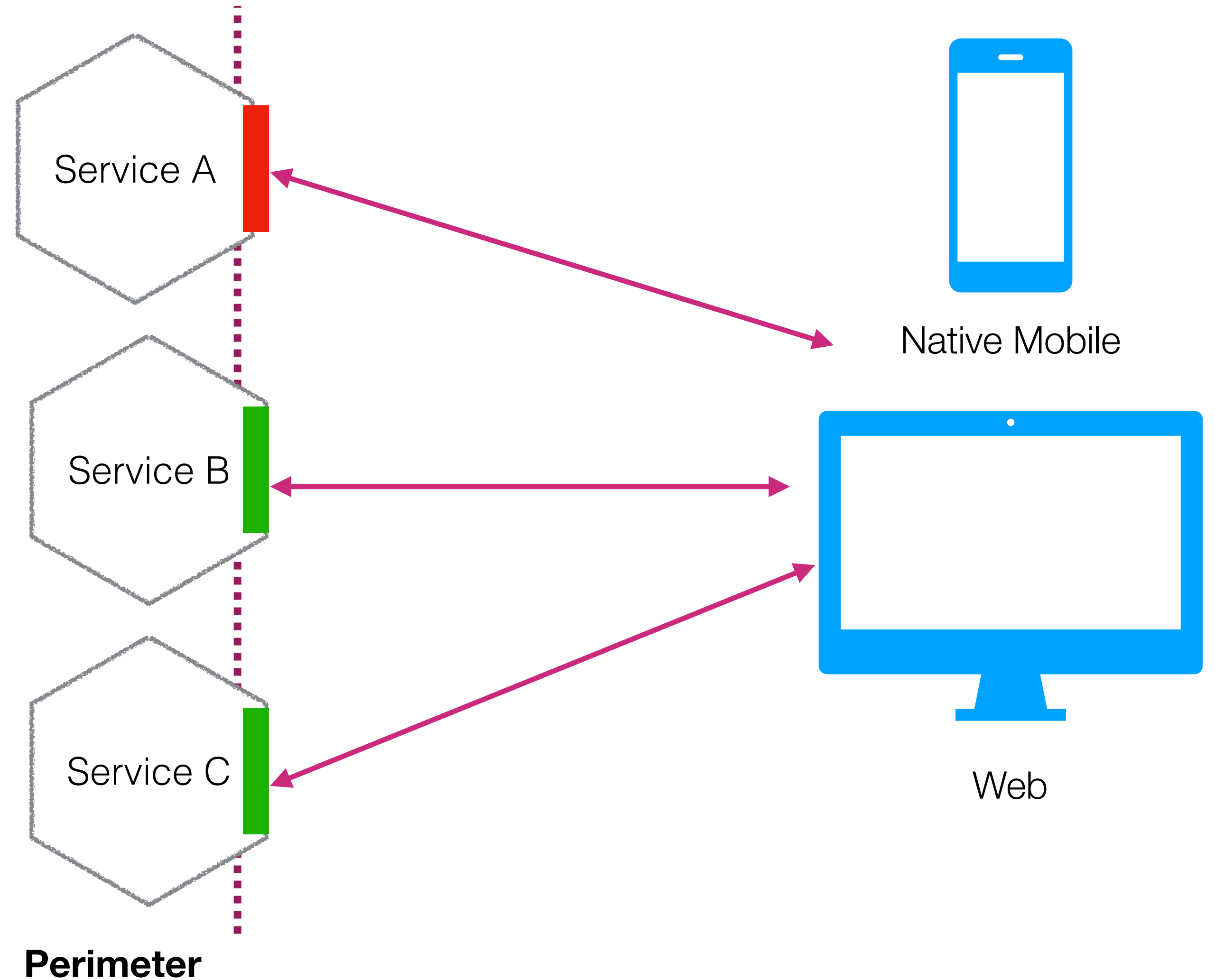

What about authorisation?

DO YOU EVEN AUTH?

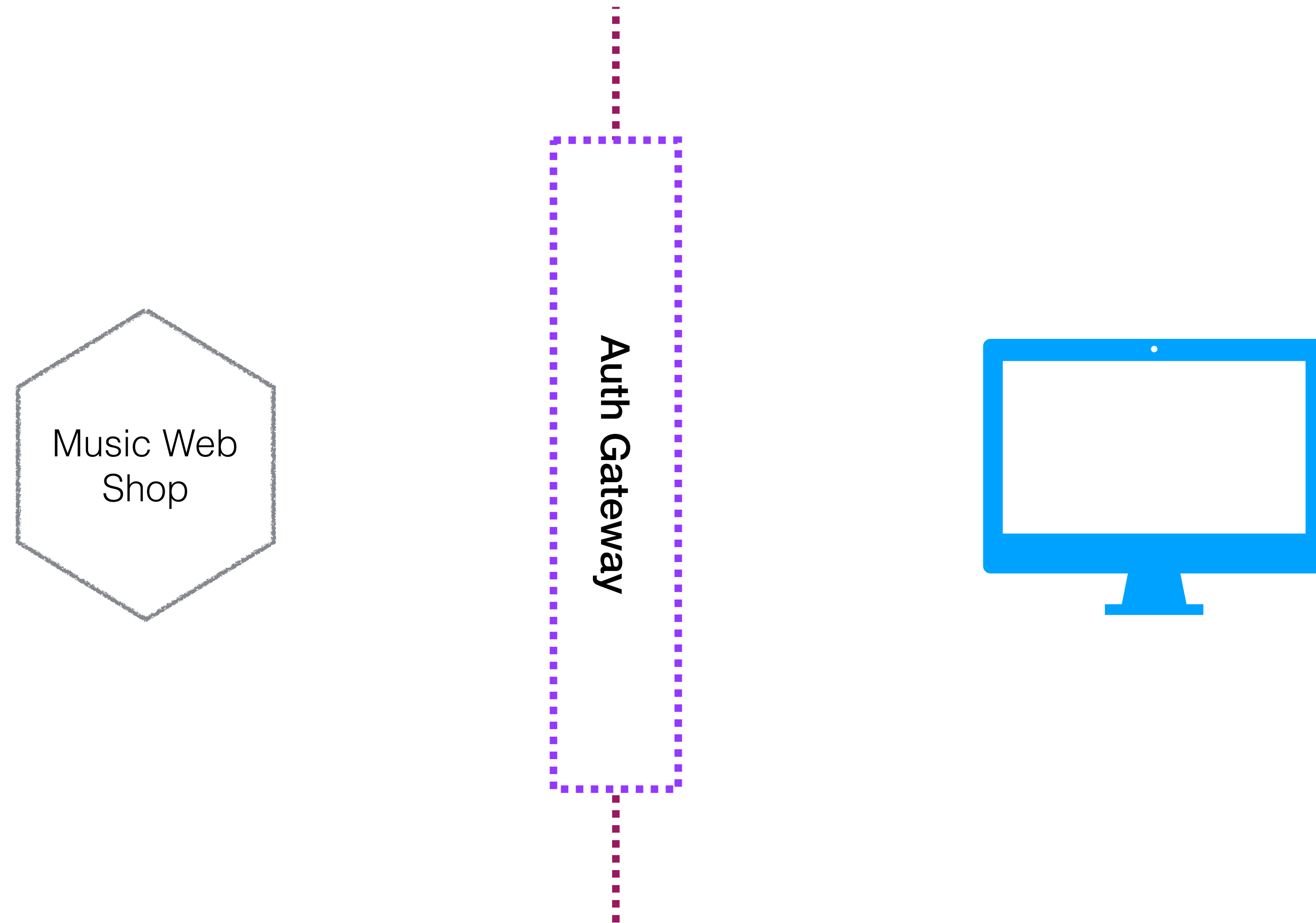

DO YOU EVEN AUTH?

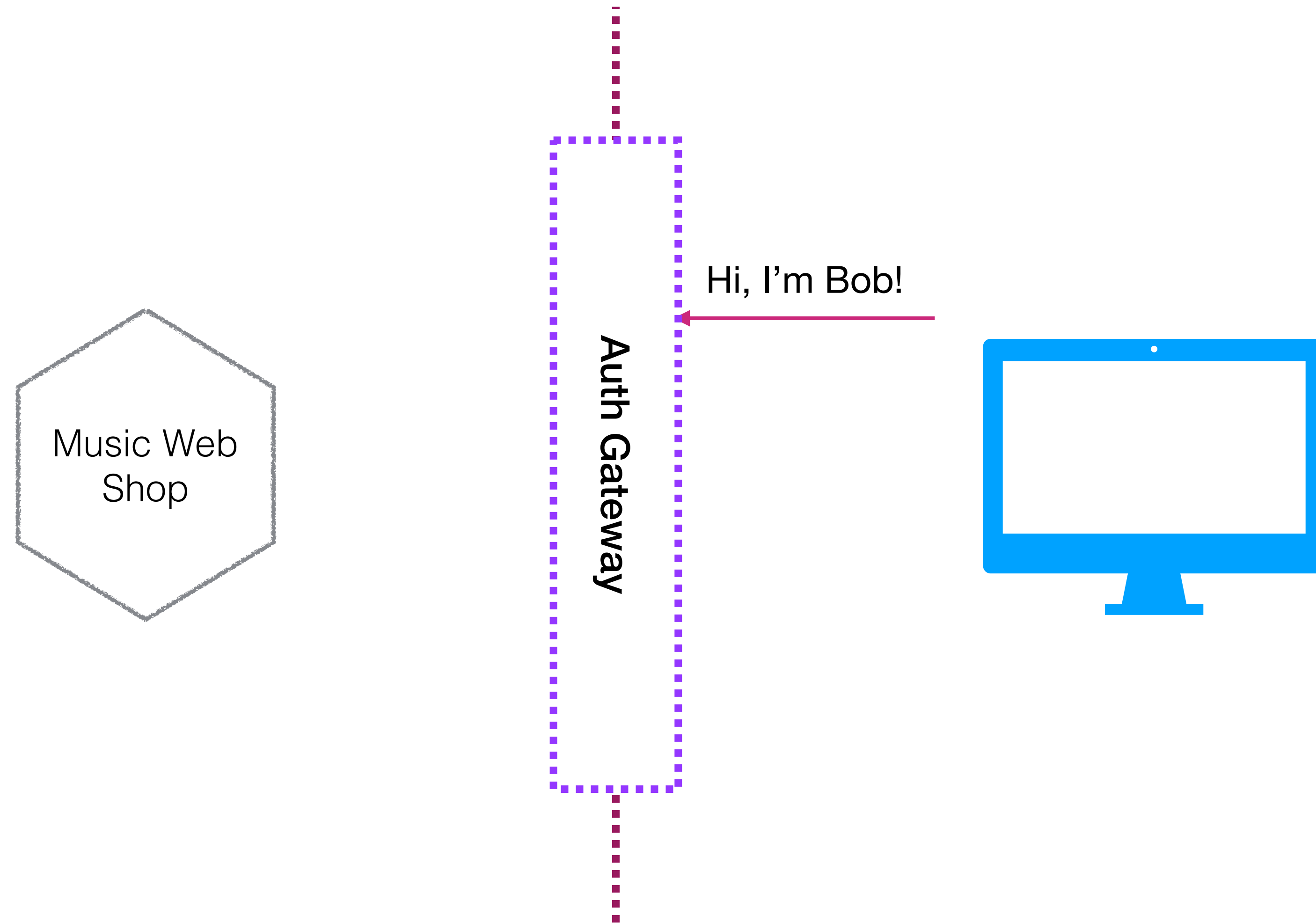

DO YOU EVEN AUTH?

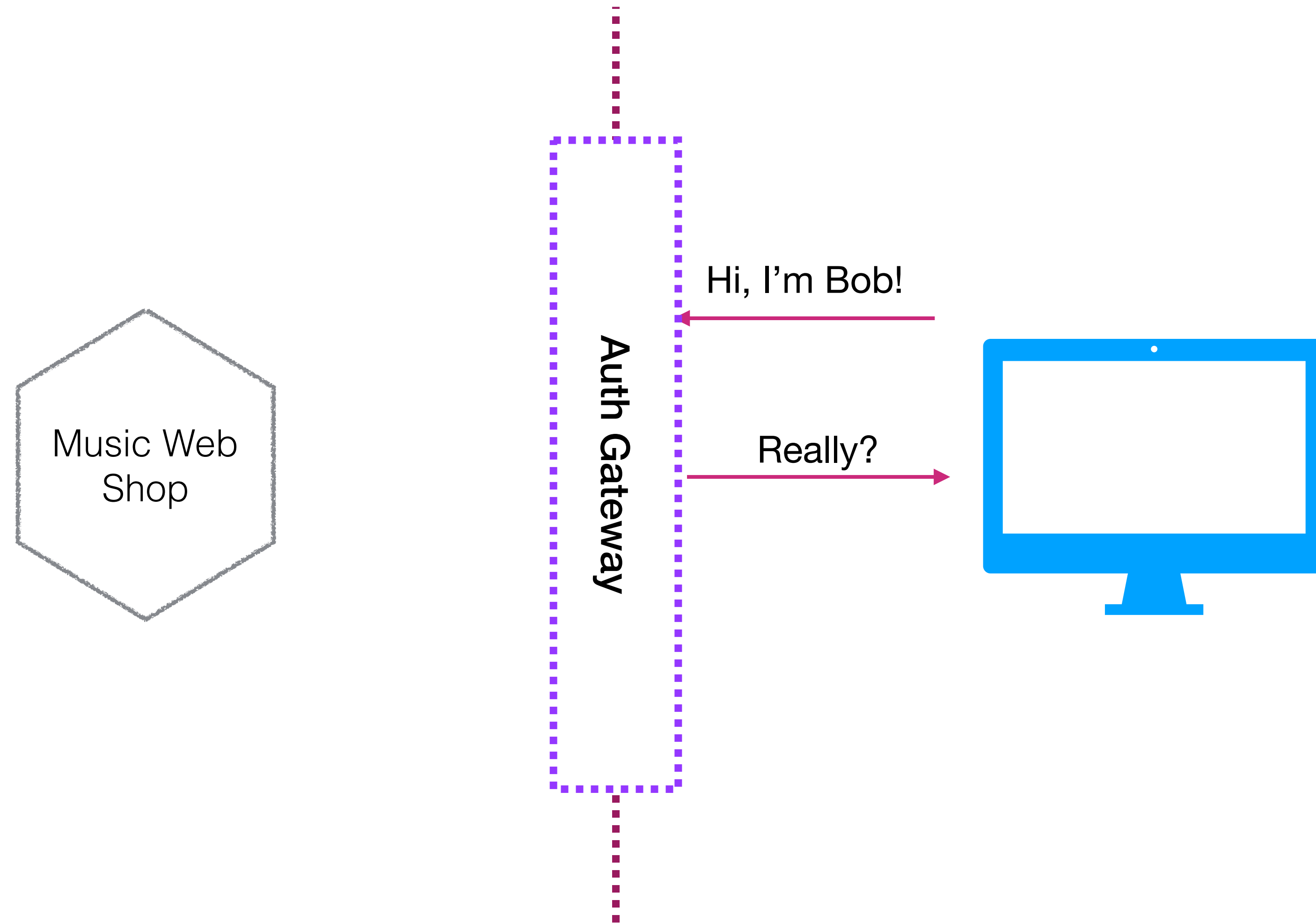

DO YOU EVEN AUTH?

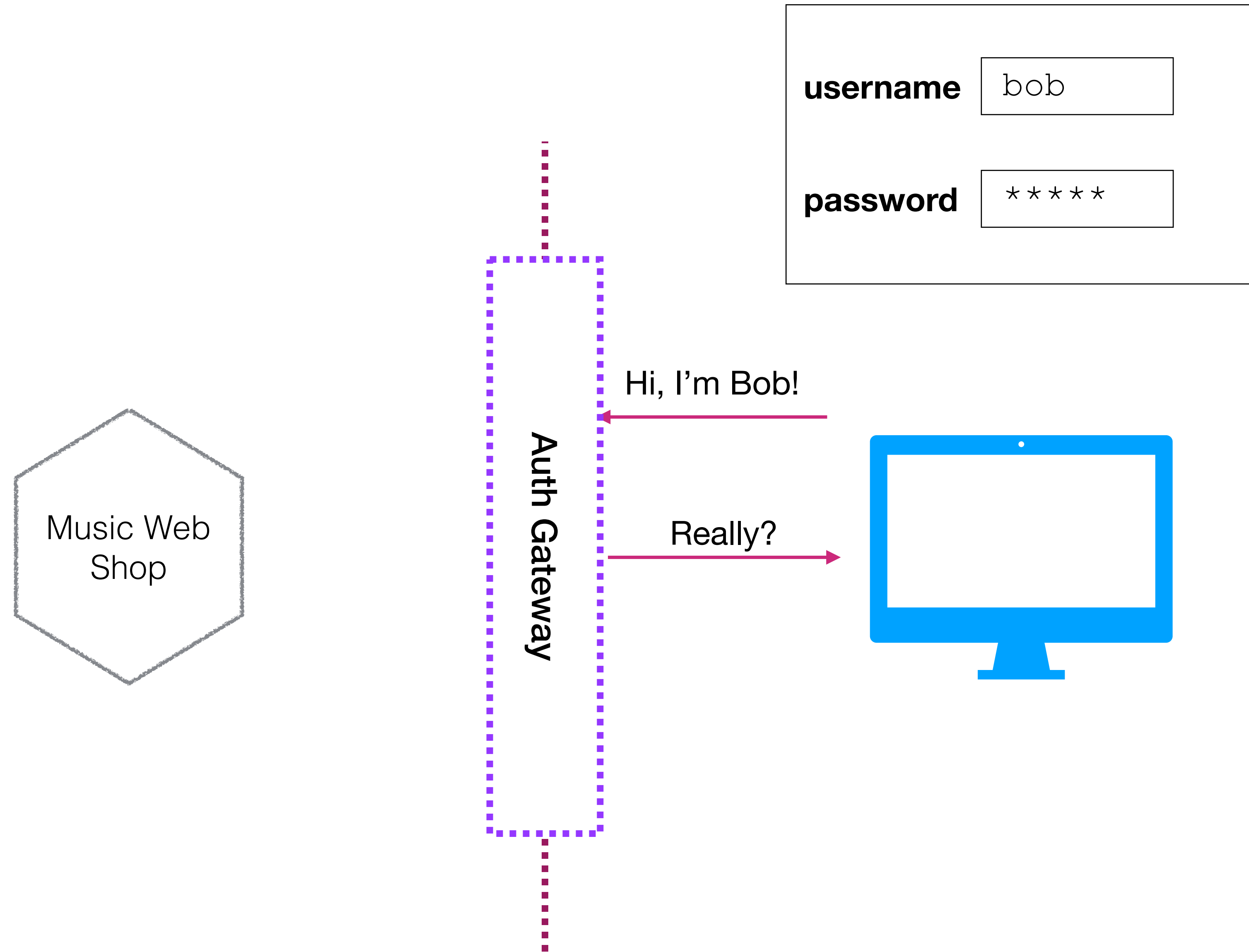

DO YOU EVEN AUTH?

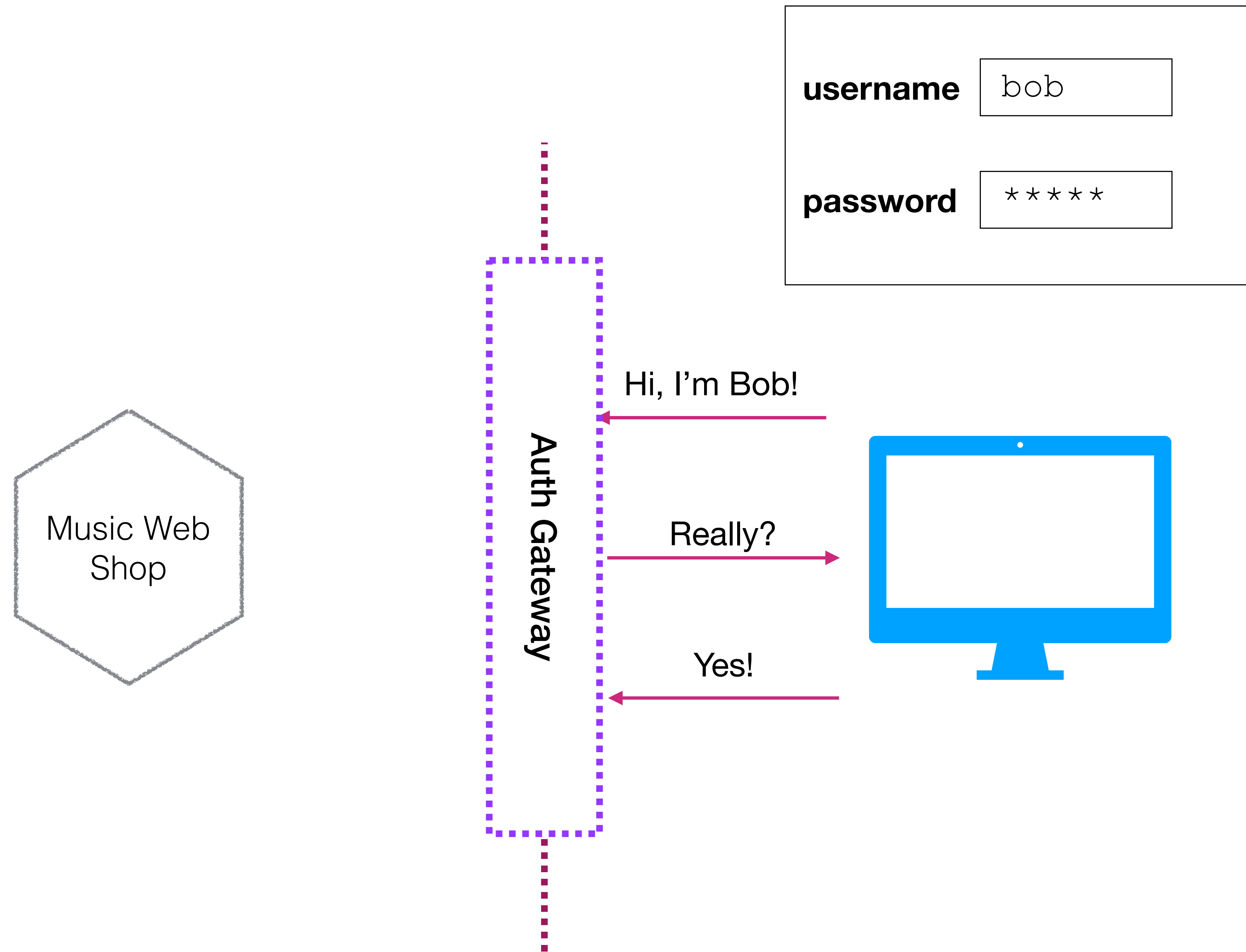

DO YOU EVEN AUTH?

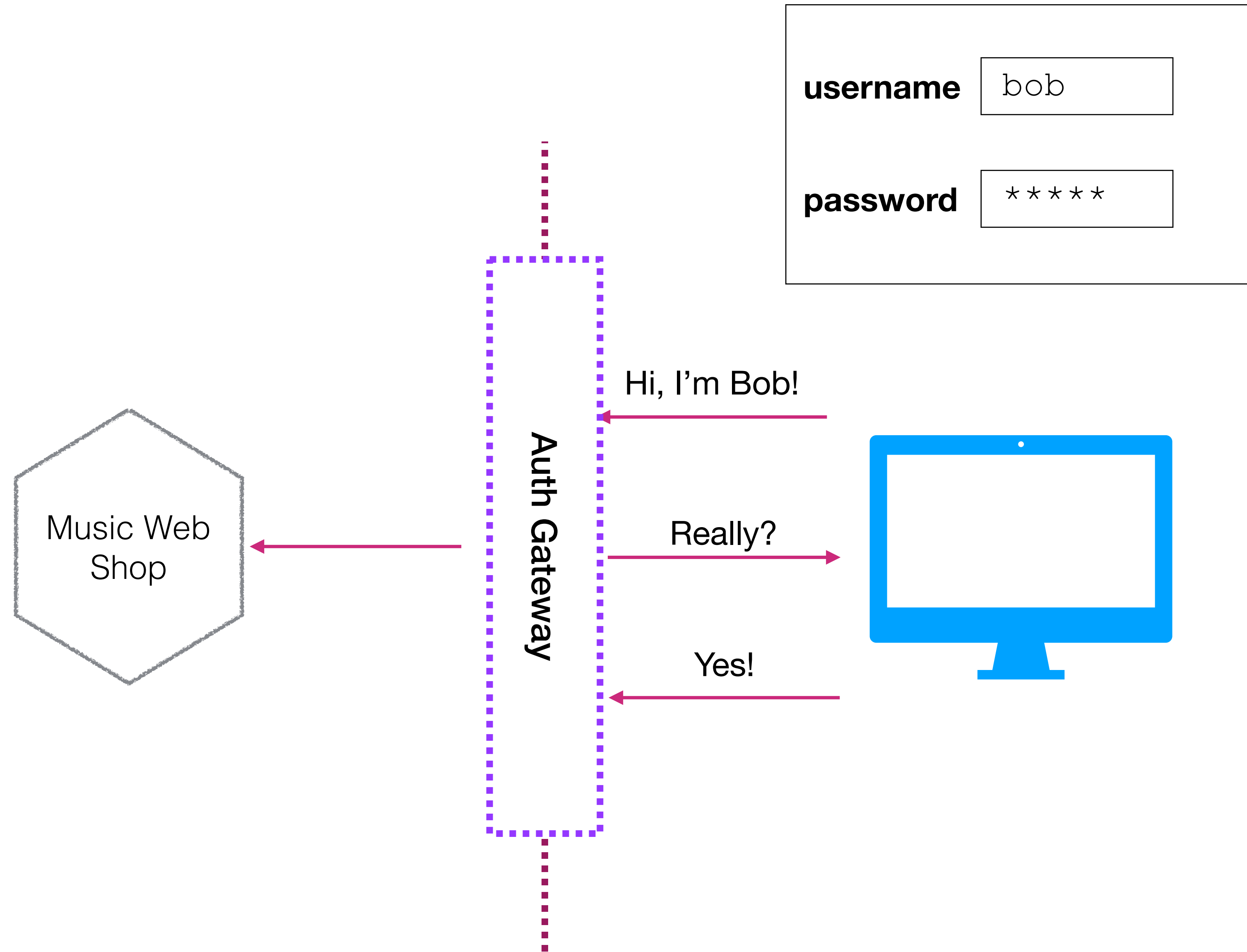

DO YOU EVEN AUTH?

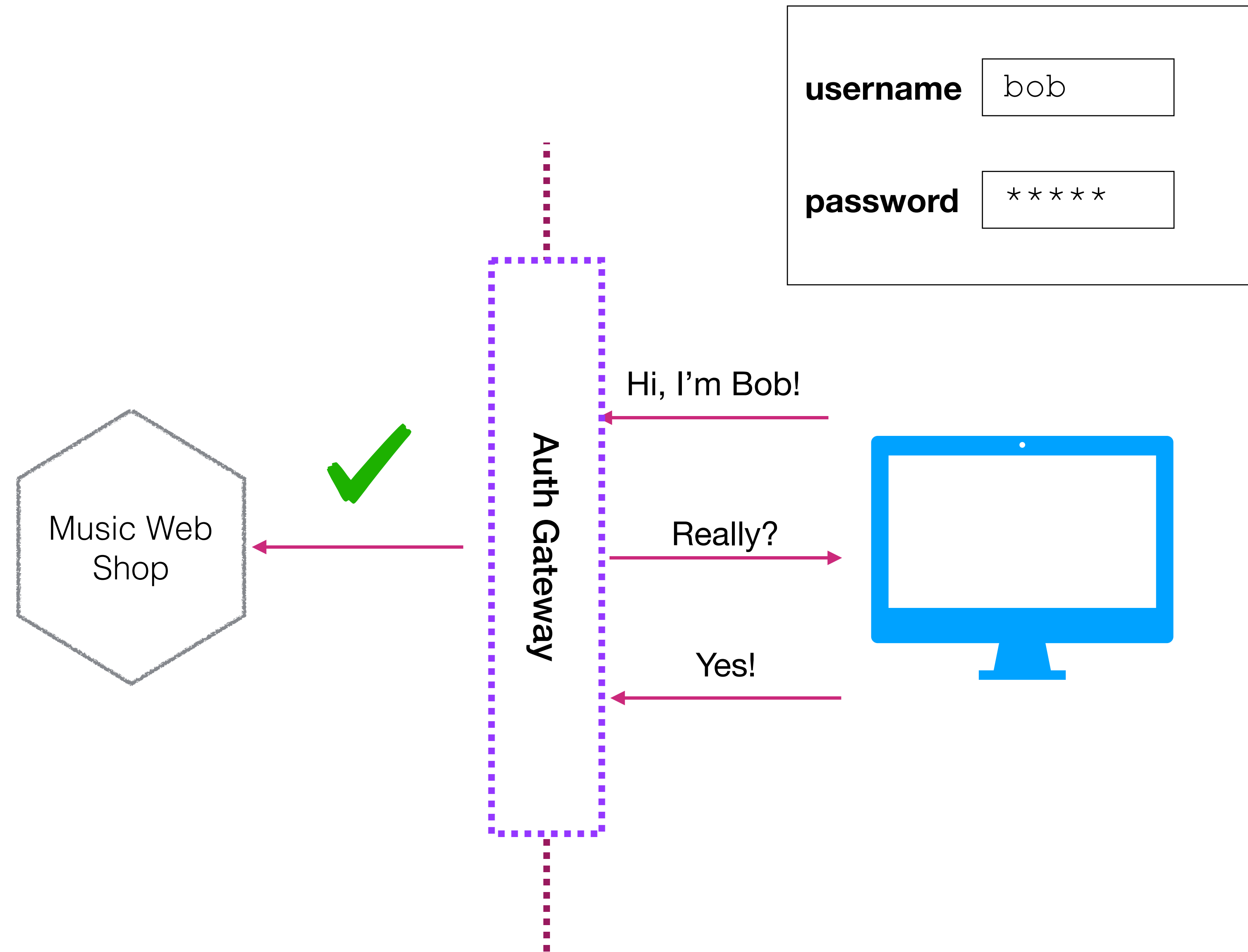

DOWNSTREAM AUTH - IMPLICIT TRUST?

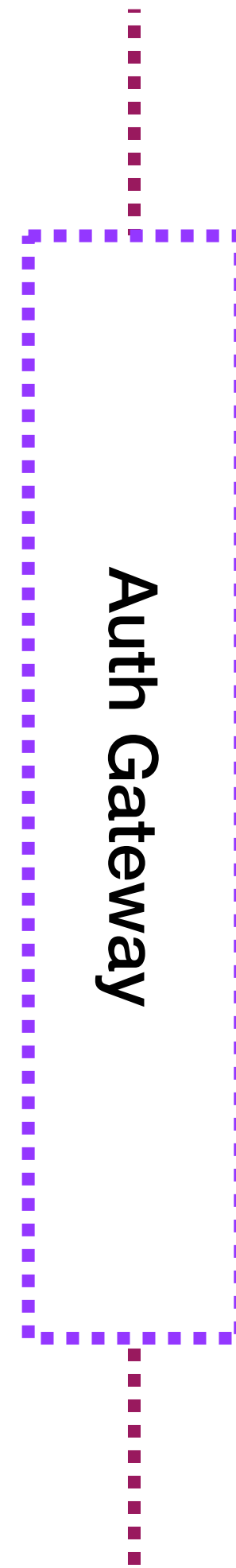
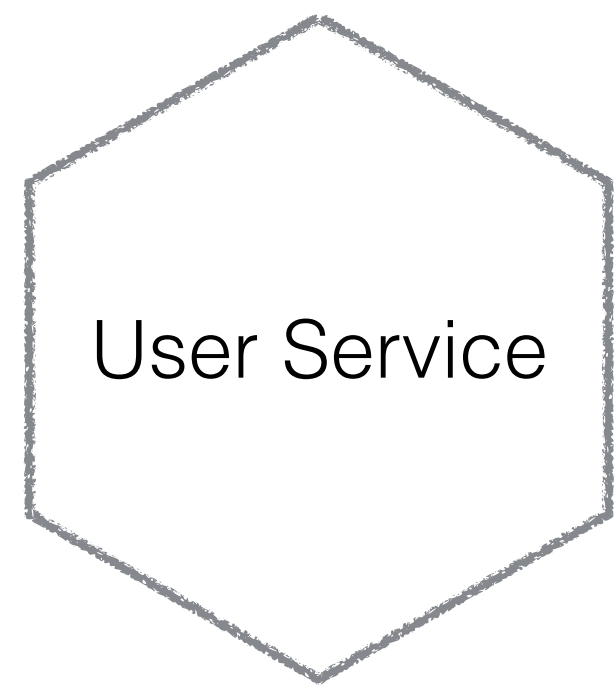

Logged in as Bob

DOWNSTREAM AUTH - IMPLICIT TRUST?

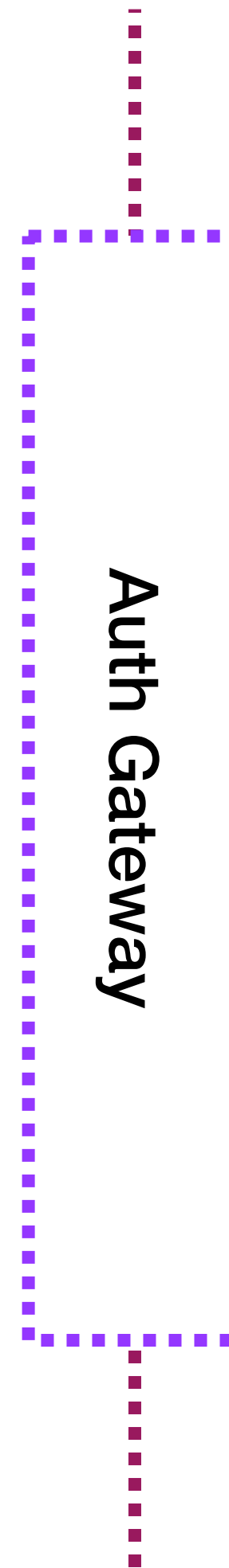
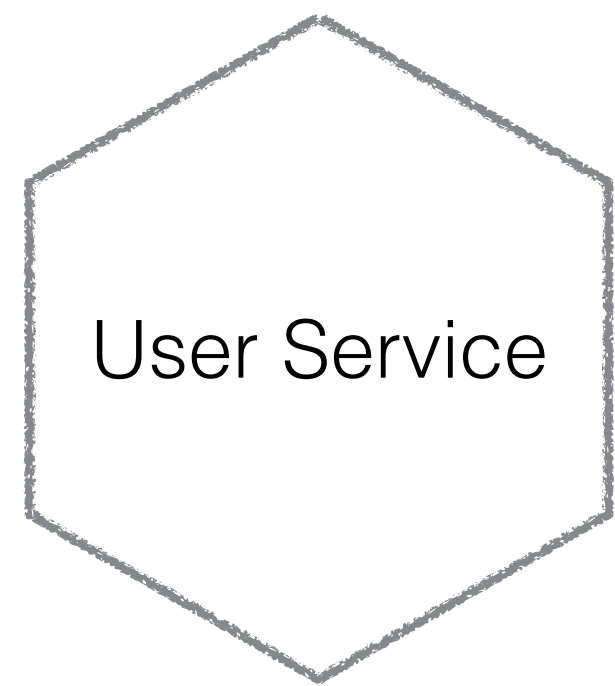

<http://www.music-corp.com/user/bob>



Logged in as Bob

DOWNSTREAM AUTH - IMPLICIT TRUST?

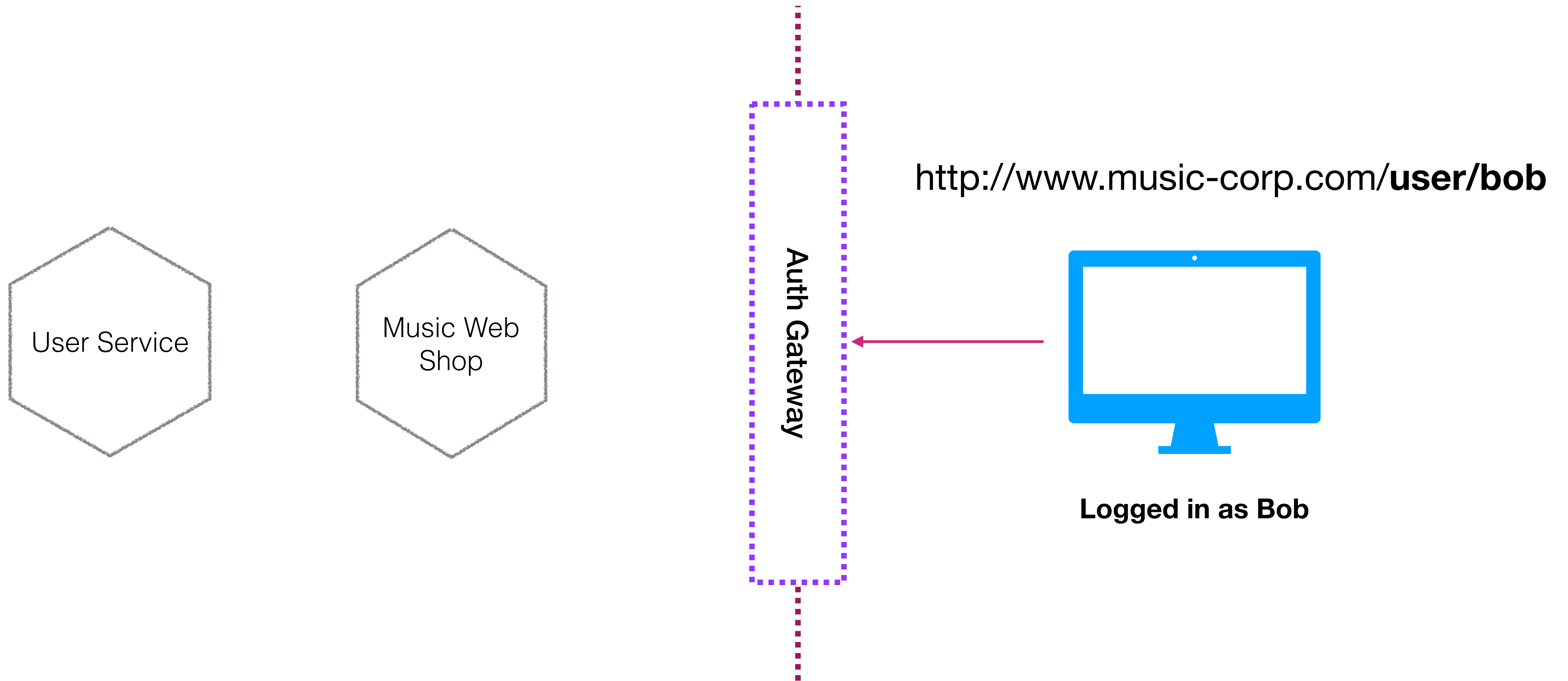

DOWNSTREAM AUTH - IMPLICIT TRUST?

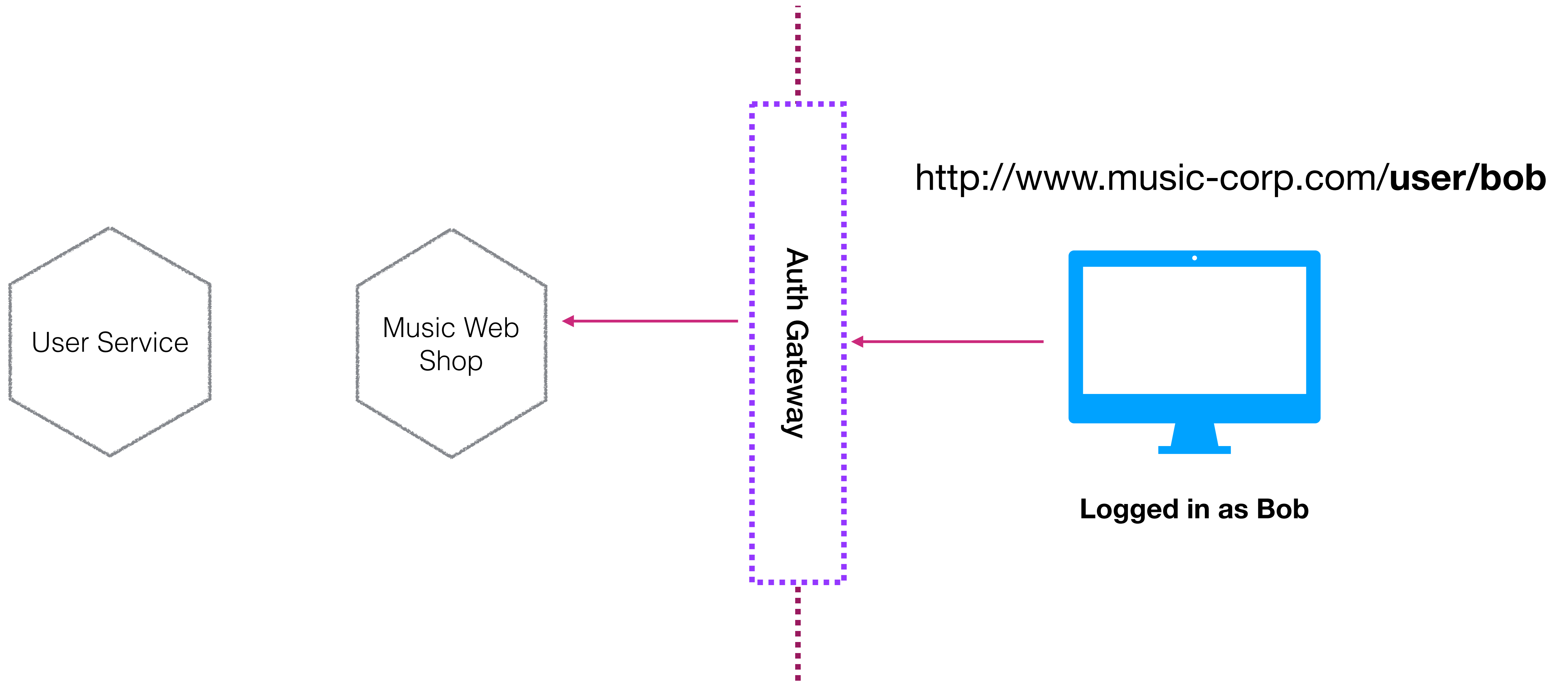

DOWNSTREAM AUTH - IMPLICIT TRUST?

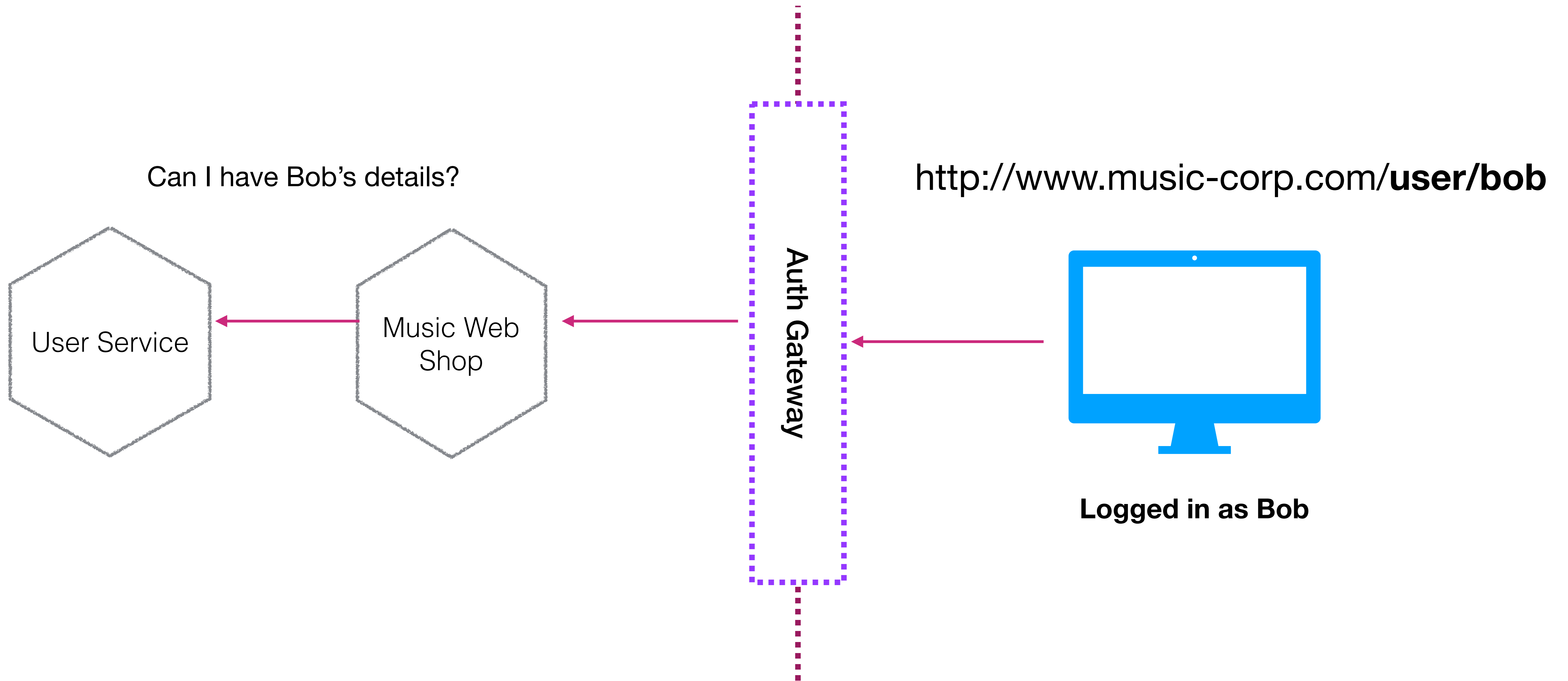

DOWNSTREAM AUTH - IMPLICIT TRUST?

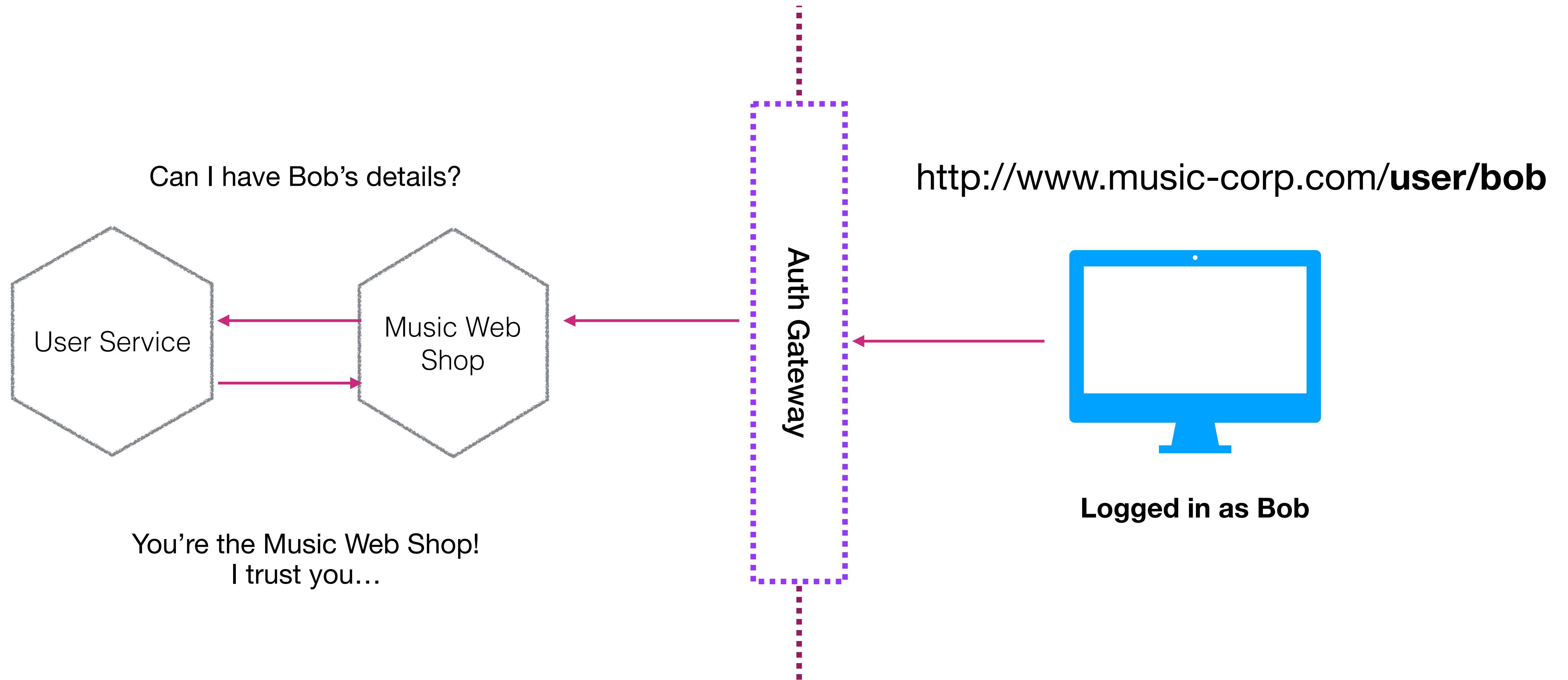

DOWNSTREAM AUTH - IMPLICIT TRUST?

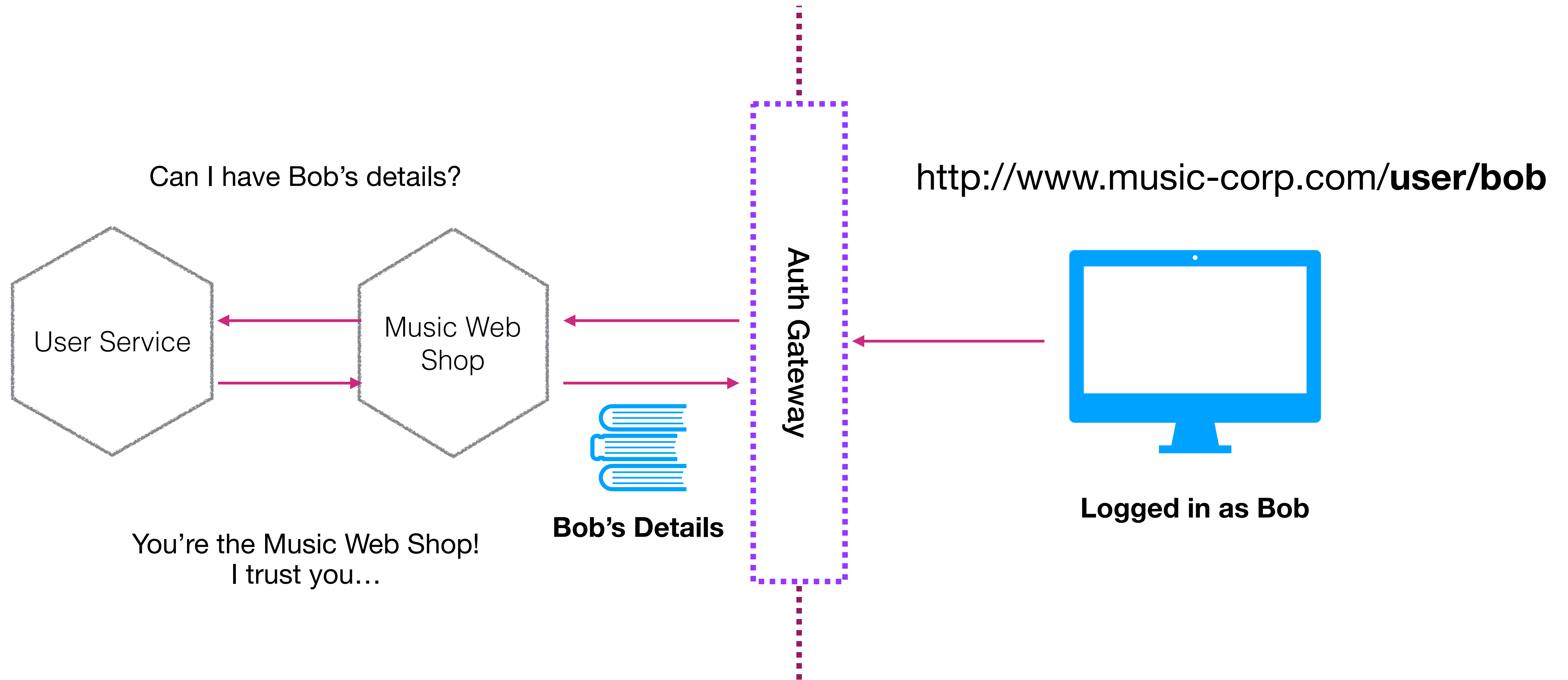

DOWNSTREAM AUTH - IMPLICIT TRUST?

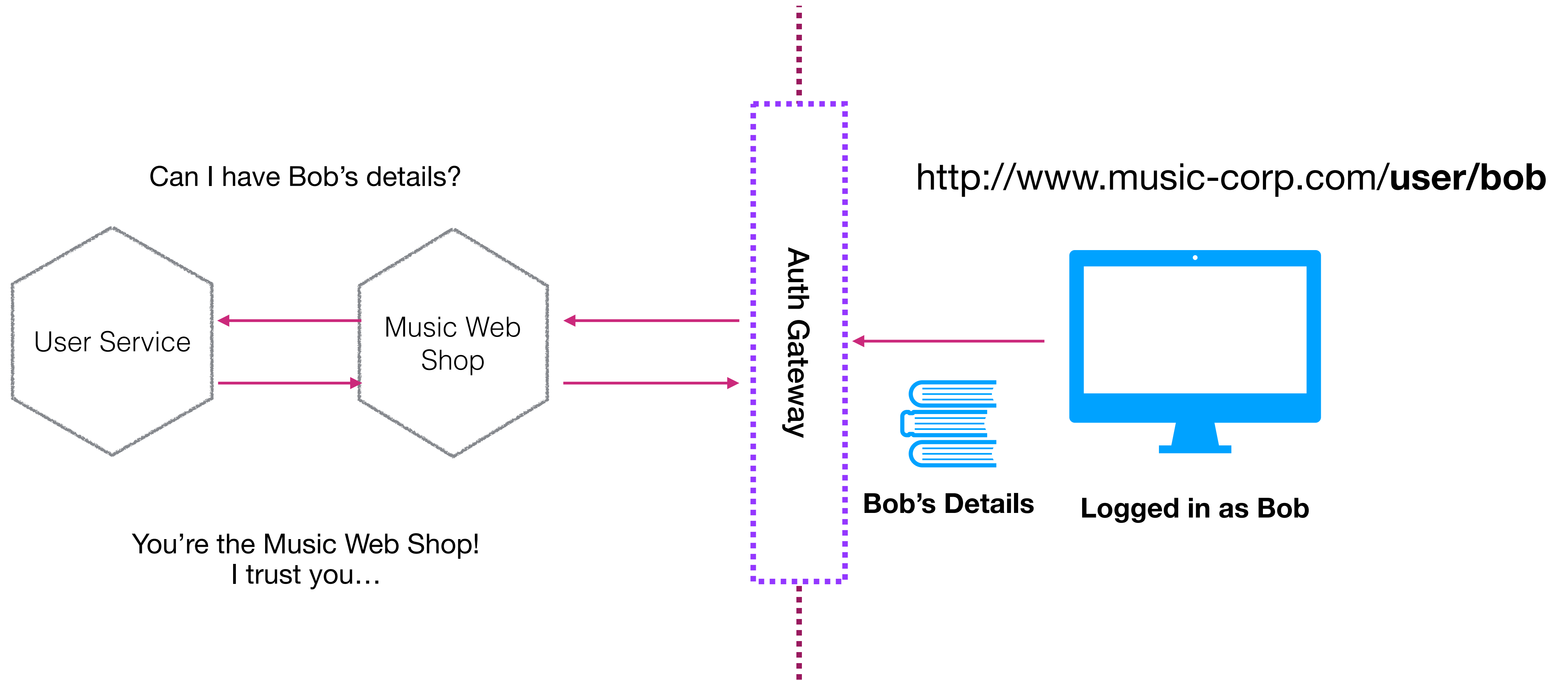

DOWNSTREAM AUTH - IMPLICIT TRUST?

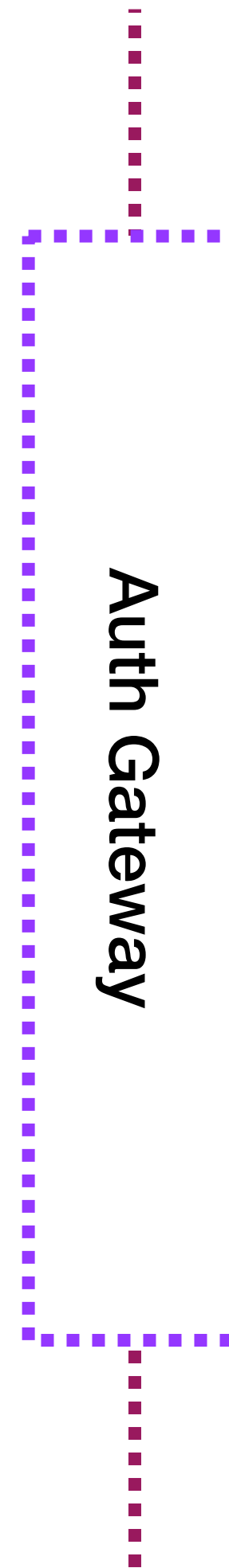
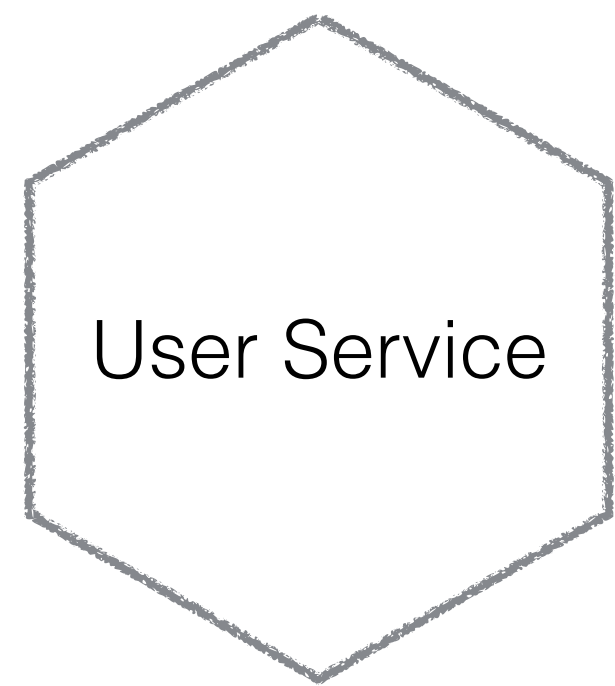

Logged in as Bob

DOWNSTREAM AUTH - IMPLICIT TRUST?

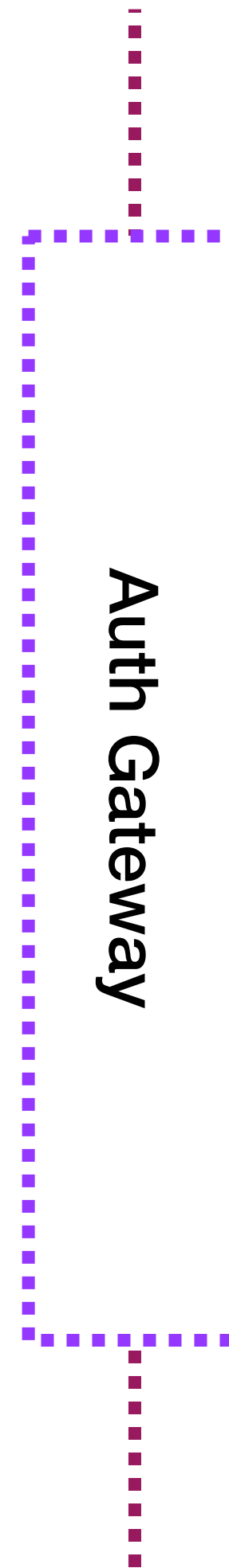
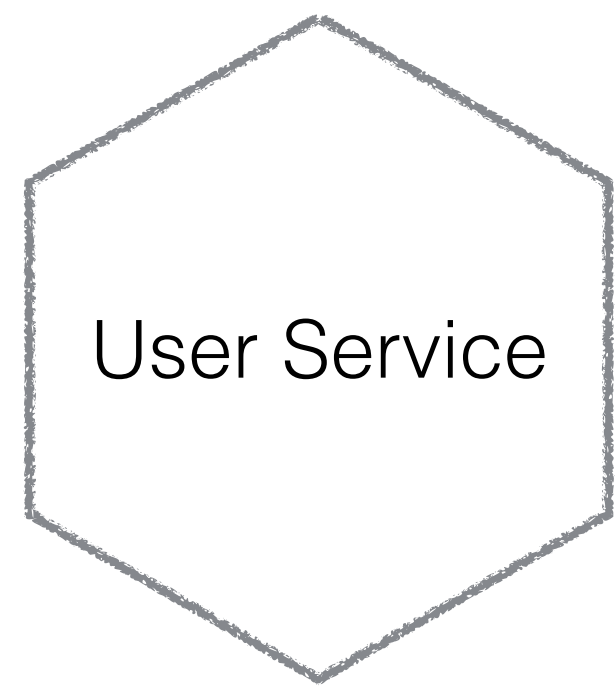

<http://www.music-corp.com/user/alice>



Logged in as Bob

DOWNSTREAM AUTH - IMPLICIT TRUST?

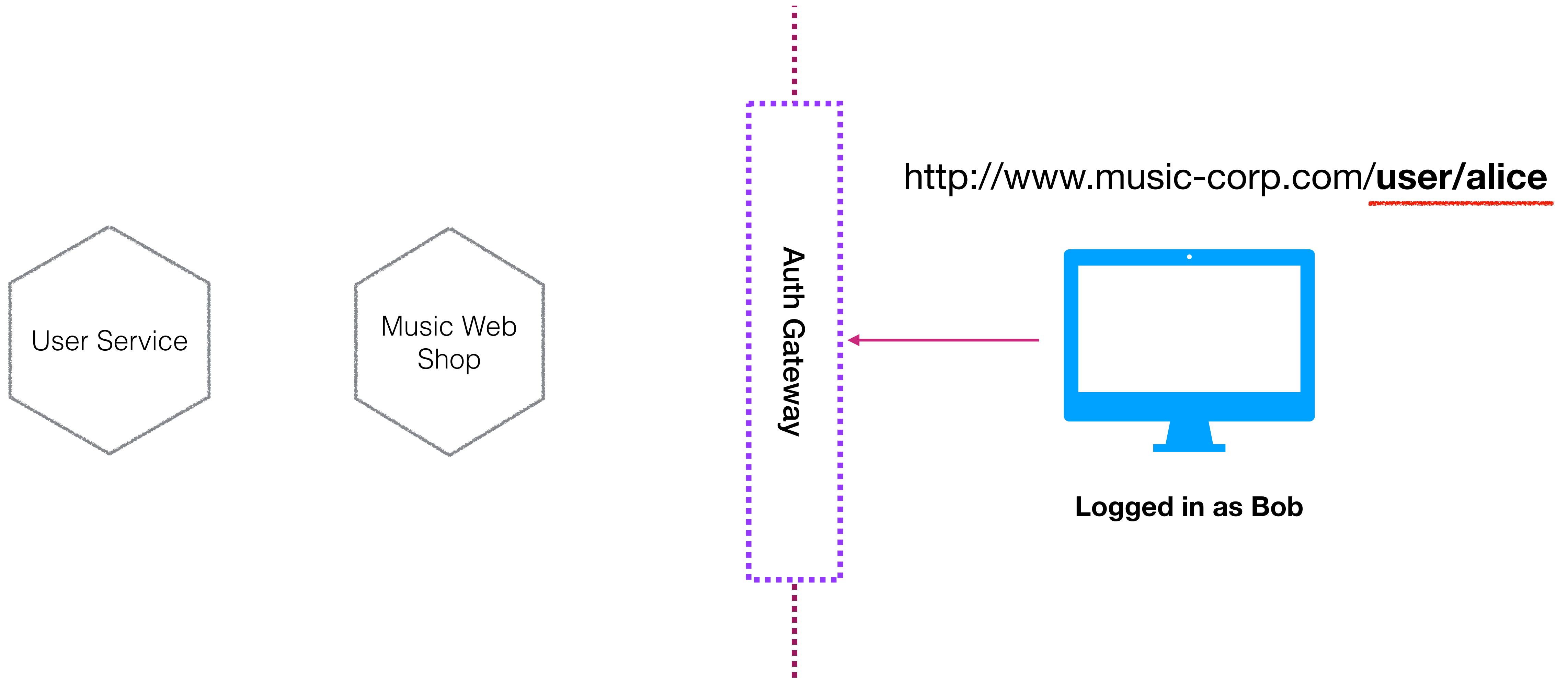

DOWNSTREAM AUTH - IMPLICIT TRUST?

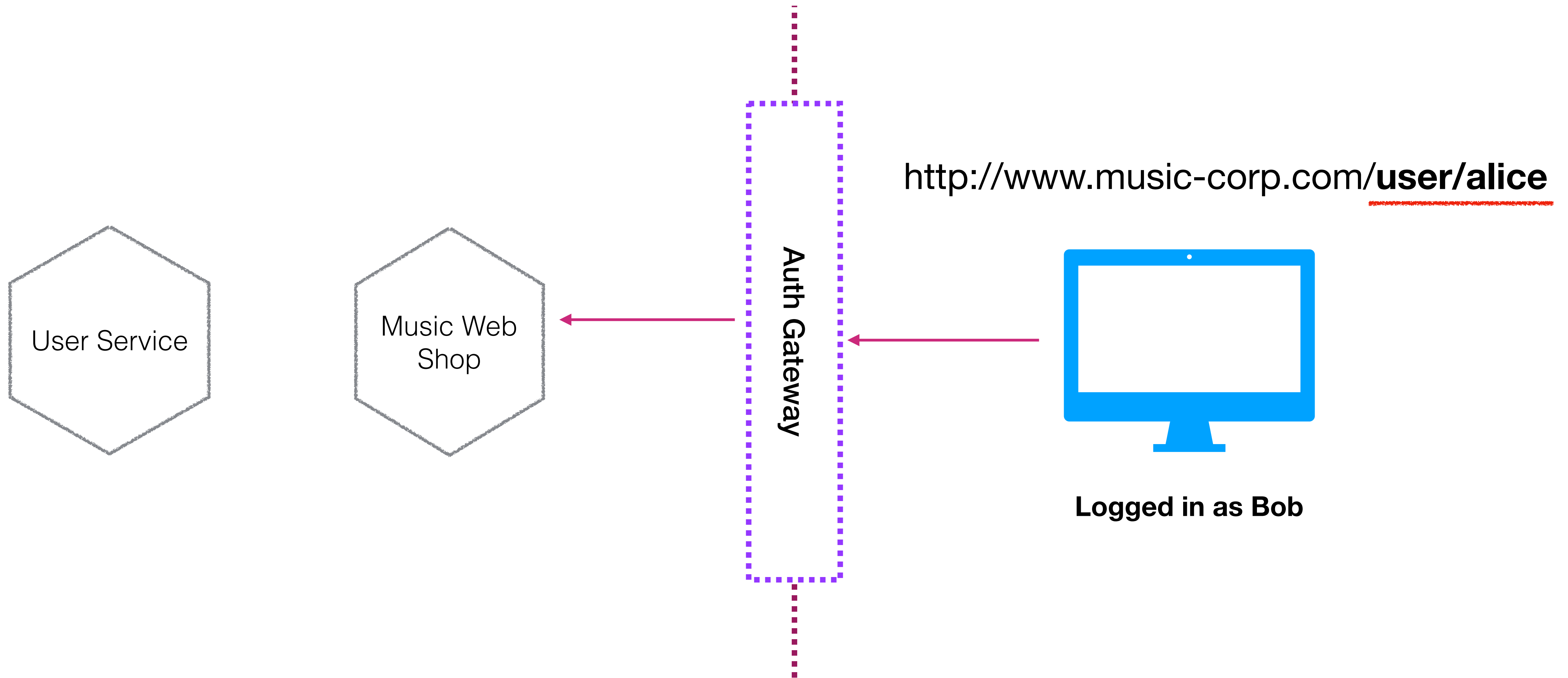

DOWNSTREAM AUTH - IMPLICIT TRUST?

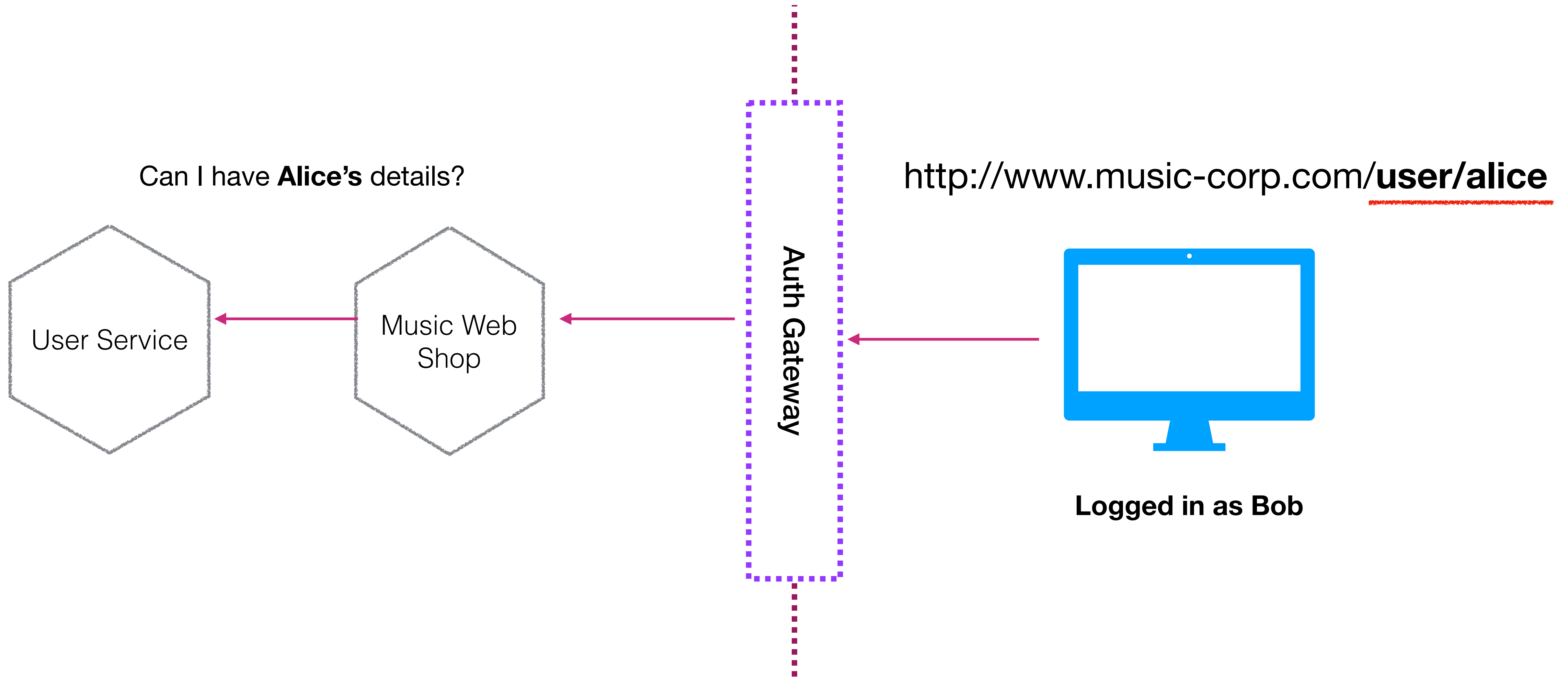

DOWNSTREAM AUTH - IMPLICIT TRUST?

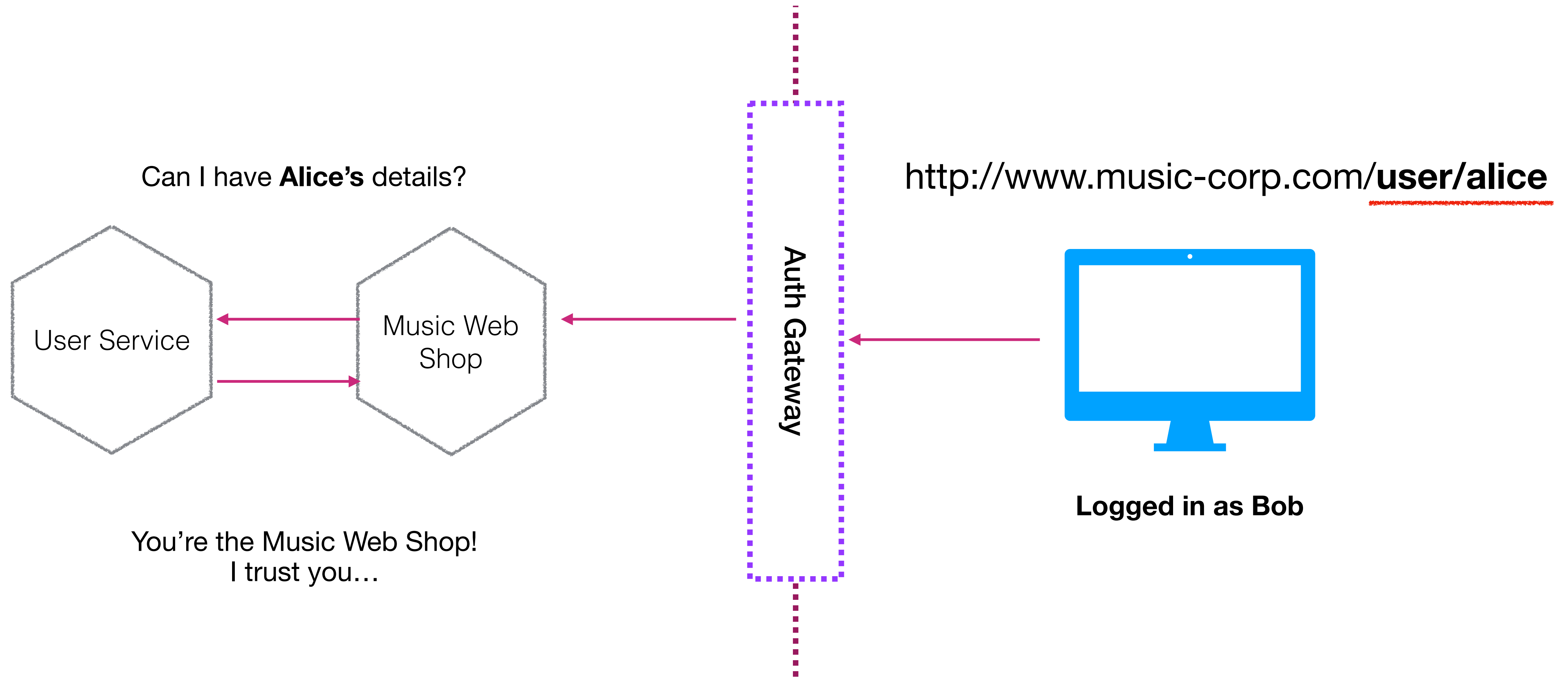

DOWNSTREAM AUTH - IMPLICIT TRUST?

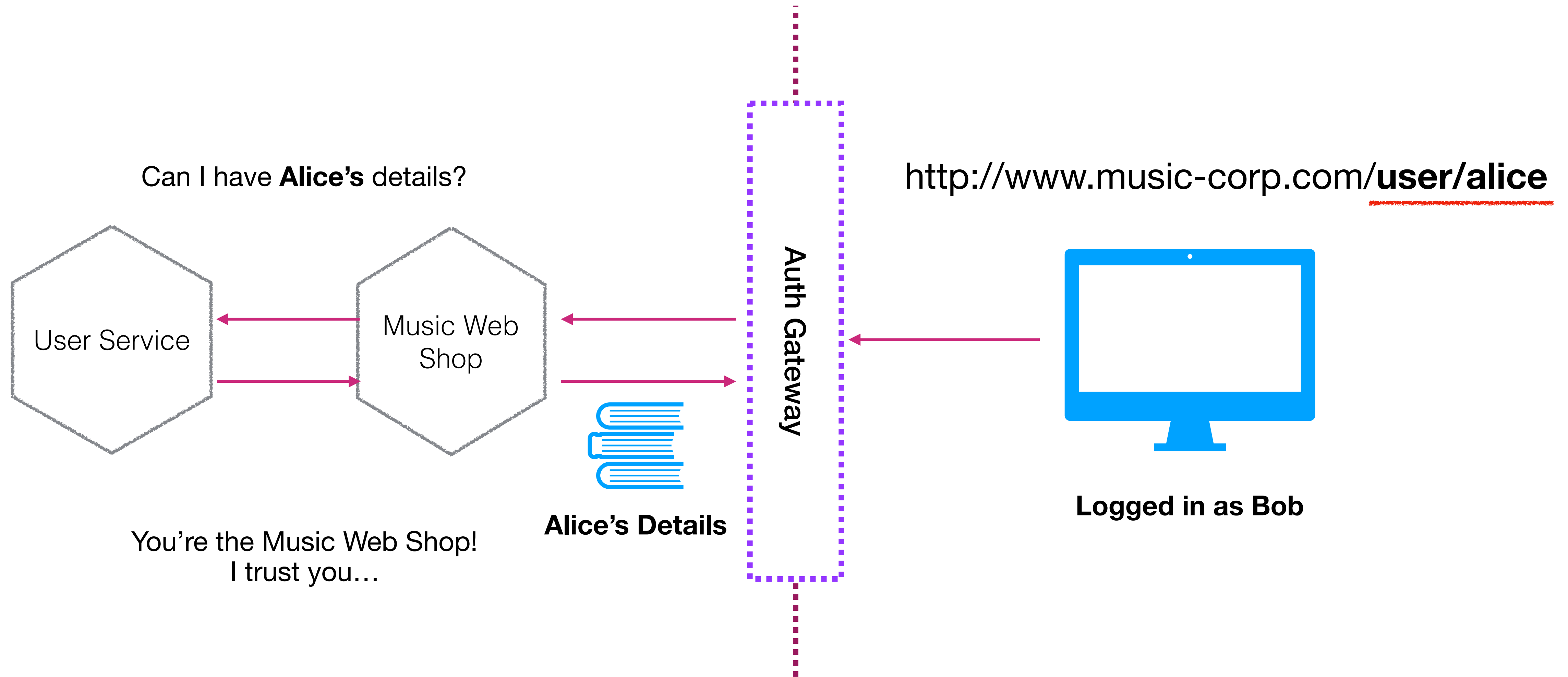

DOWNSTREAM AUTH - IMPLICIT TRUST?

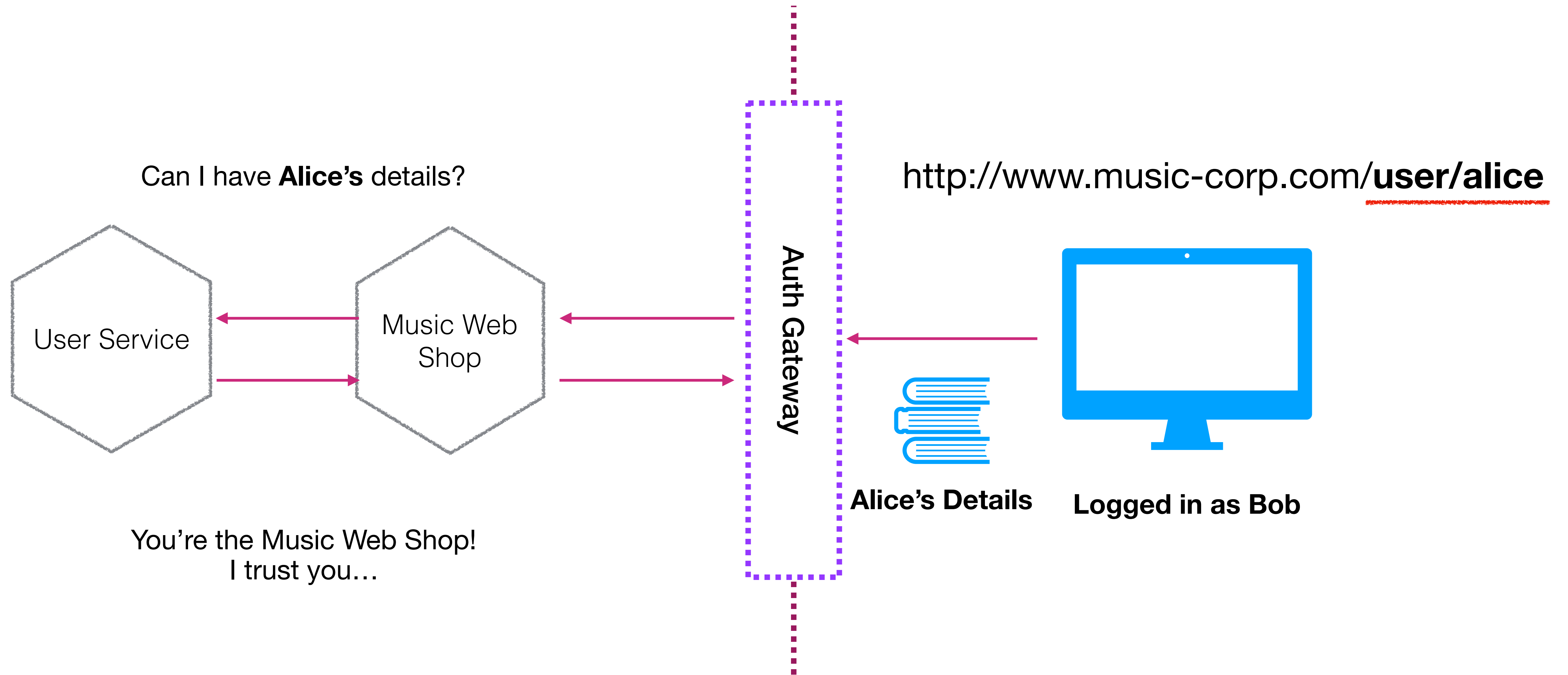

DOWNSTREAM AUTH - IMPLICIT TRUST?

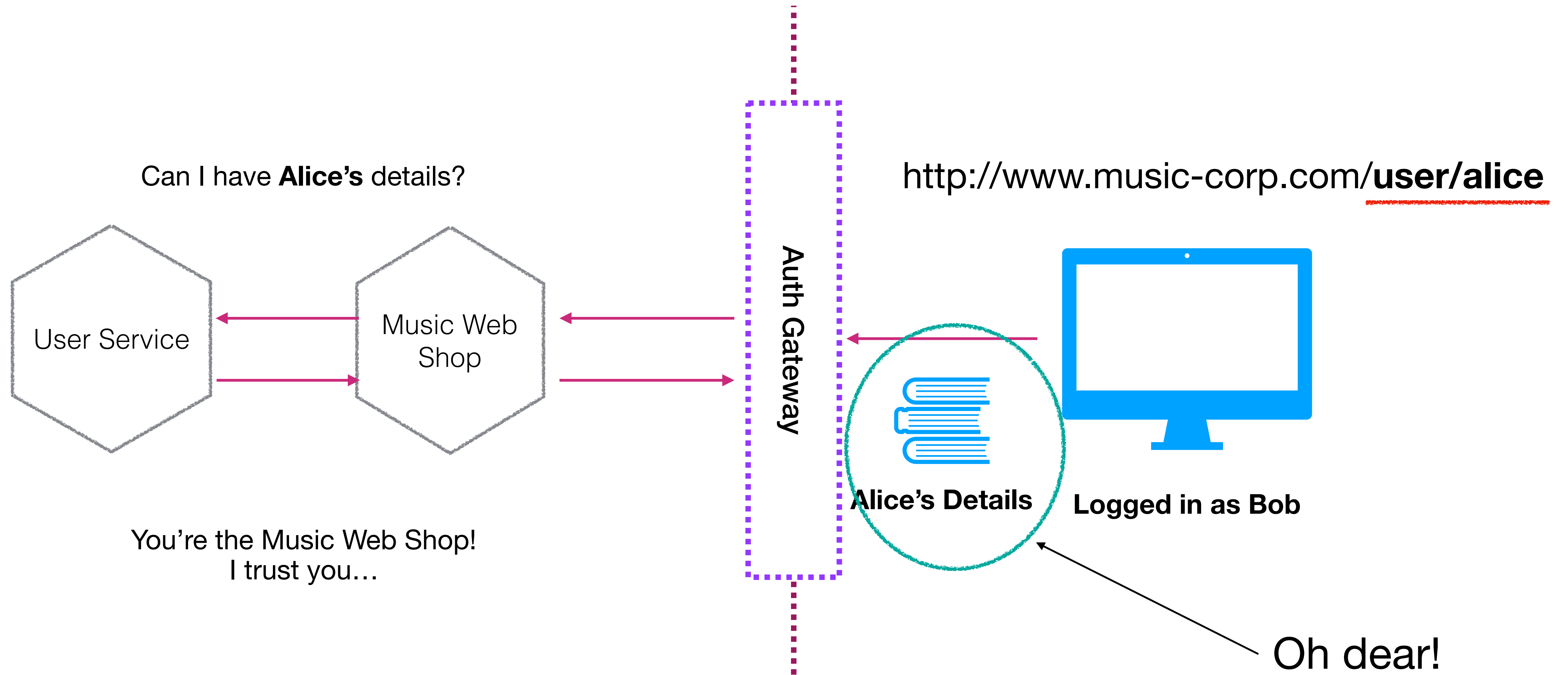

Confused
Deputy
Problem!



© 2014
Dave Lundy
lundyd@dma1.org

<https://www.flickr.com/photos/lundyd/14481829564>

AUTHORISE UPSTREAM?

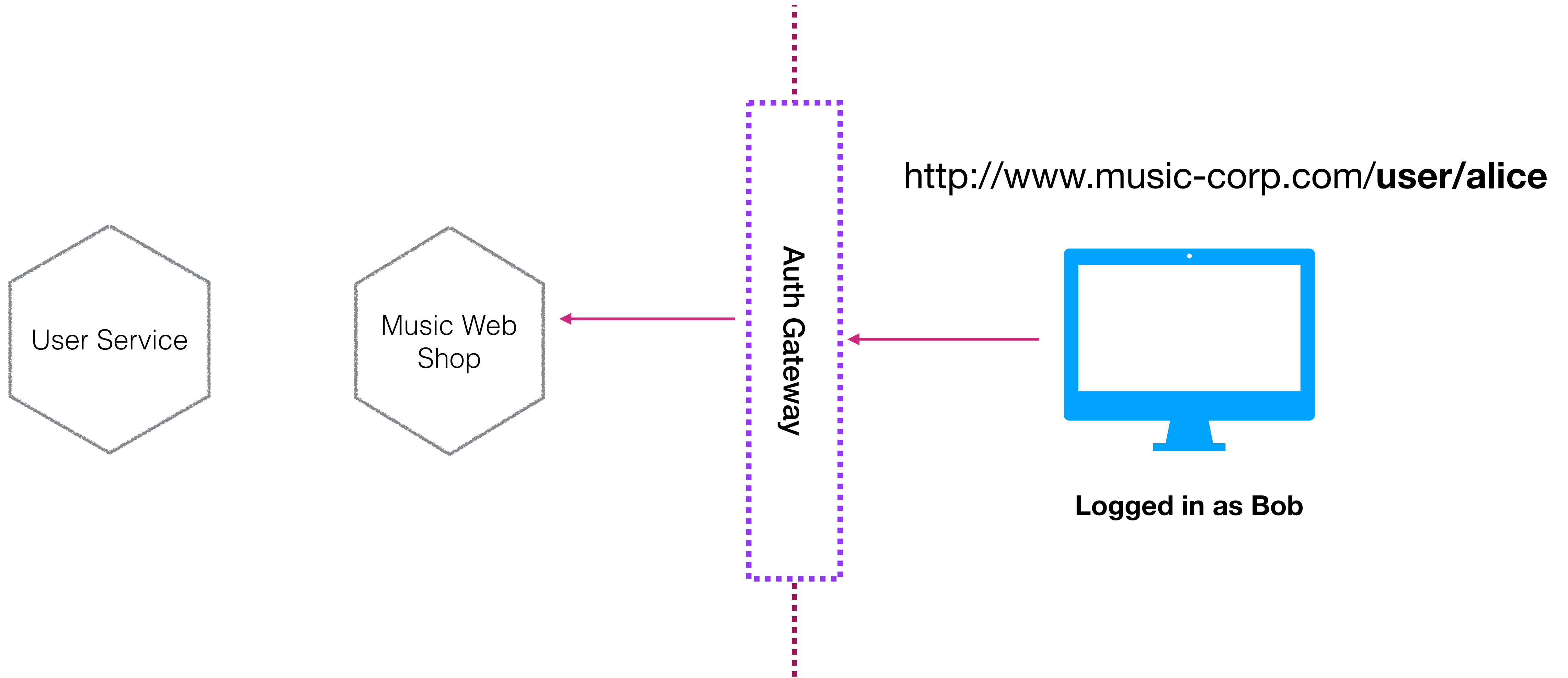

AUTHORISE UPSTREAM?

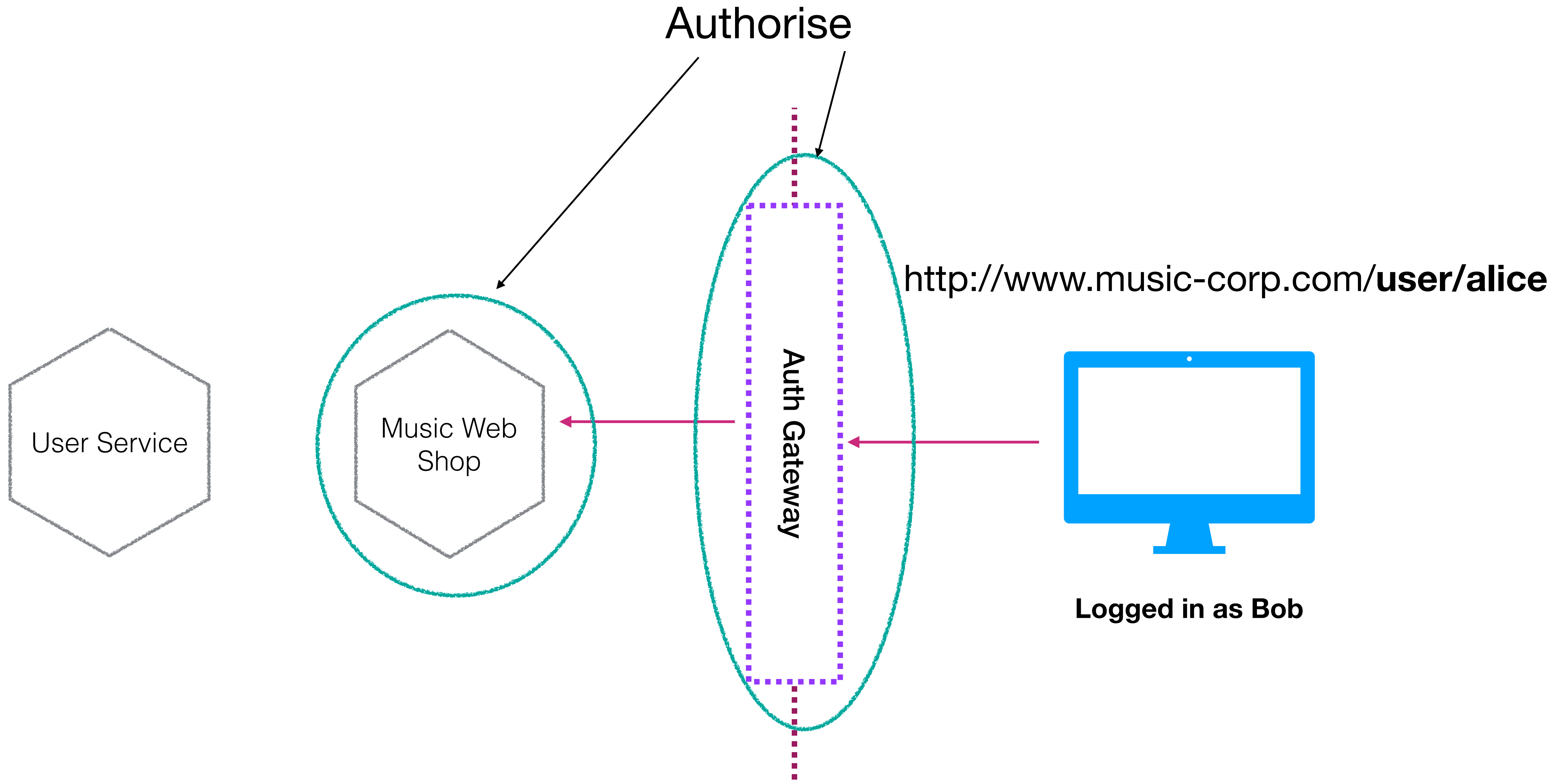

WHERE DO THE SMARTS LIVE?

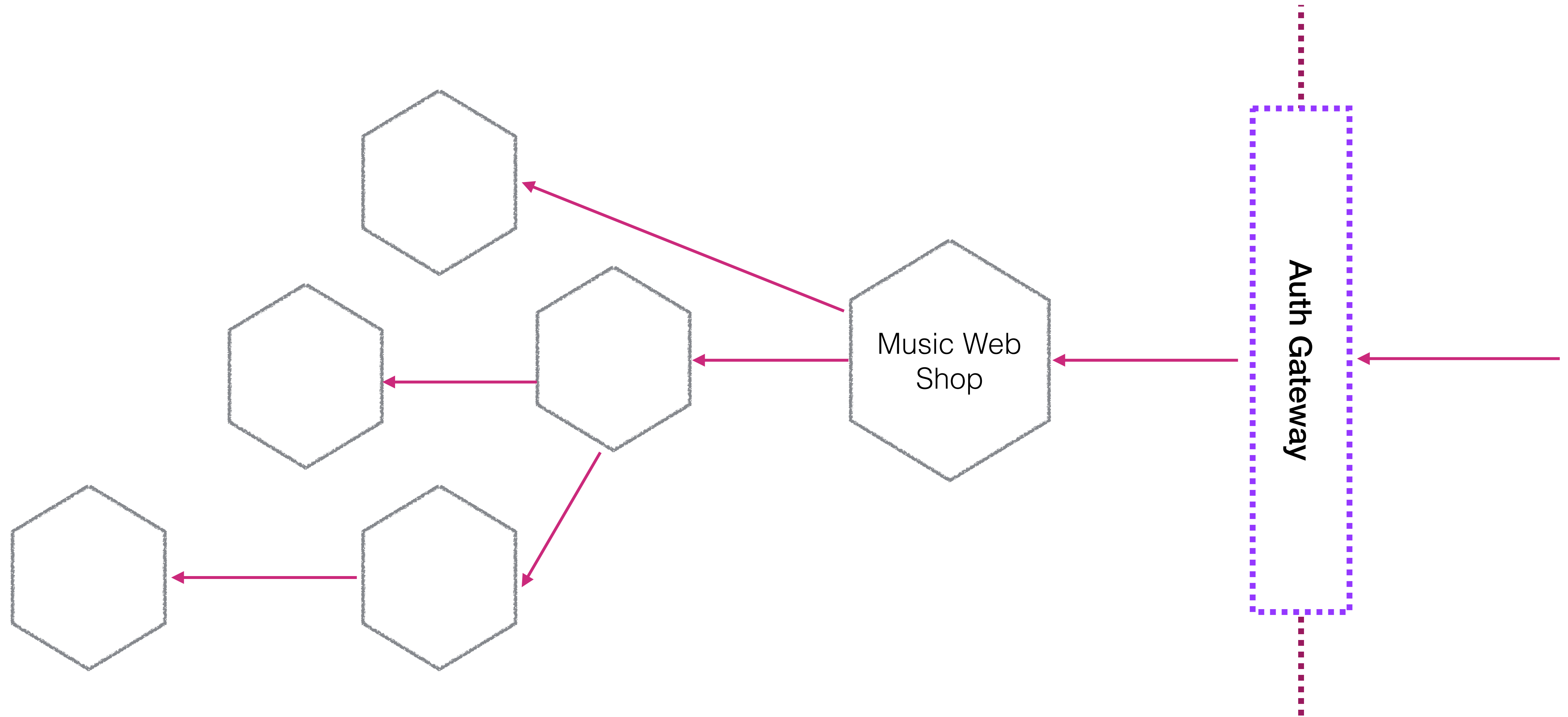

WHERE DO THE SMARTS LIVE?

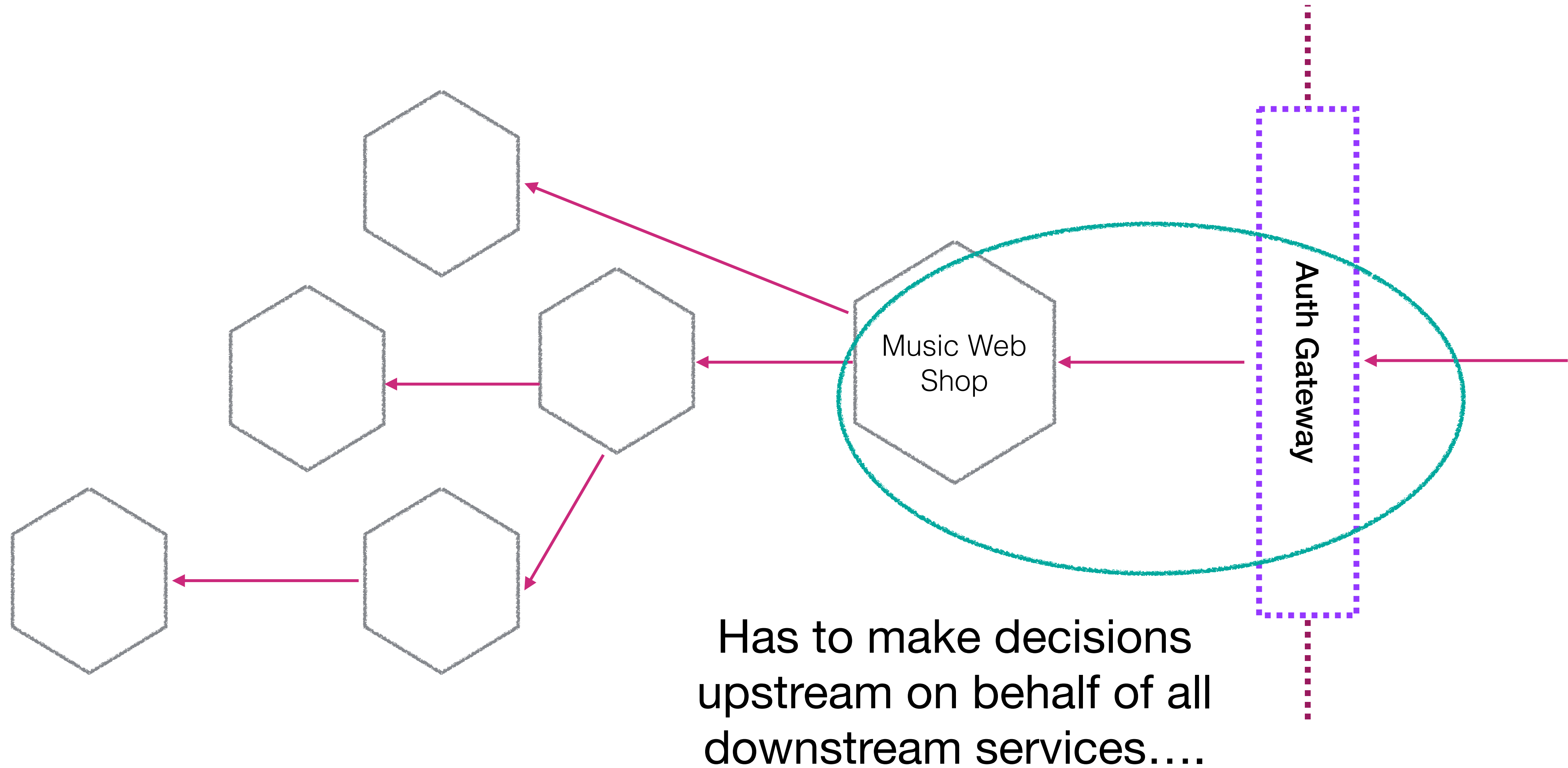

Has to make decisions upstream on behalf of all downstream services....

WHERE DO THE SMARTS LIVE?

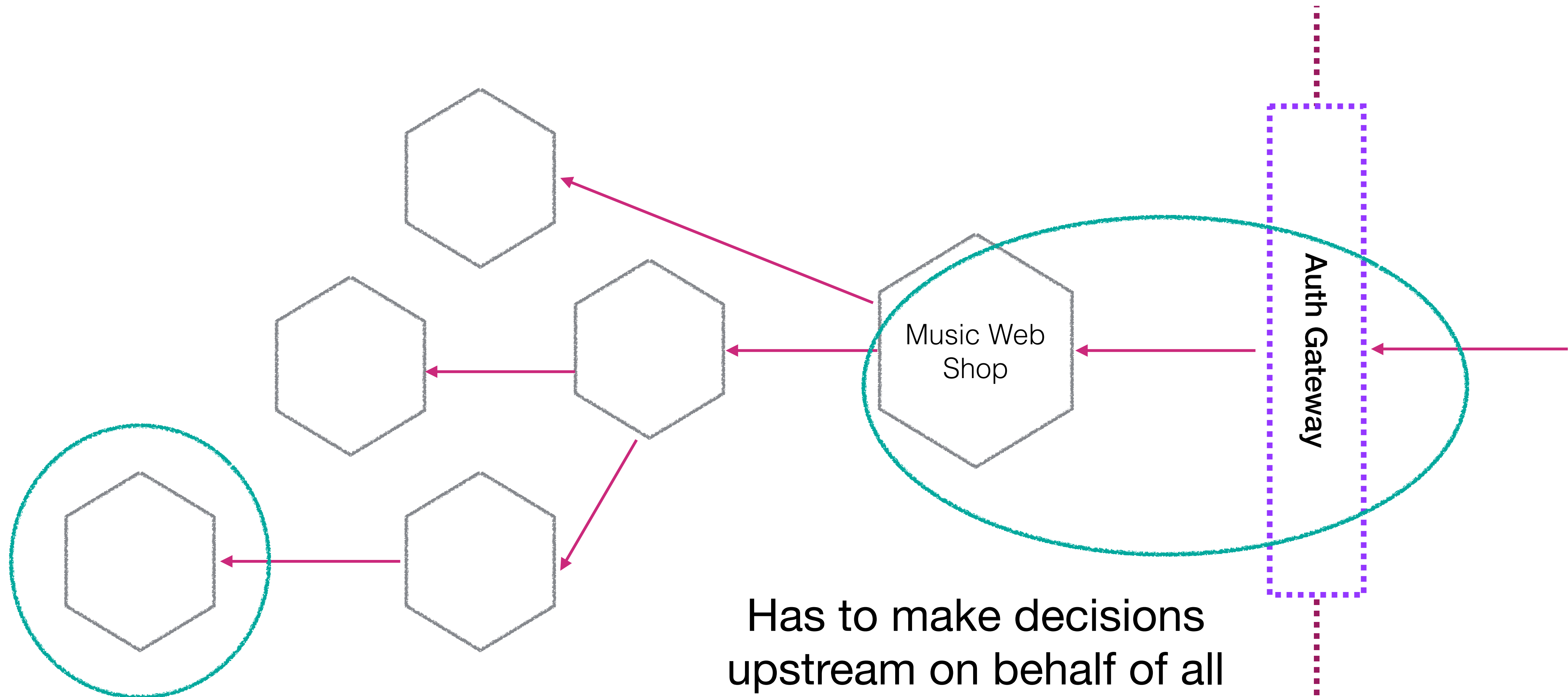

But it can be preferable to push this logic to the service itself

Has to make decisions upstream on behalf of all downstream services....

AUTHORISE DOWNSTREAM

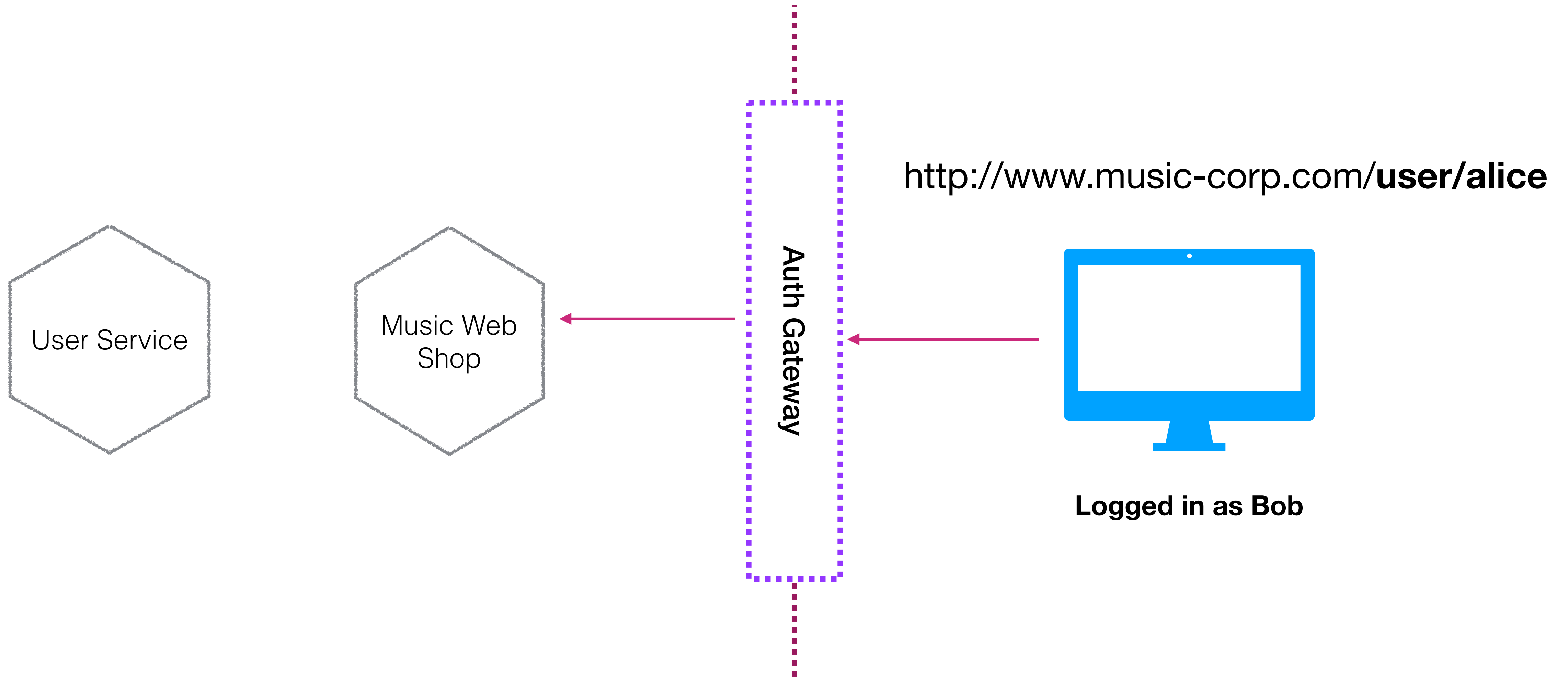

AUTHORISE DOWNSTREAM

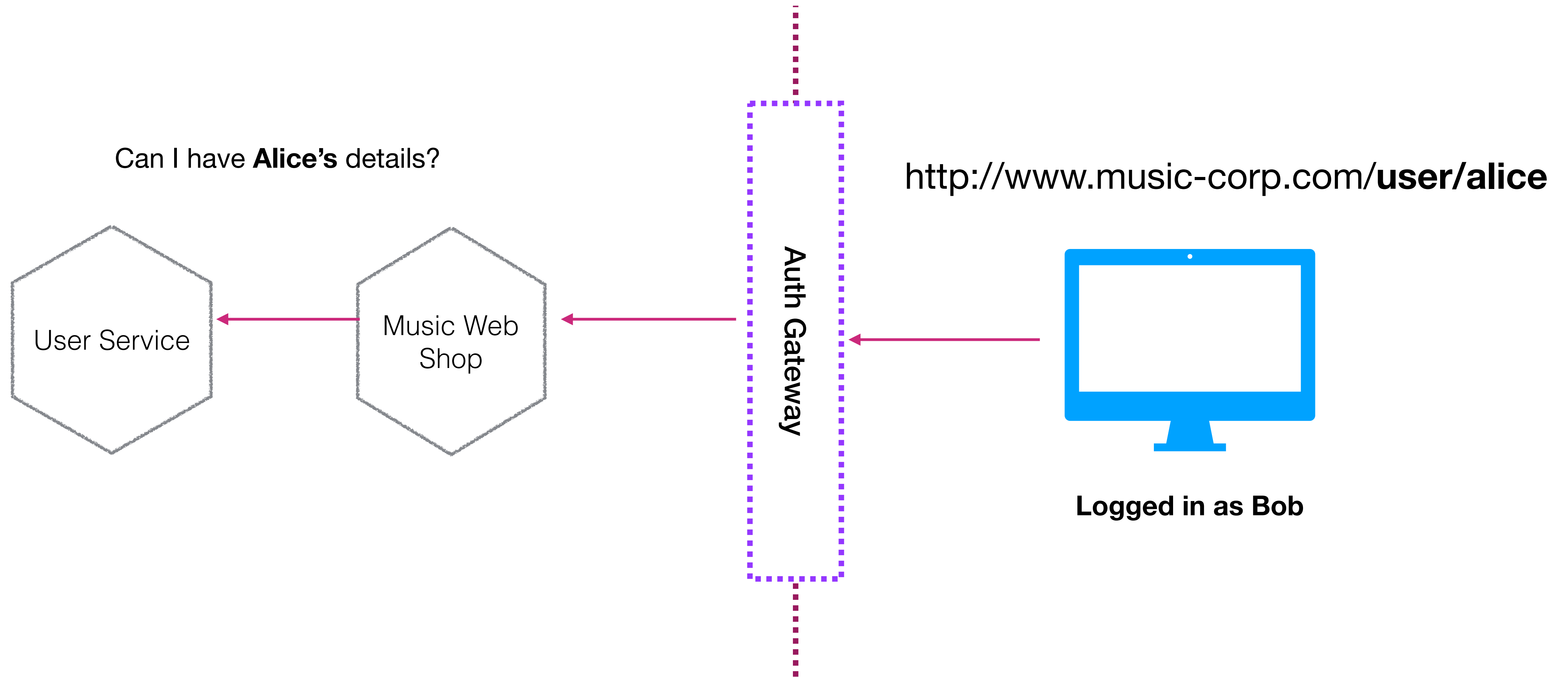

AUTHORISE DOWNSTREAM

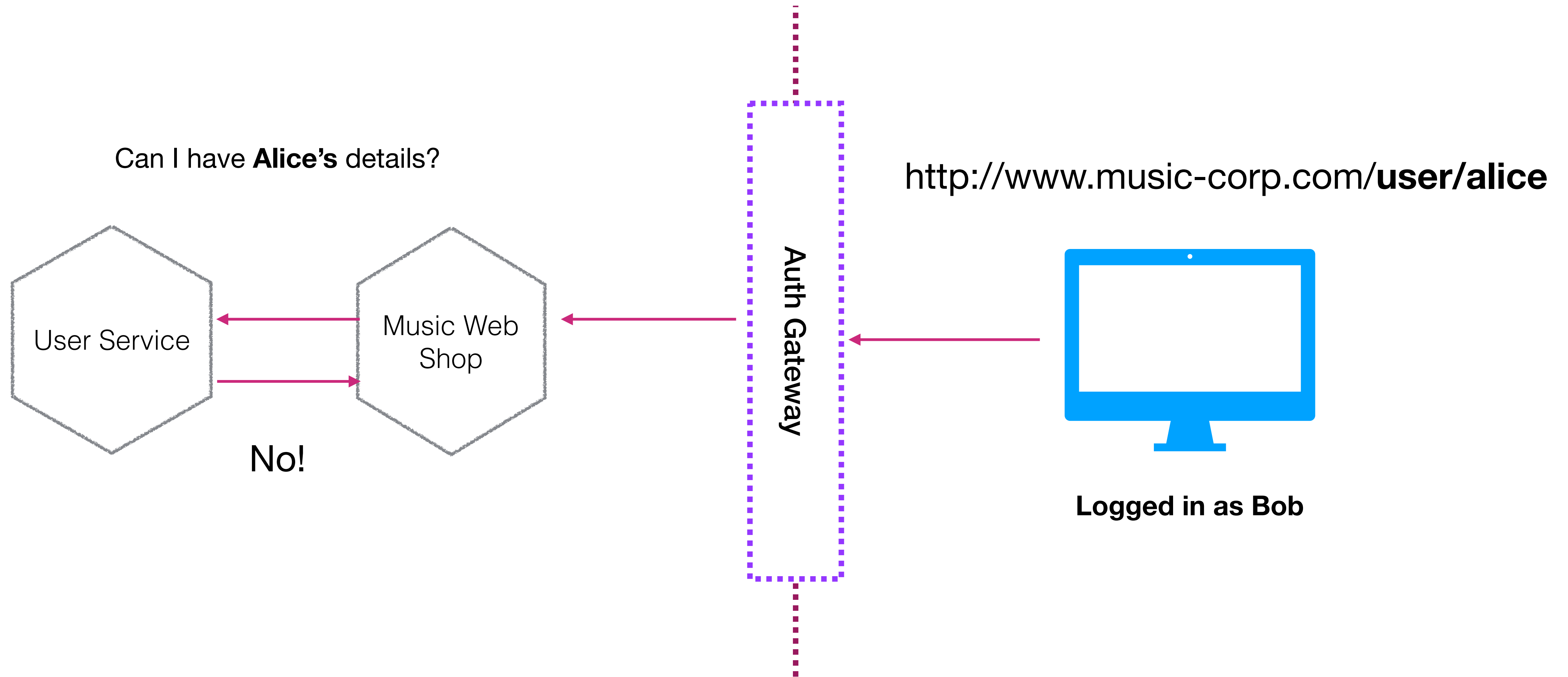

AUTHORISE DOWNSTREAM

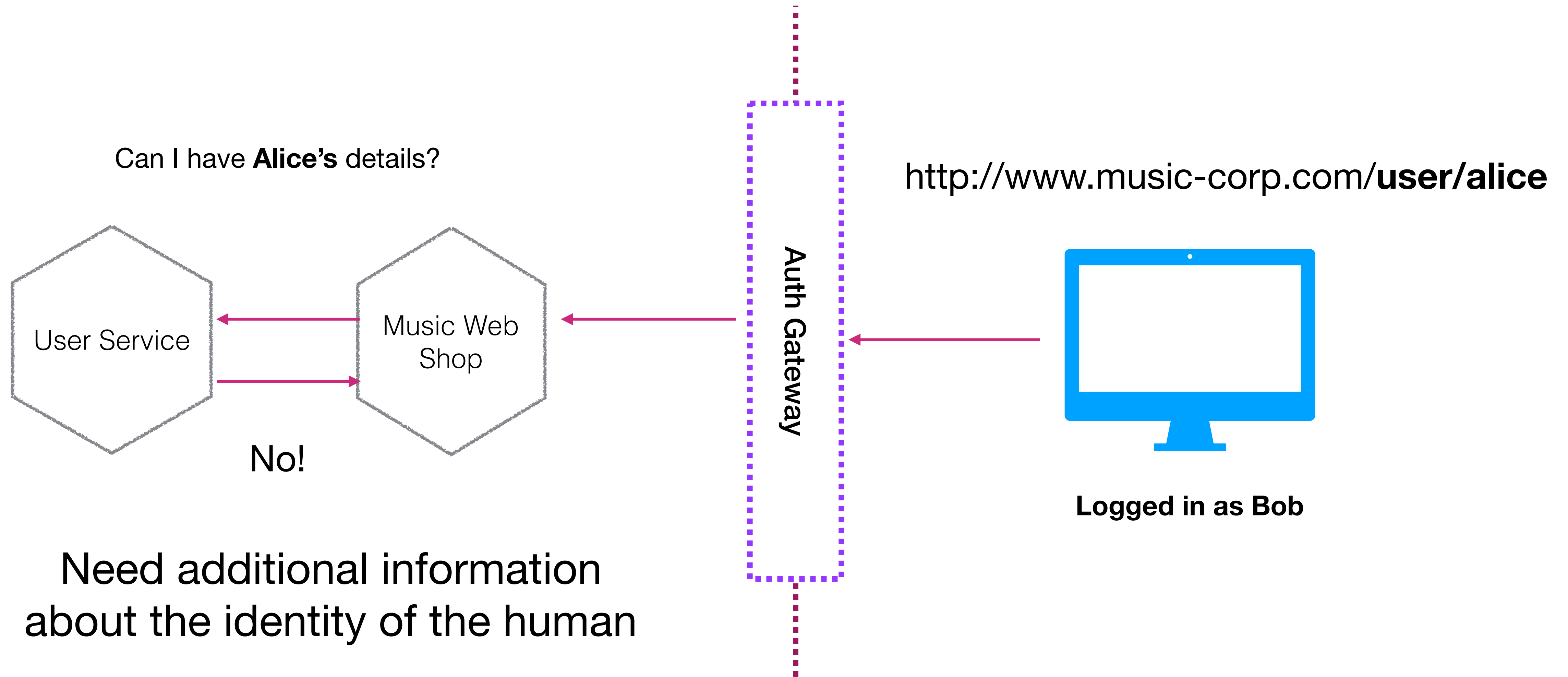

JWT

[Debugger](#) [Libraries](#) [Introduction](#) [Ask](#) [Get a T-shirt!](#)

Crafted by  Auth0



JSON Web Tokens are an open, industry standard **RFC 7519** method for representing claims securely between two parties.

JWT.IO allows you to decode, verify and generate JWT.

[LEARN MORE ABOUT JWT](#)

<https://jwt.io/>

```
{  
  "id": "402ndj39",  
  "name": "Alice Alison"  
}
```

```
{  
  "id": "402ndj39",  
  "name": "Alice Alison"  
}
```

eyJhbGciOiJIUzI1NiIsInR5cCI6IkpXVCJ9.

eyJzdWIiOiIxMjM0NTY3ODkwIiwibmFtZSI6IkpvaG4

gRG9IiwiaXNTb2NpYWwiOiJ1bnRydWV9.

4pcPyMD09o1PSyXnrXCjTwXyr4Bsezdi1AVTmud2fU4

USING JWT TOKENS

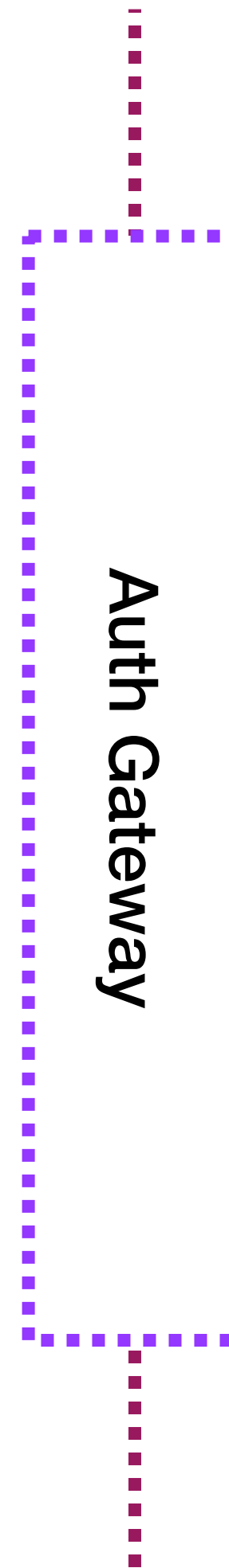
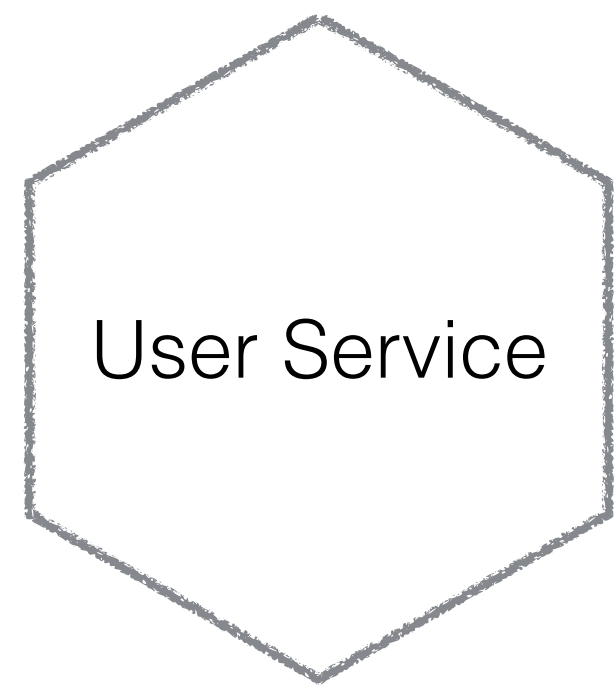

<http://www.music-corp.com/user/alice>



Logged in as Bob

USING JWT TOKENS

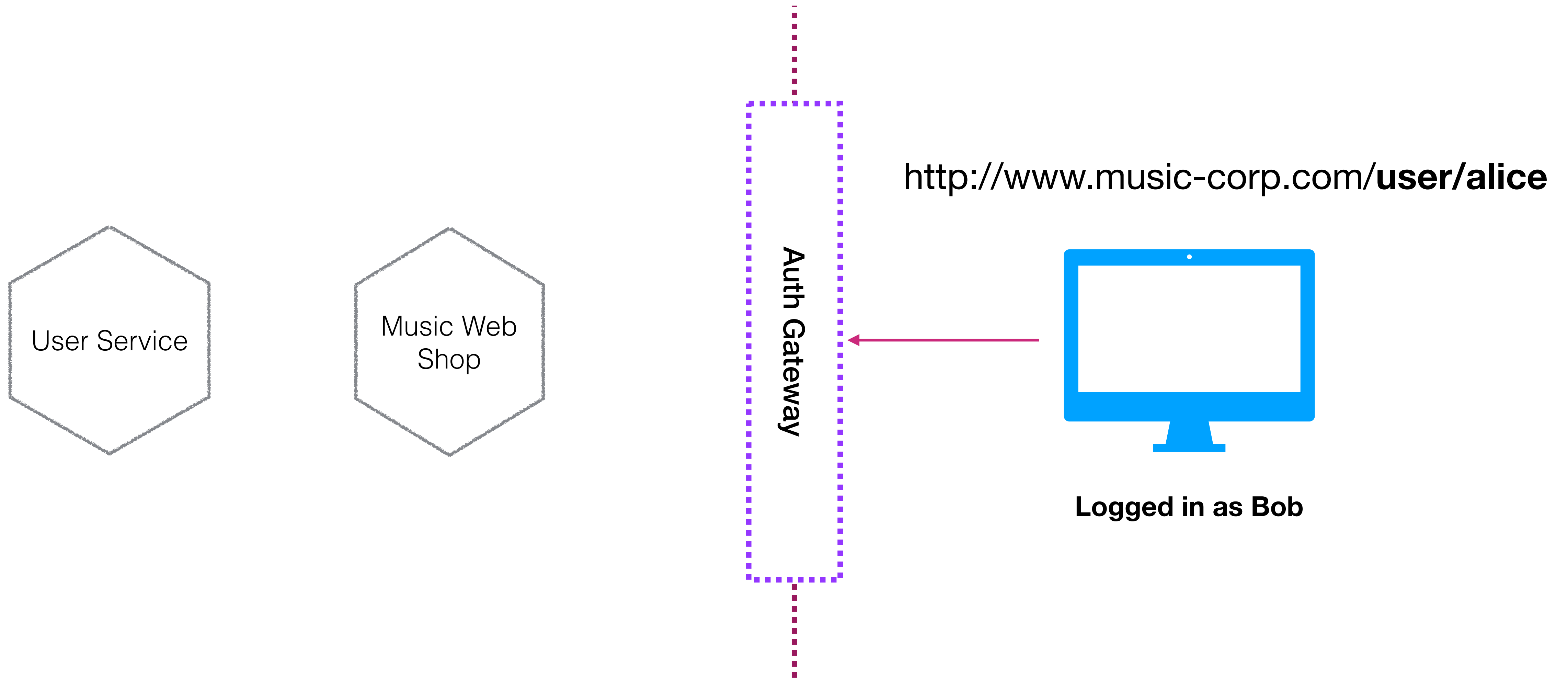

USING JWT TOKENS

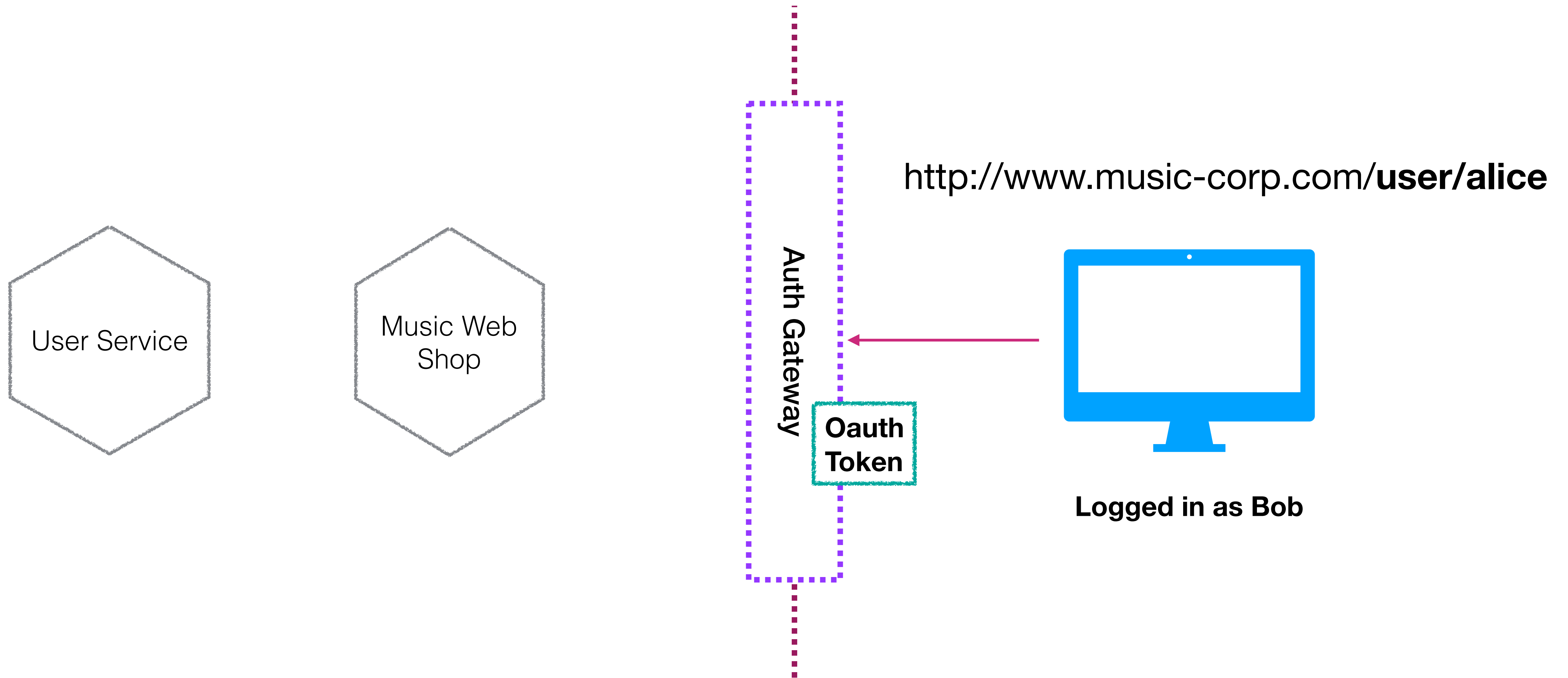

USING JWT TOKENS

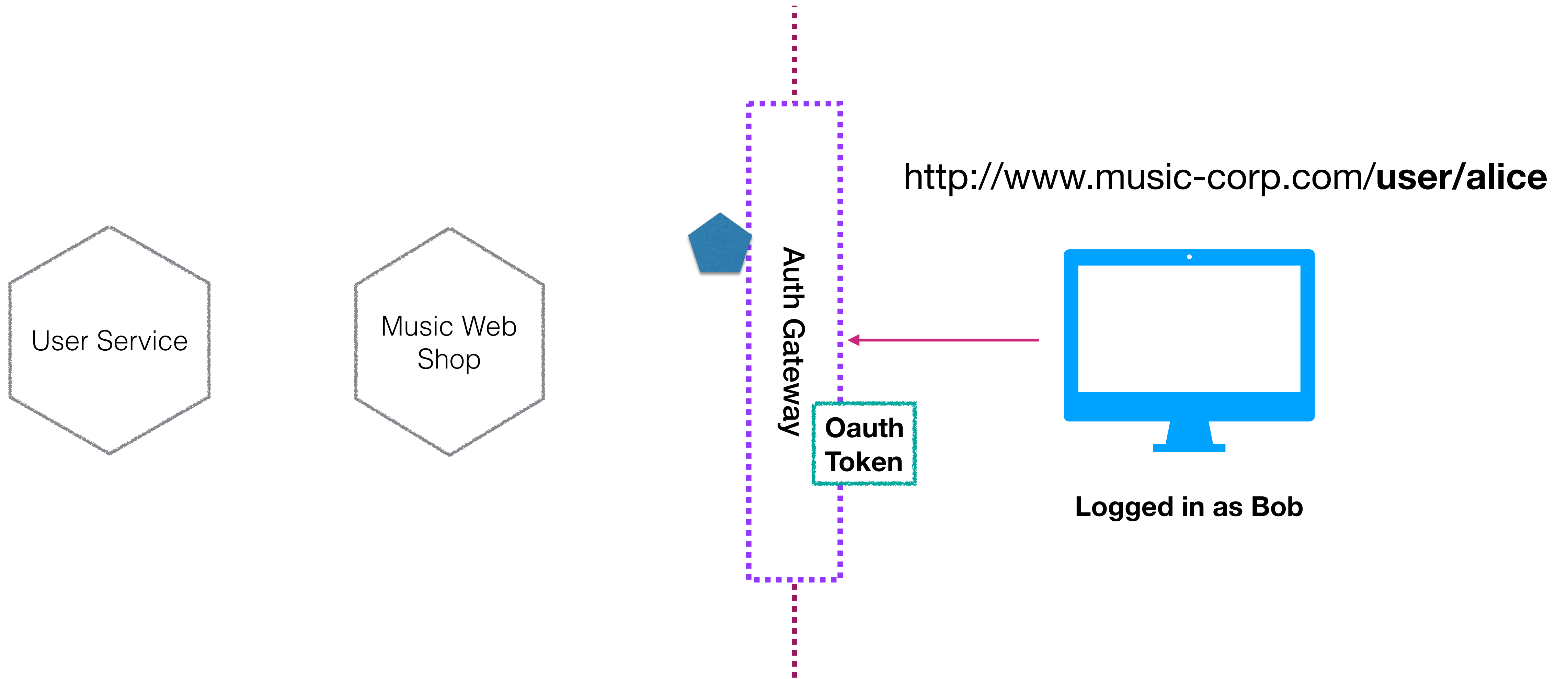

USING JWT TOKENS

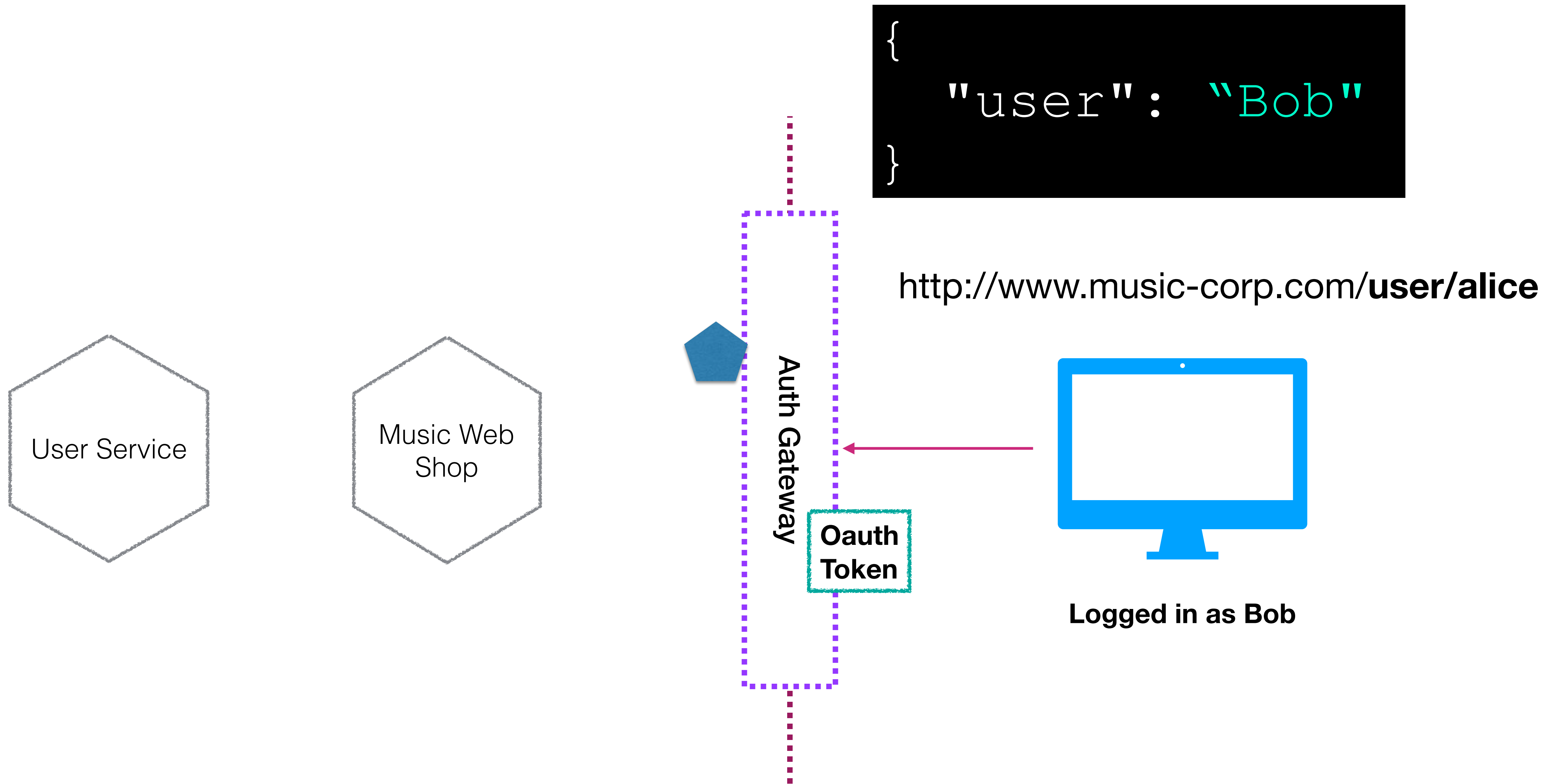

USING JWT TOKENS

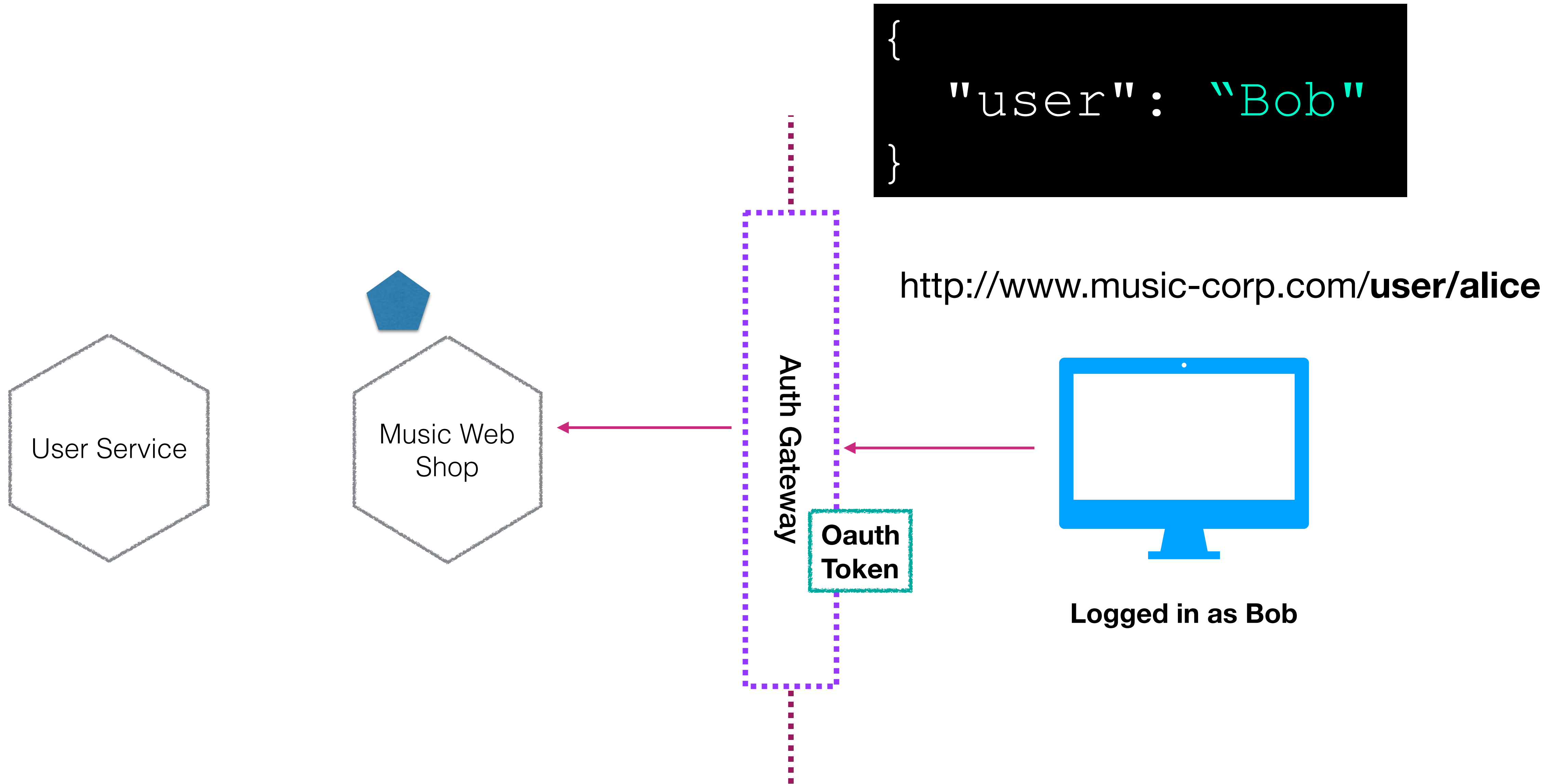

USING JWT TOKENS

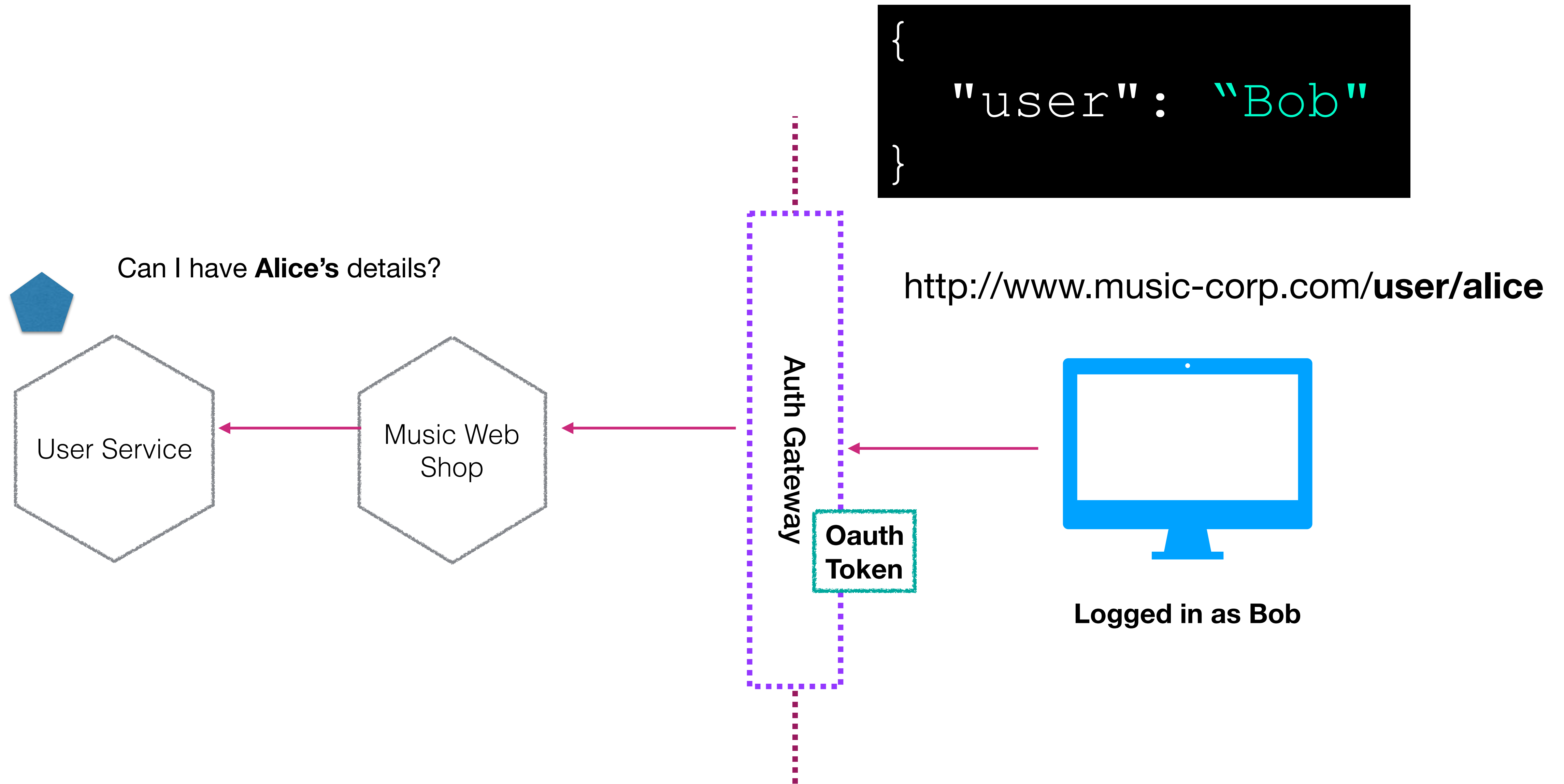

USING JWT TOKENS

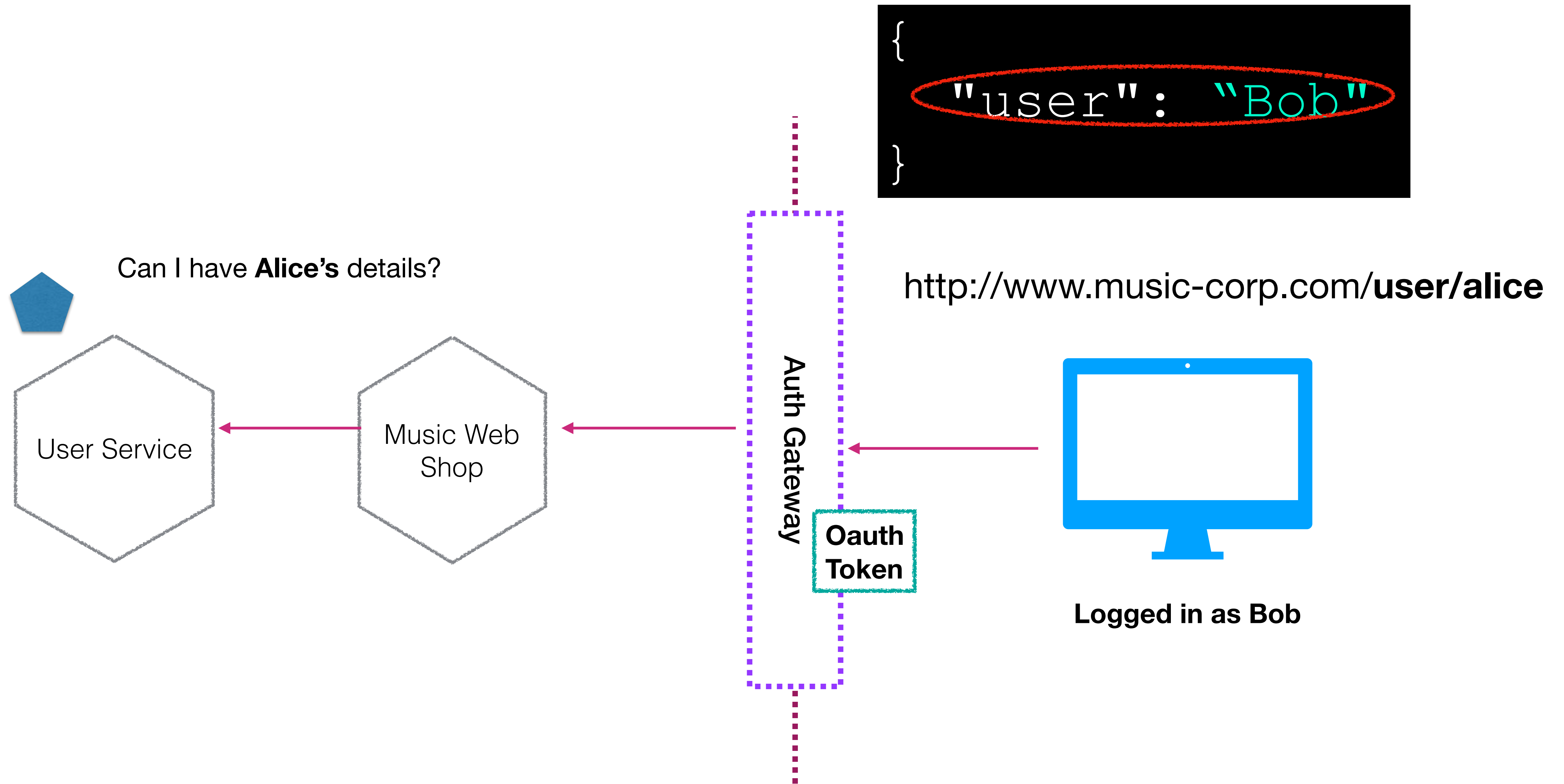

USING JWT TOKENS

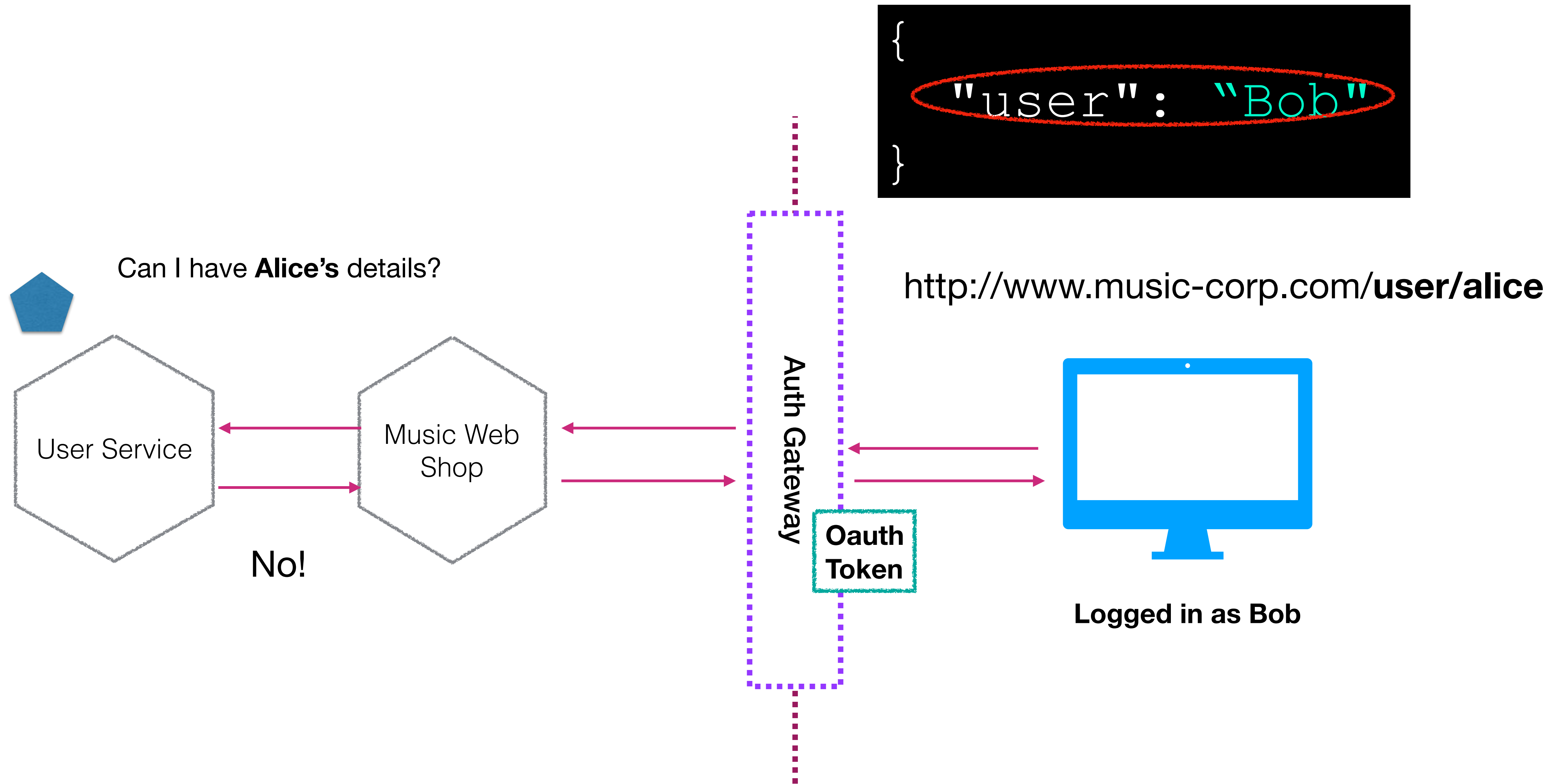

USING JWT TOKENS

Token can be validated in the user service

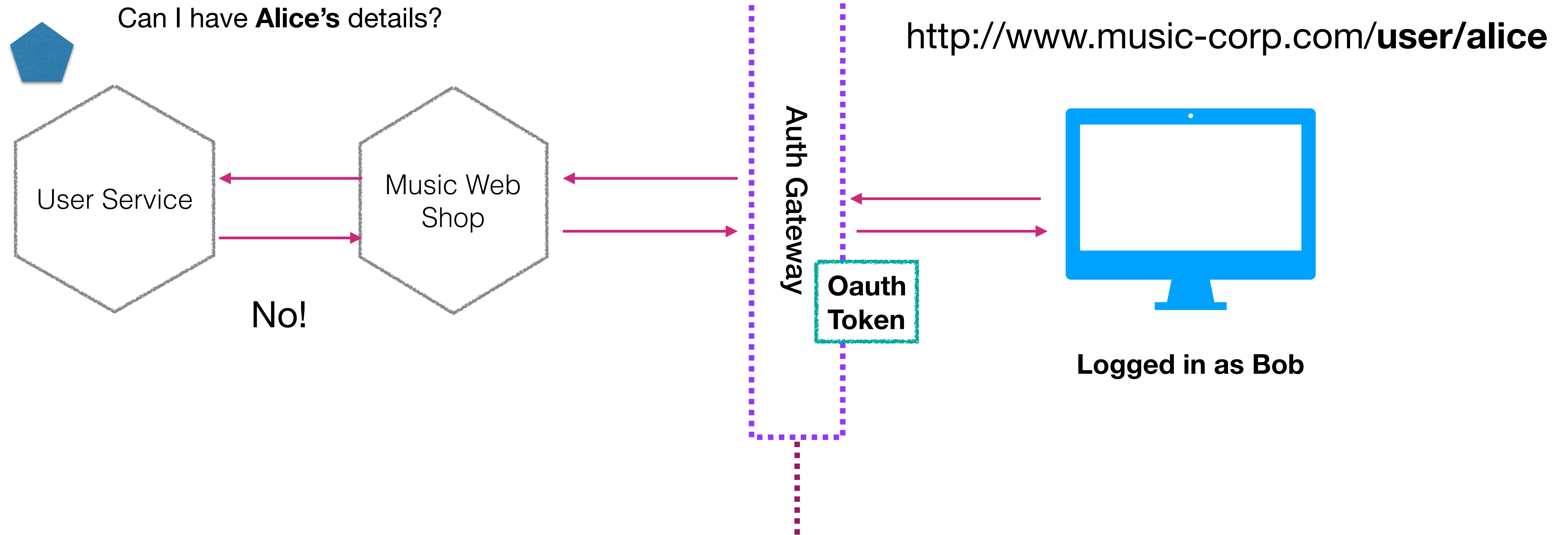

USING JWT TOKENS

Token can be validated in the user service

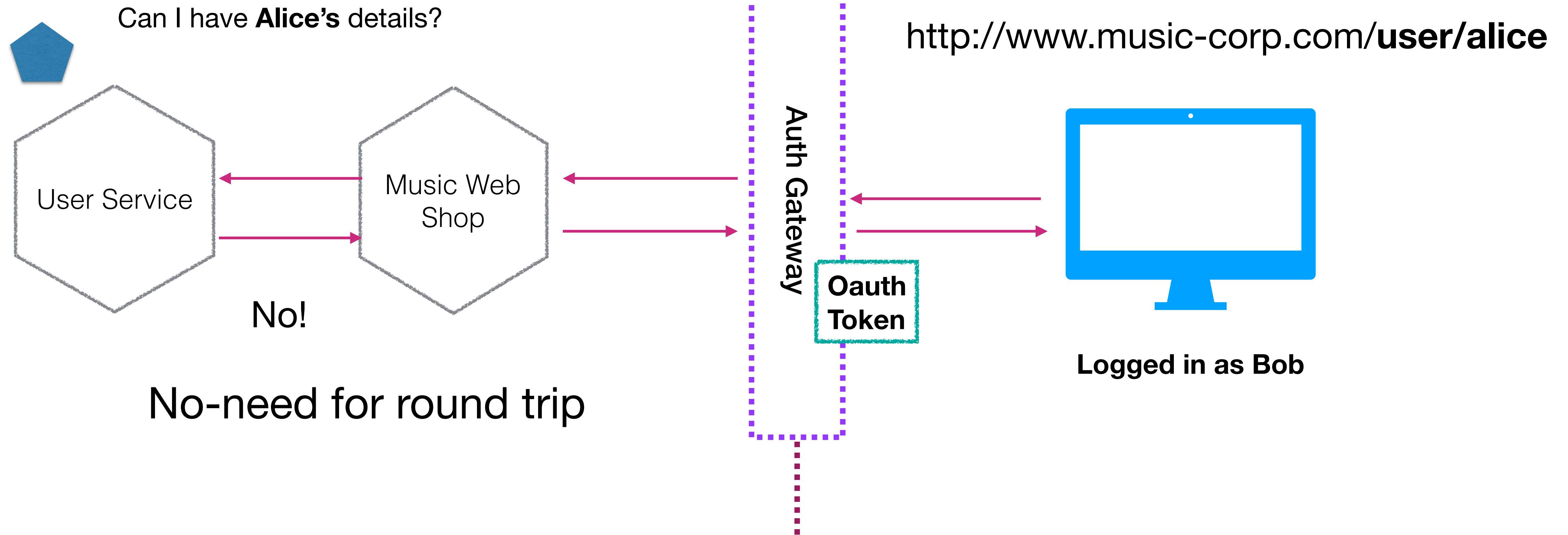

No-need for round trip

SERVICE MESHES



Linkerd

<https://linkerd.io>

SERVICE MESHES



Linkerd

<https://linkerd.io>



Istio

<https://istio.io>

COMMON CONNECTION CONCERNS

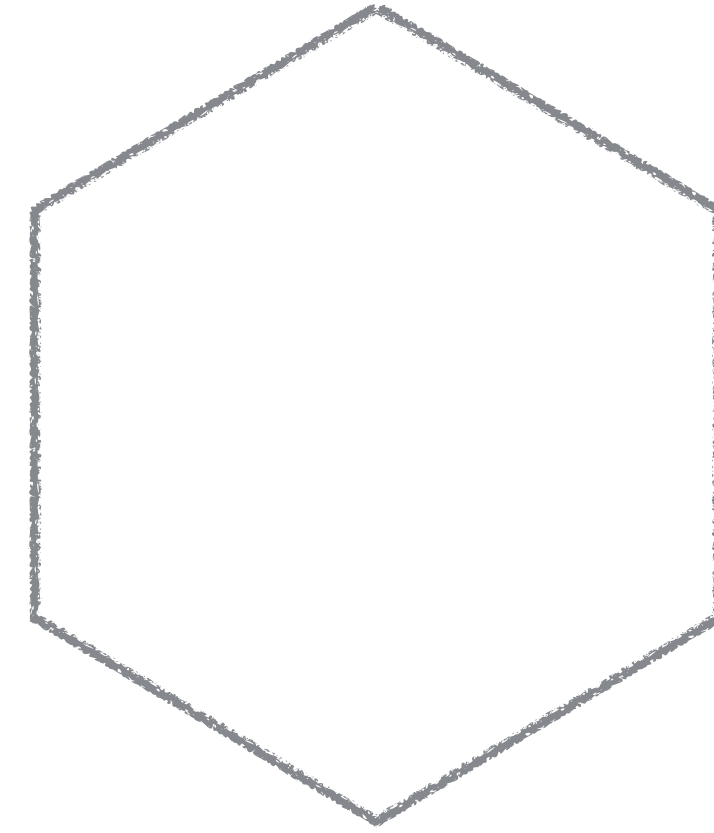
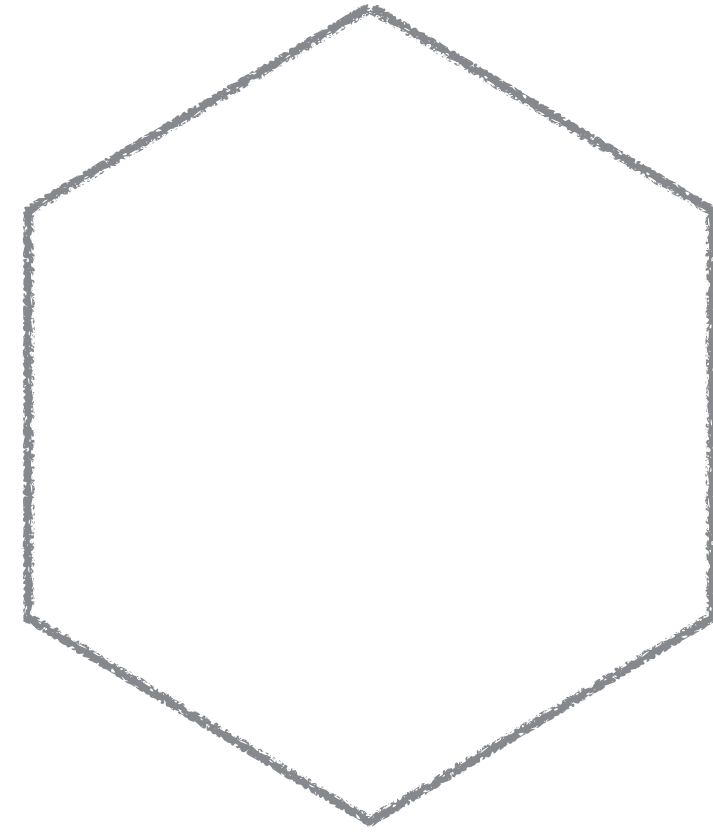

COMMON CONNECTION CONCERNS

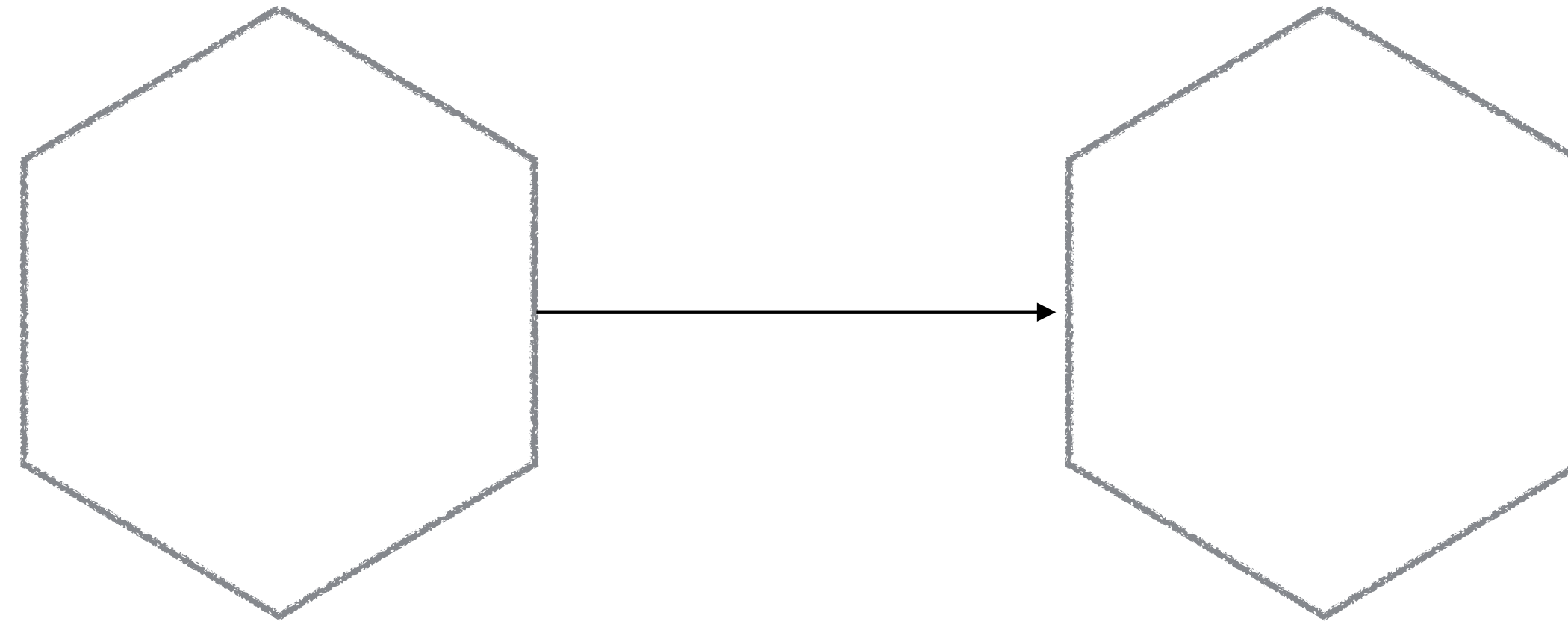

COMMON CONNECTION CONCERNS

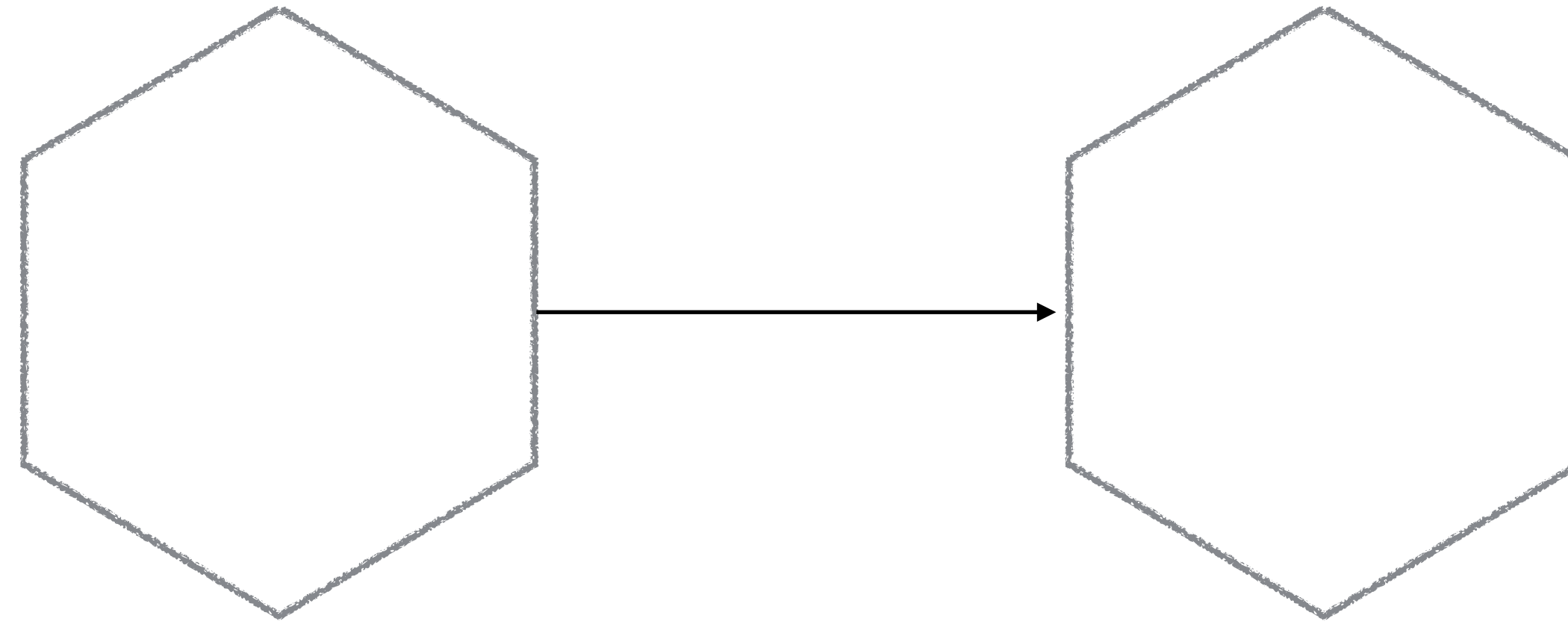

Tracing

COMMON CONNECTION CONCERNS

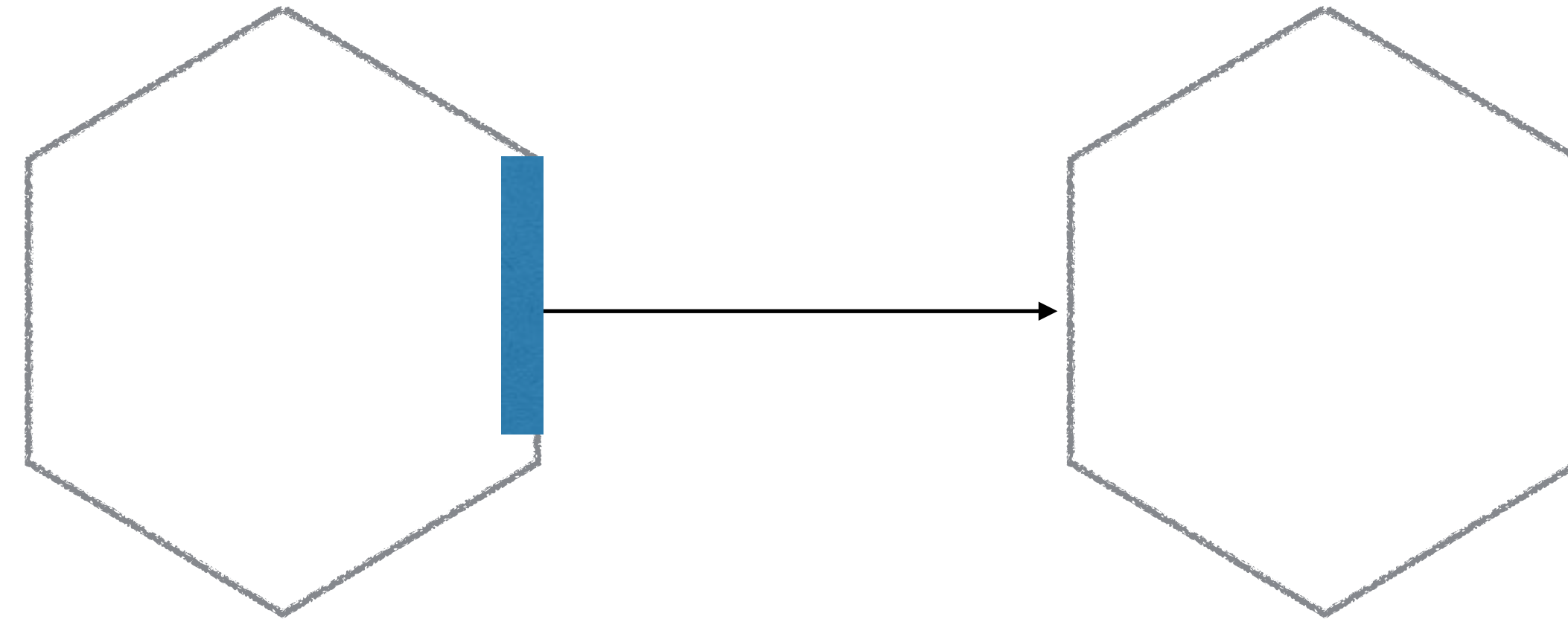

Tracing

COMMON CONNECTION CONCERNS

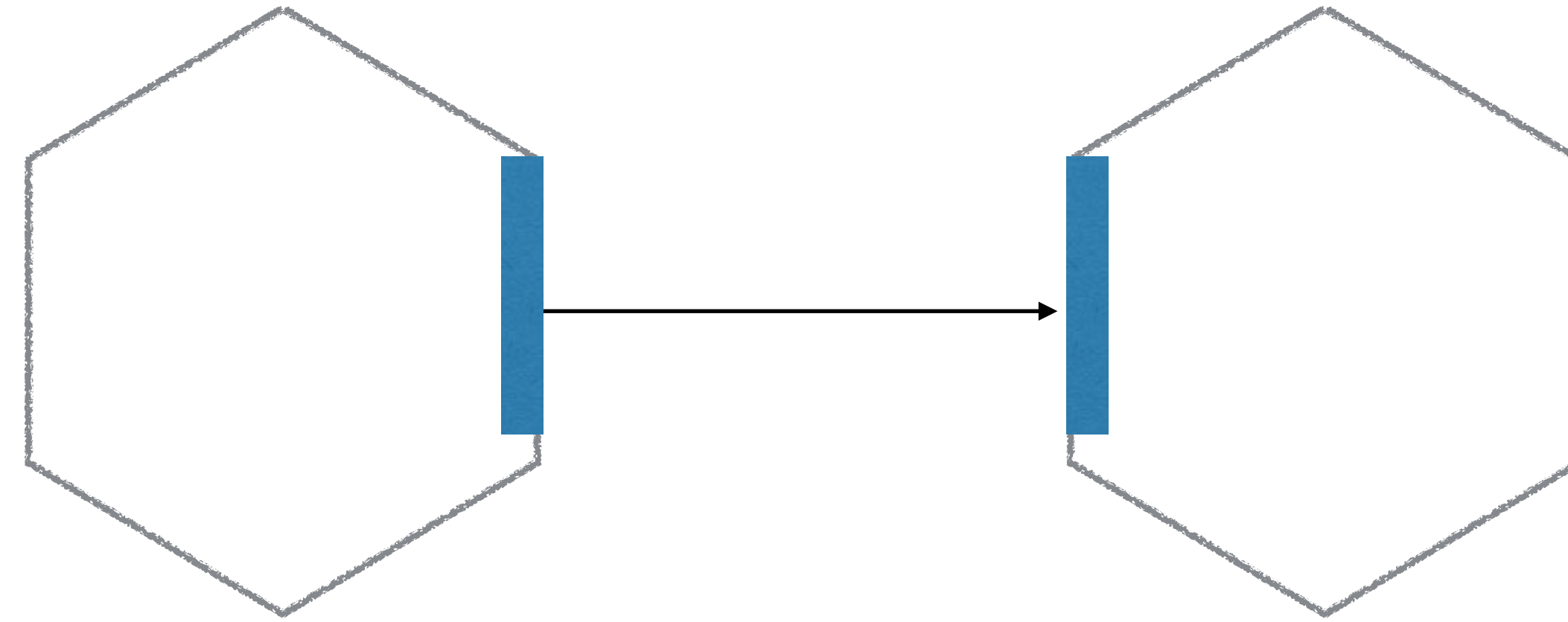

Tracing

COMMON CONNECTION CONCERNS

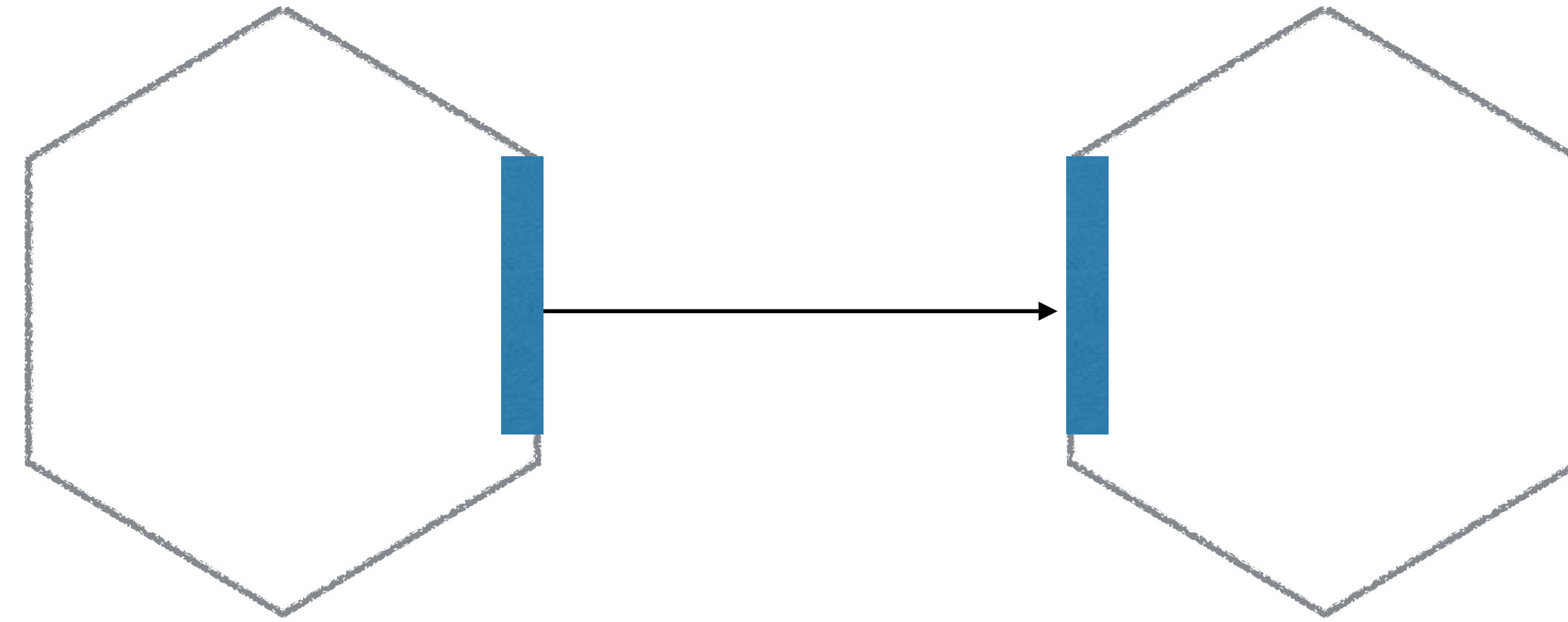

Tracing

Load Balancing & Service Discovery

COMMON CONNECTION CONCERNS

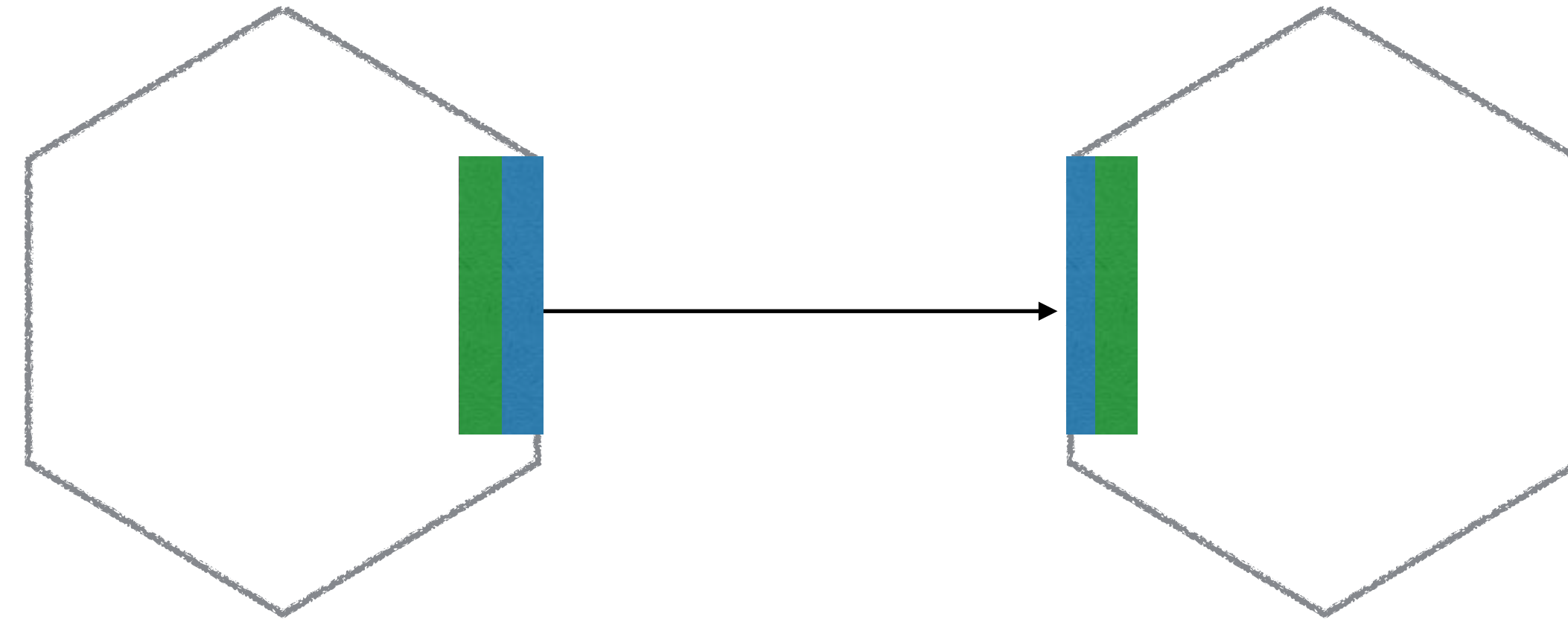

Tracing

Load Balancing & Service Discovery

COMMON CONNECTION CONCERNS

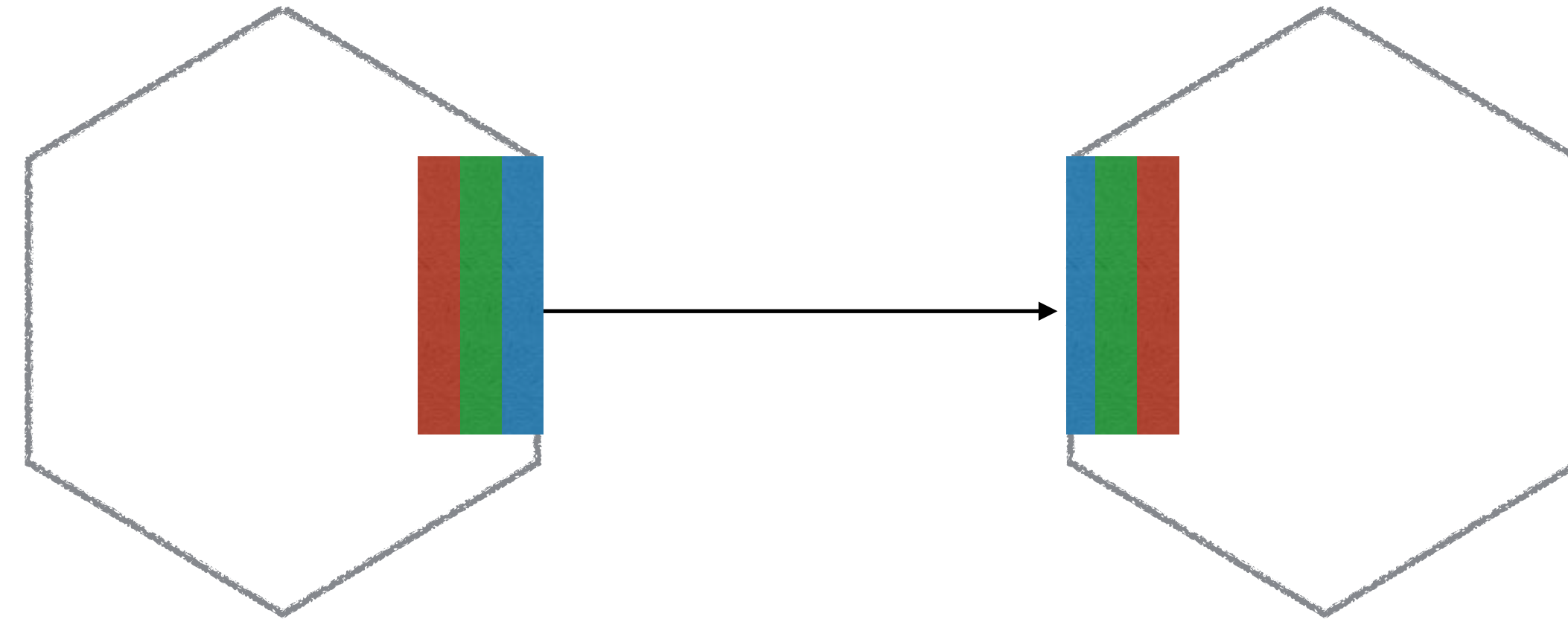

Tracing

Load Balancing & Service Discovery

Authorisation & Authentication

COMMON CONNECTION CONCERNS

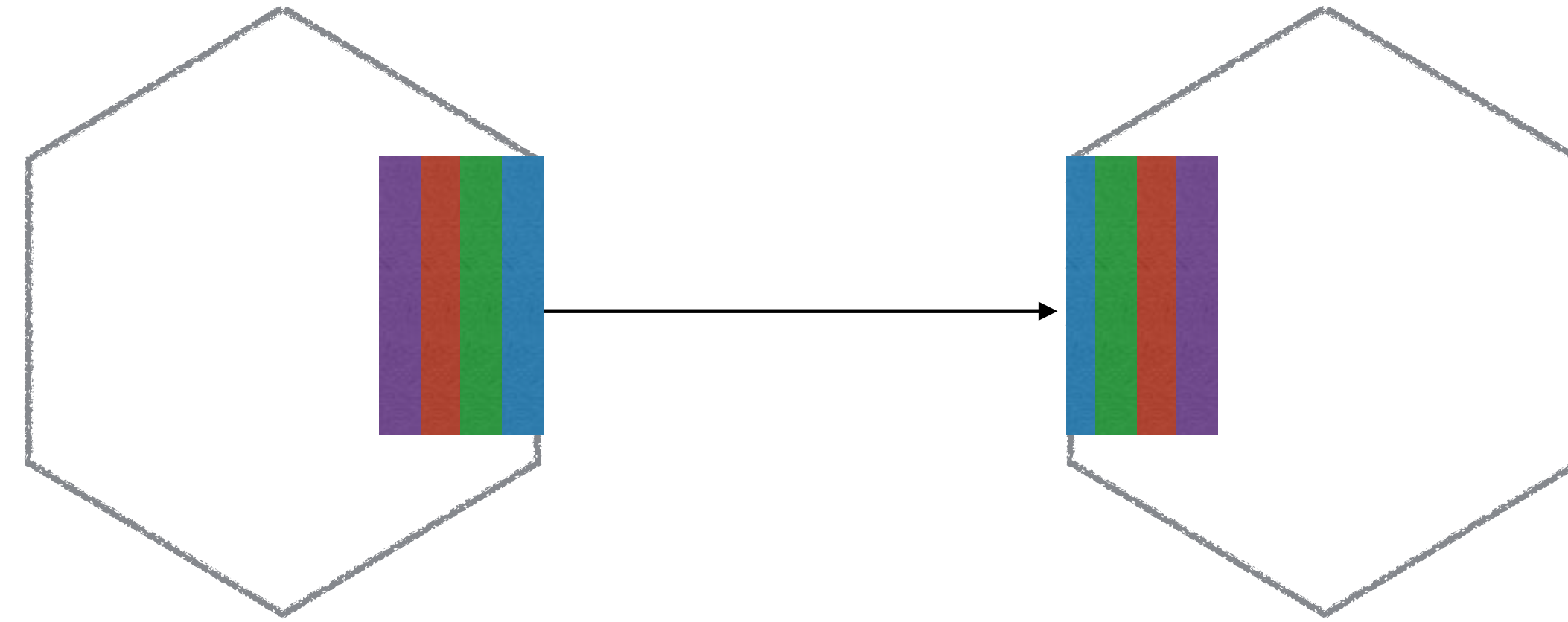

Tracing

Load Balancing & Service Discovery

Authorisation & Authentication

Connection Resilience & Retry

COMMON MICROSERVICE FRAMEWORKS



POLYGLOT?

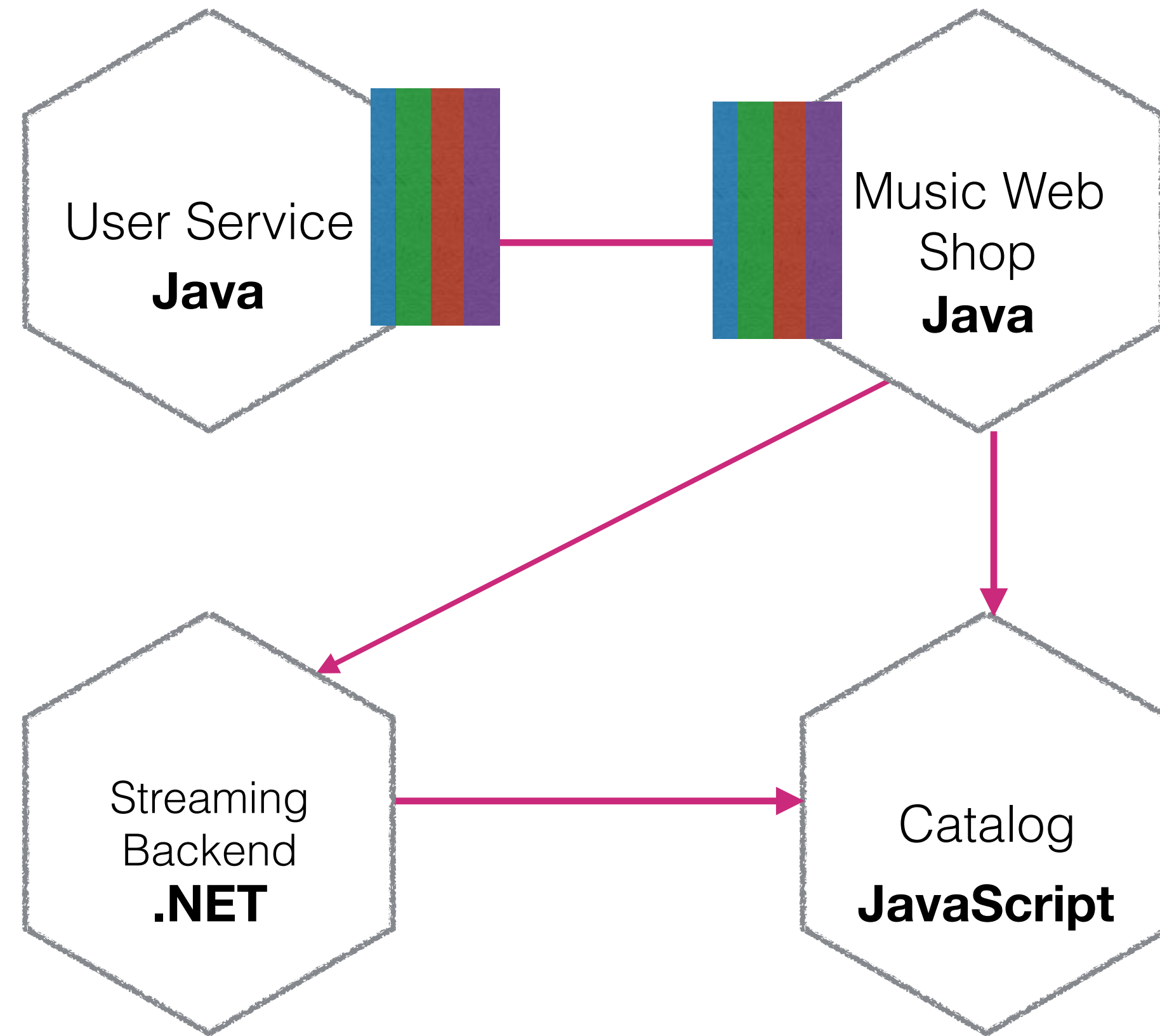

POLYGLOT?

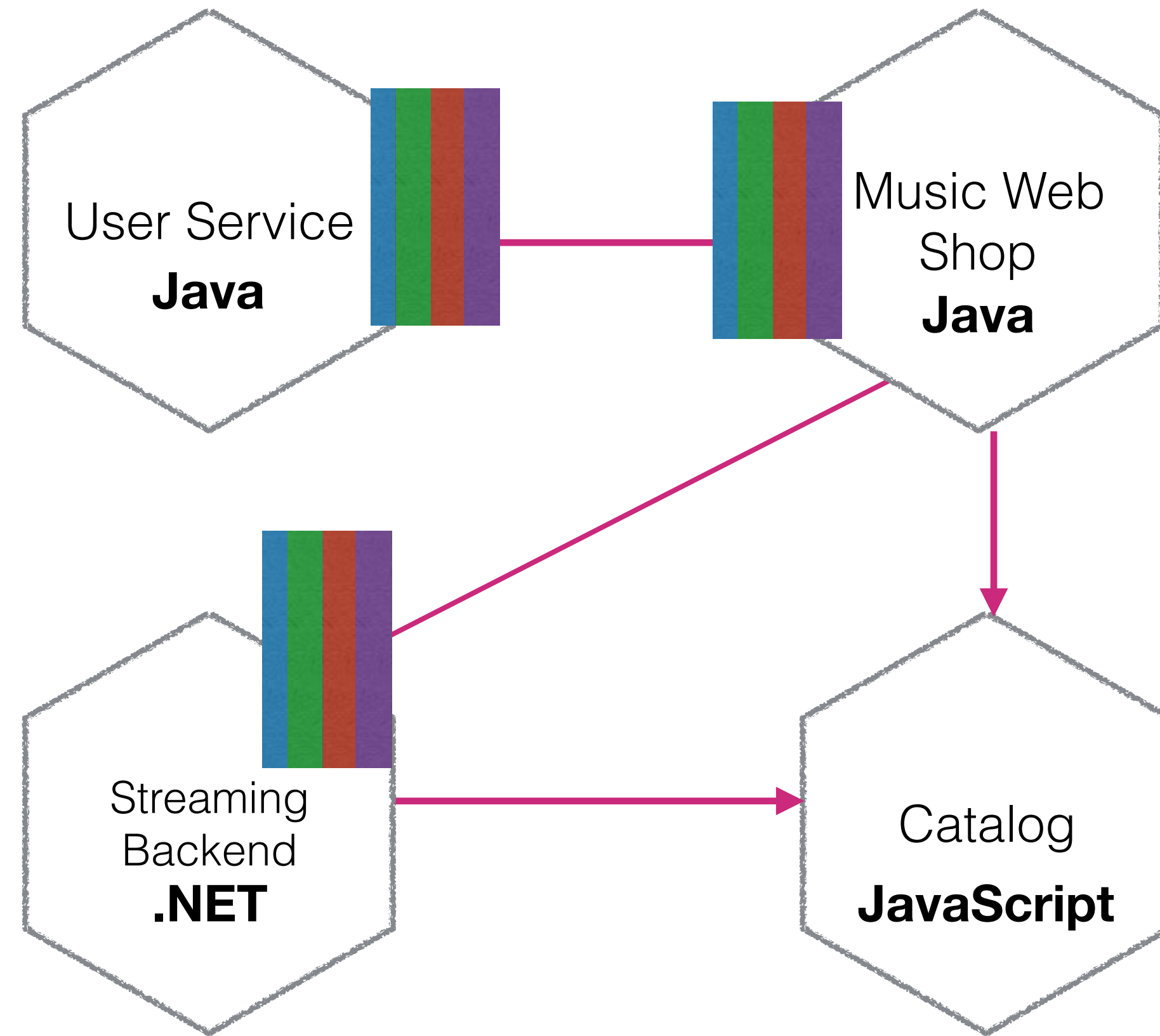

POLYGLOT?

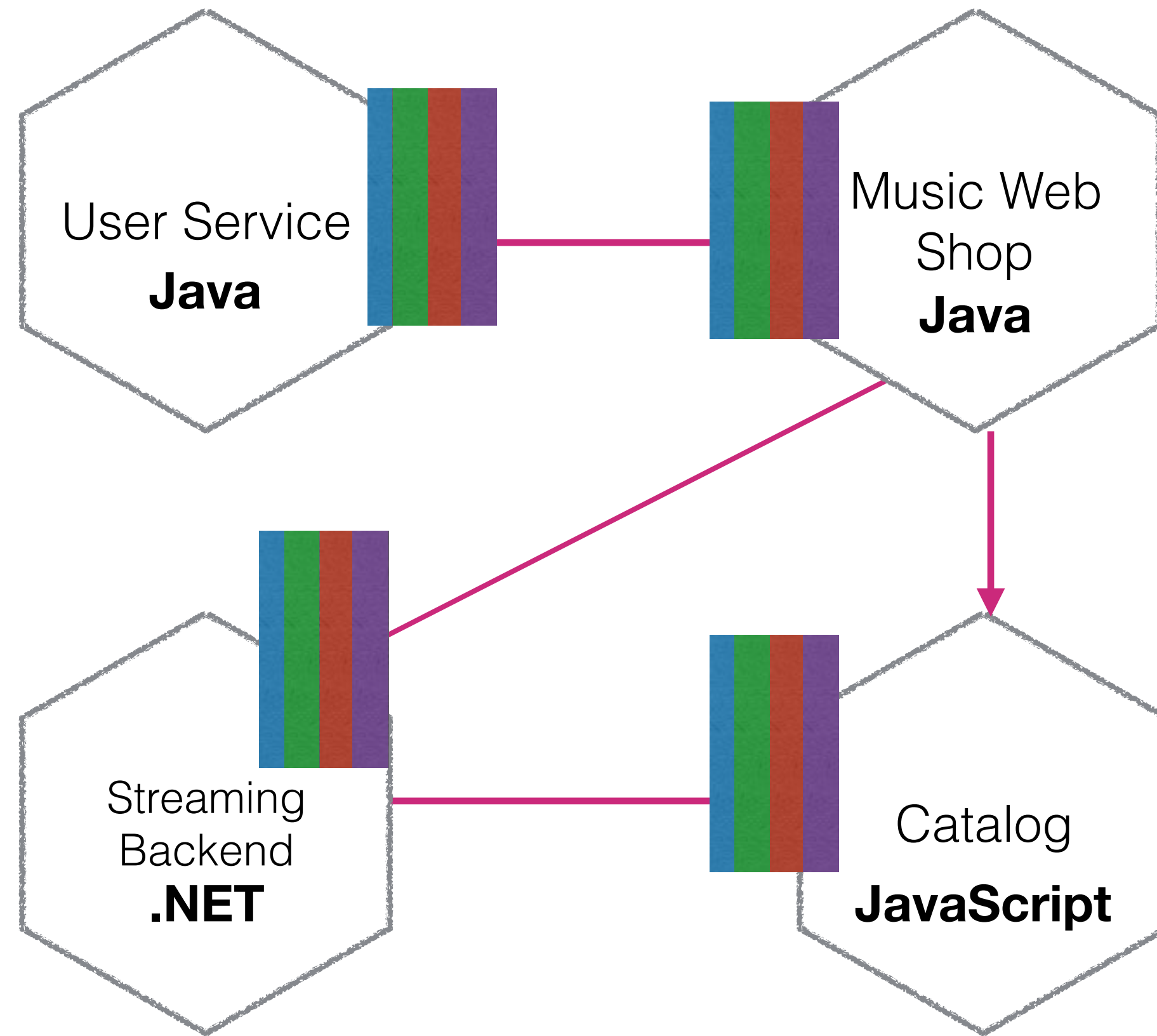

VERSION DRIFT

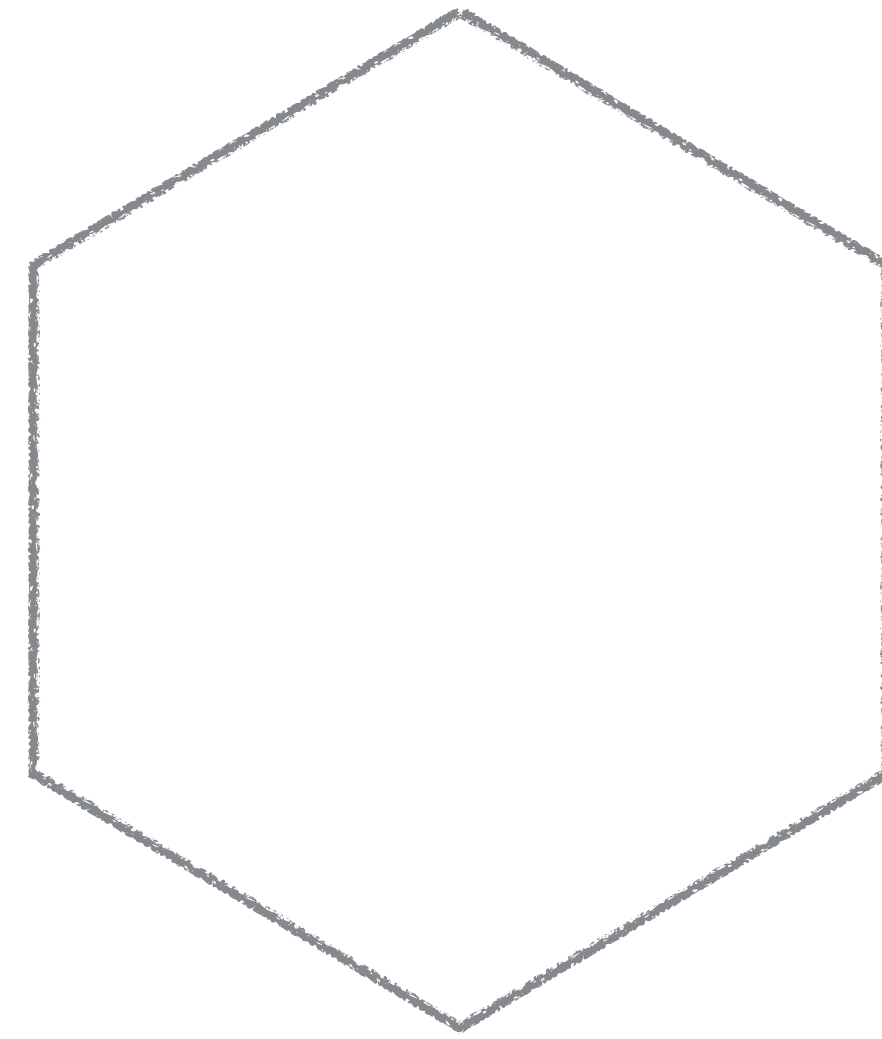
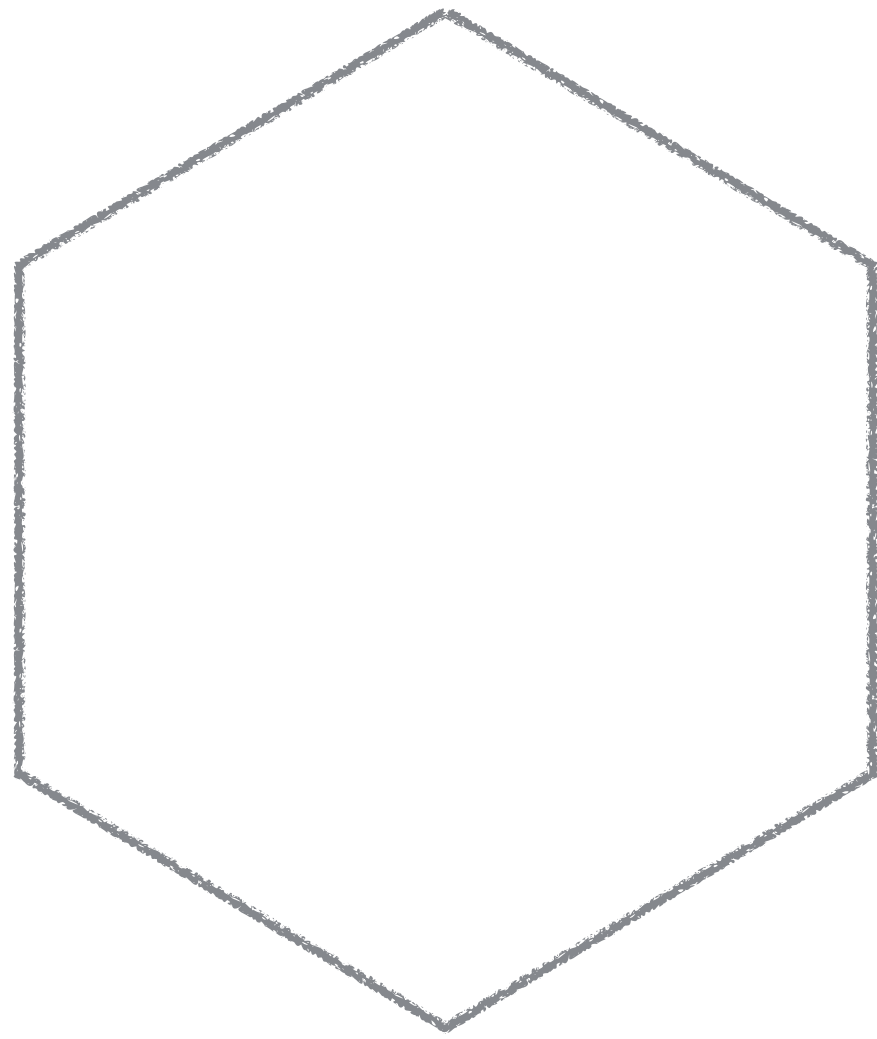

VERSION DRIFT

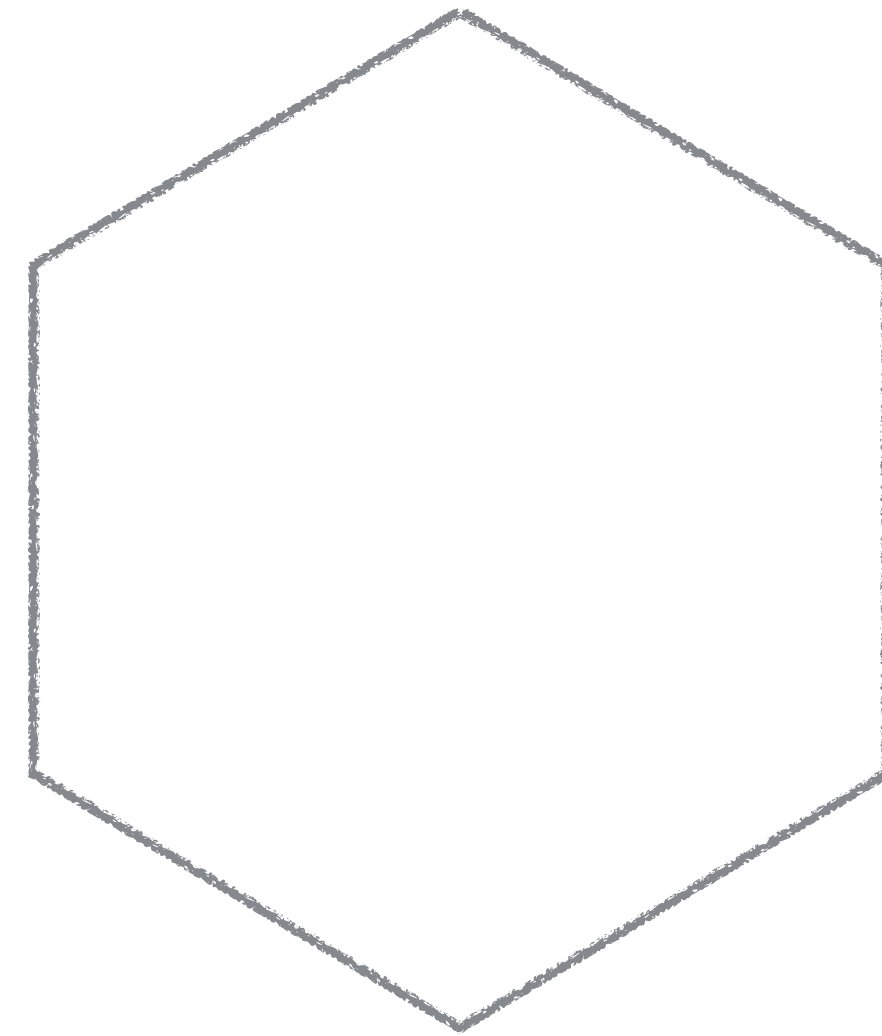
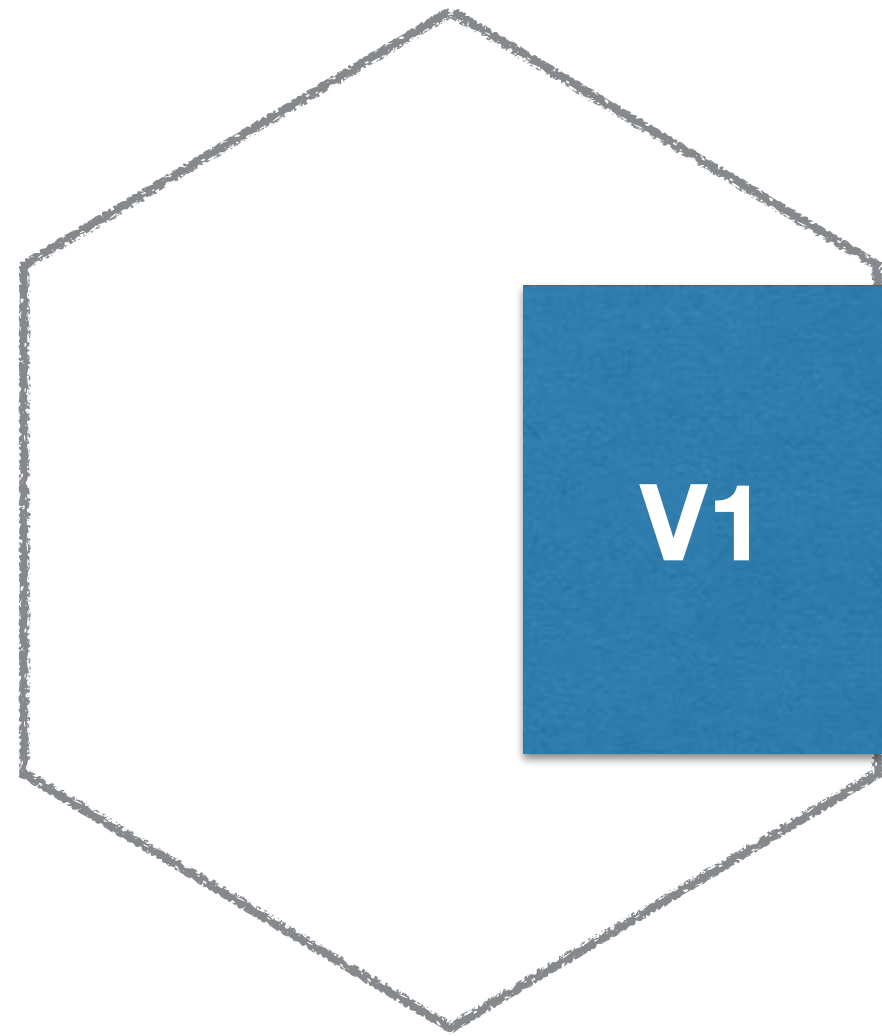

VERSION DRIFT

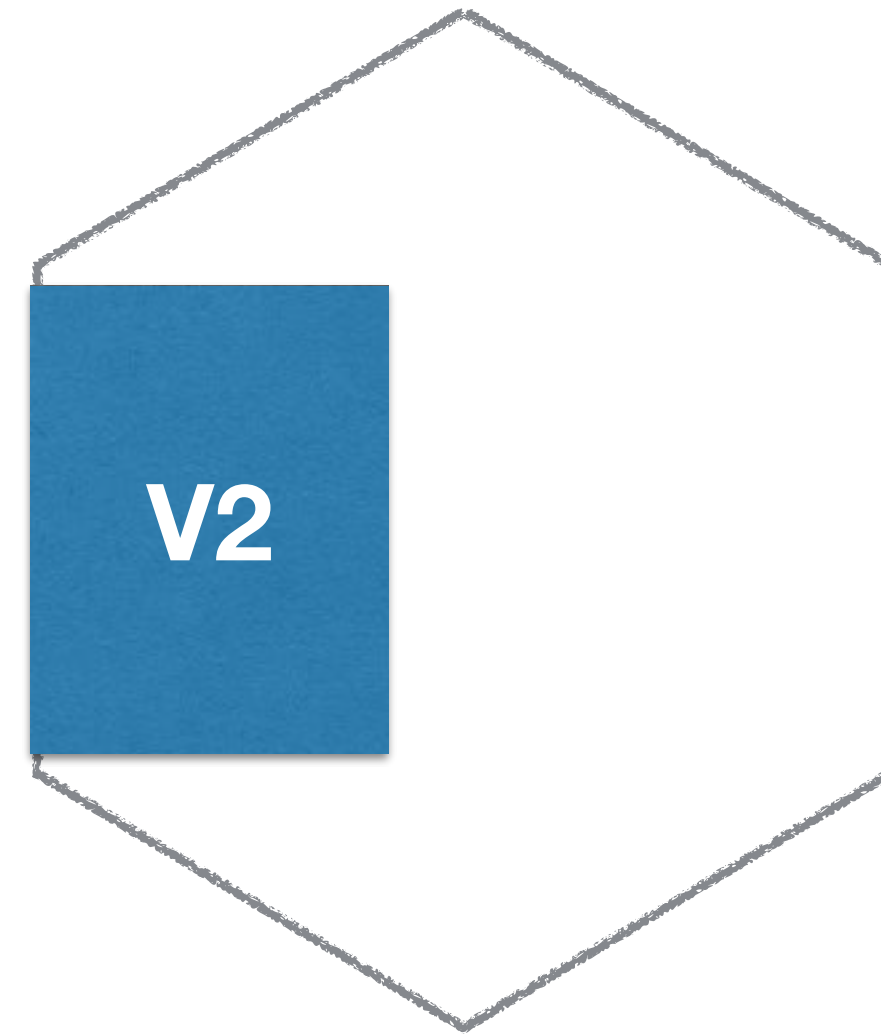
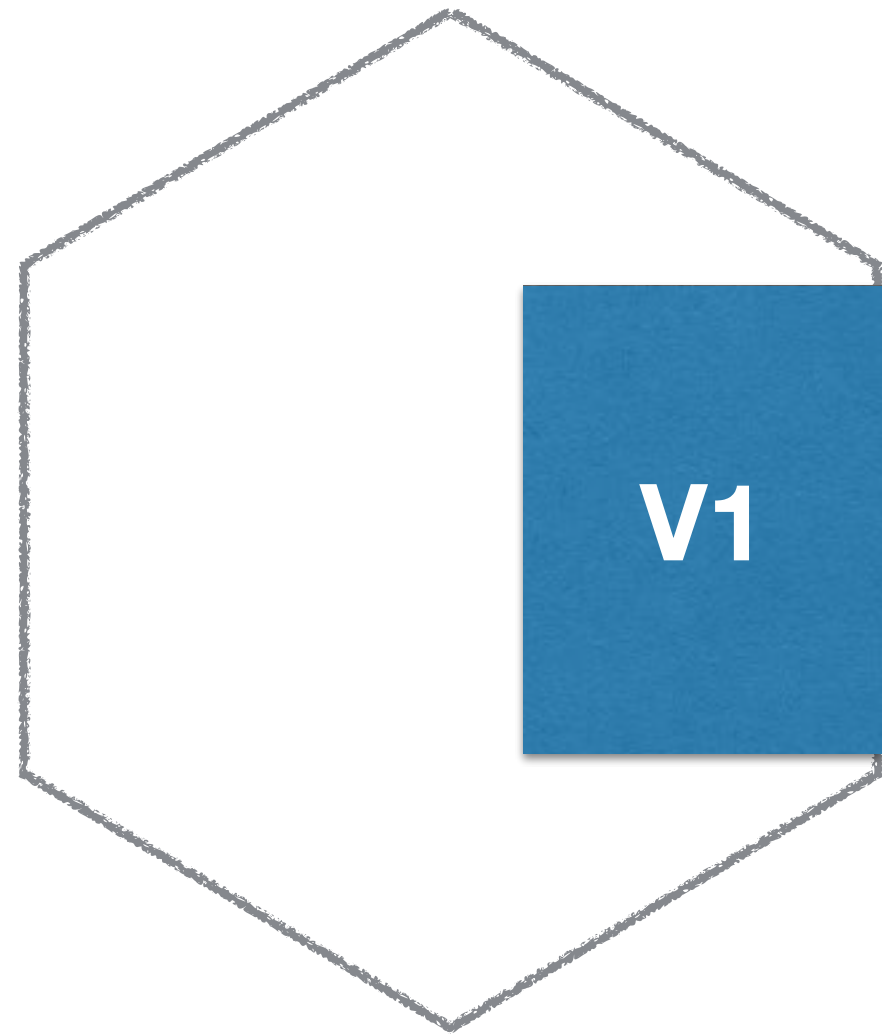

VERSION DRIFT

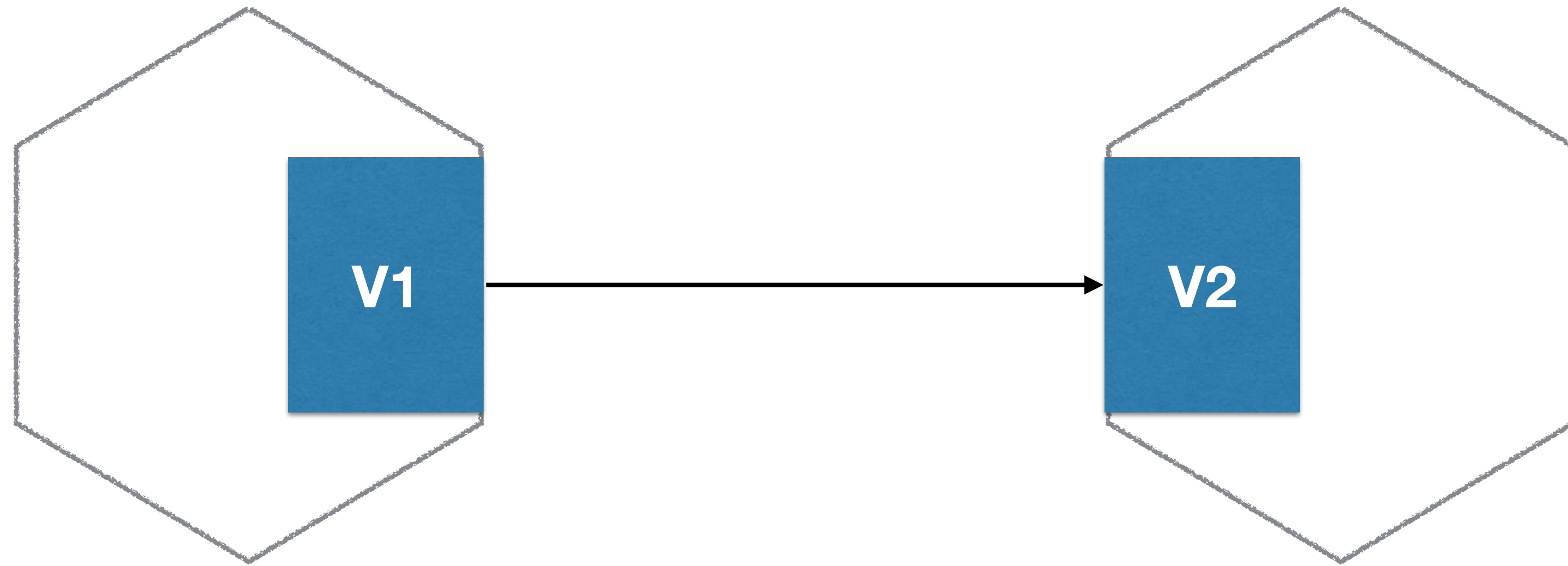

VERSION DRIFT

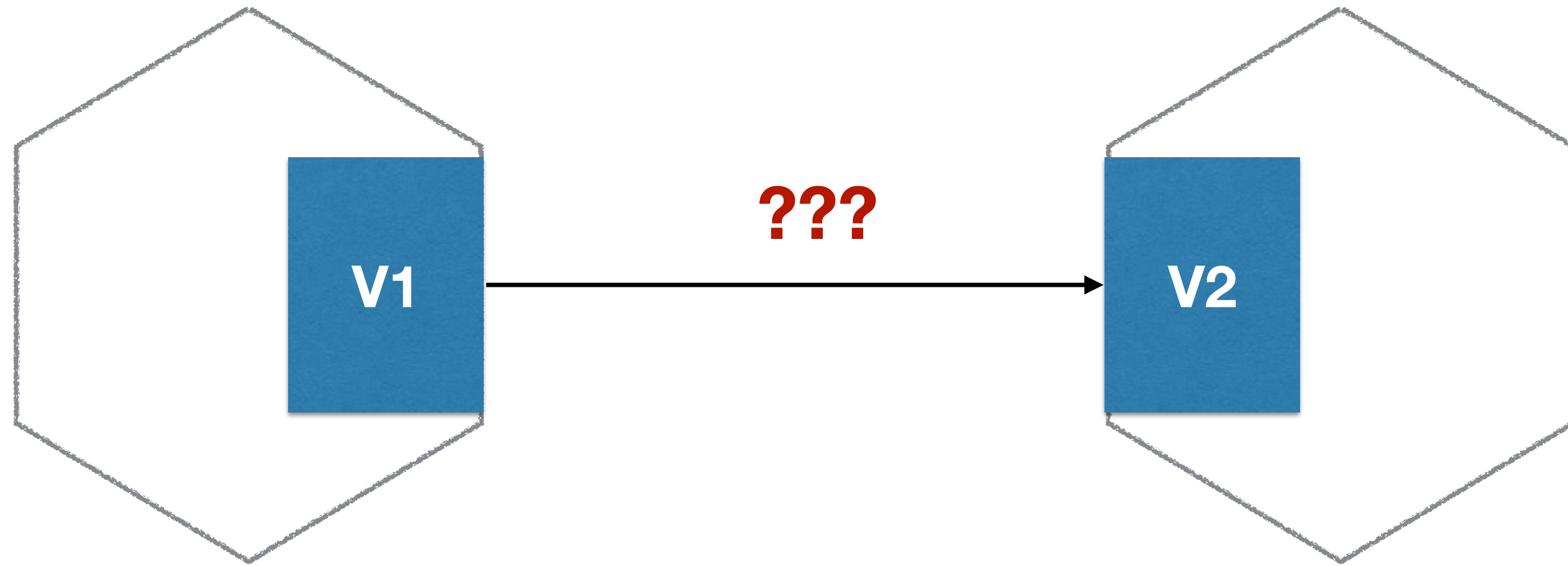

NETFLIX - ENFORCEMENT OF REUSE

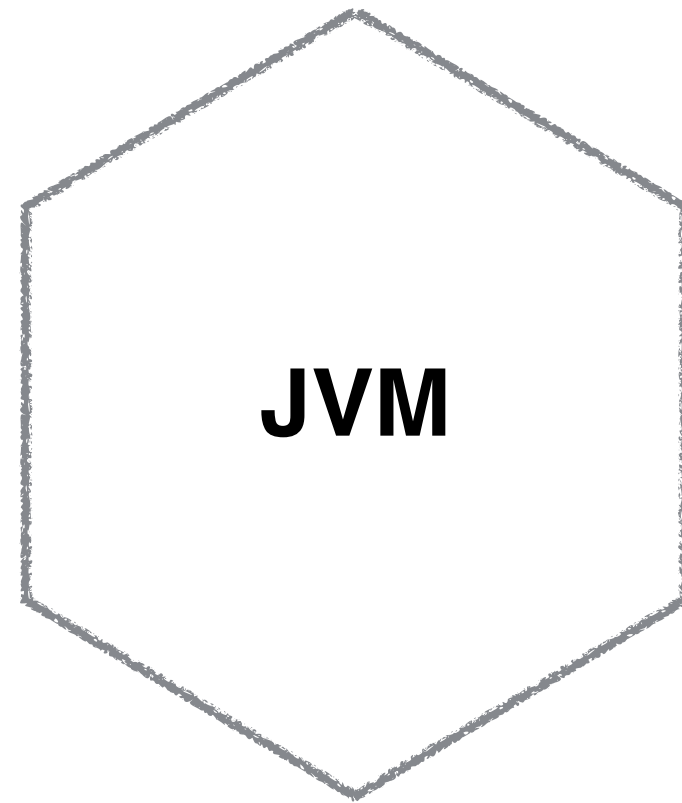
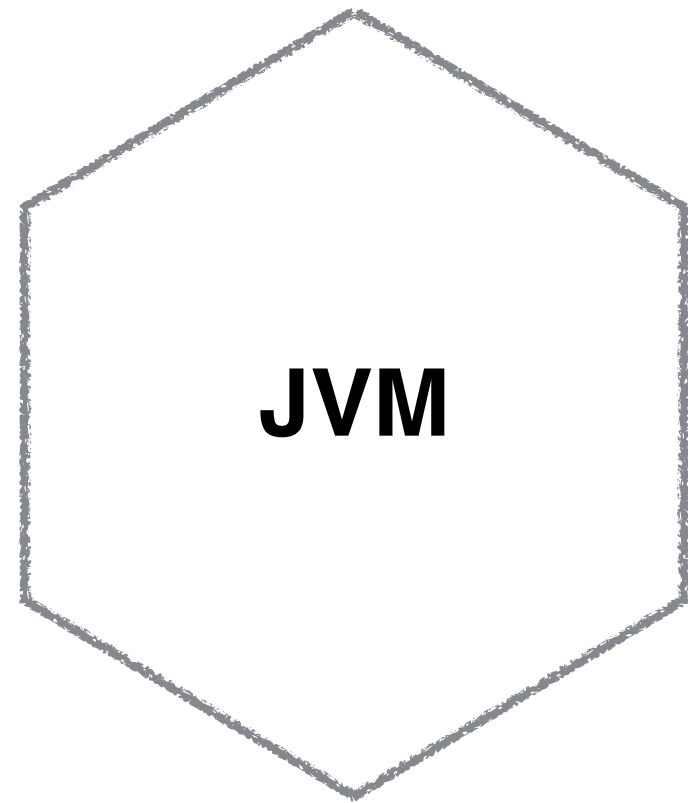

NETFLIX

NETFLIX - ENFORCEMENT OF REUSE

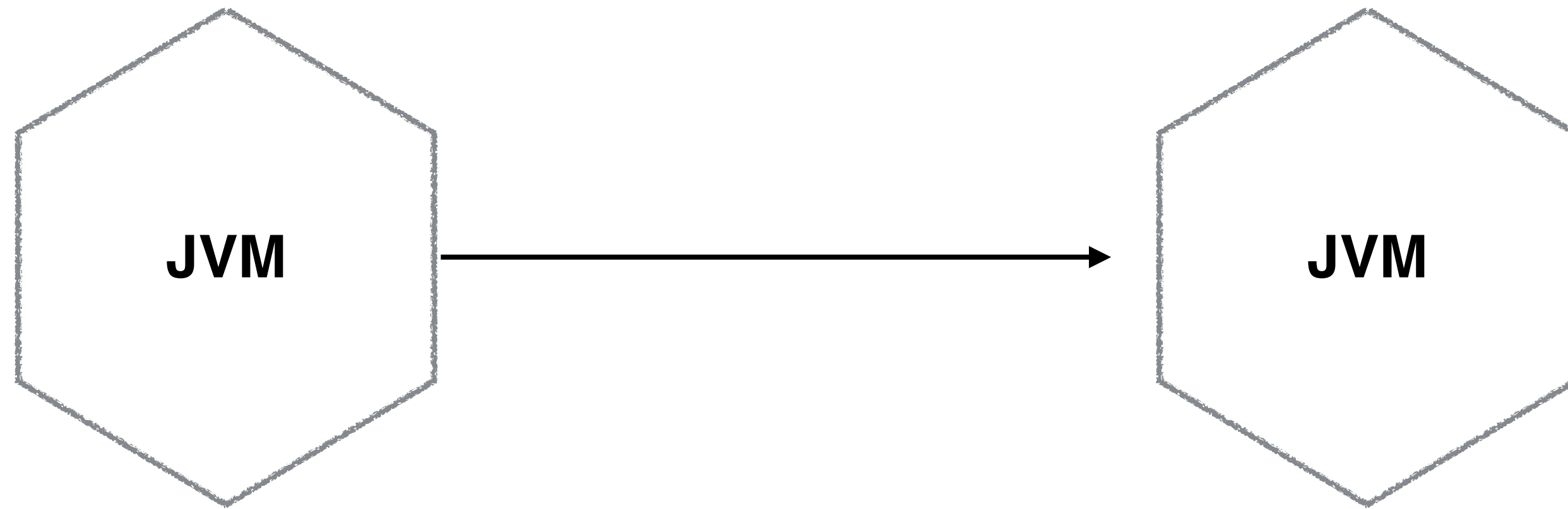

NETFLIX

NETFLIX - ENFORCEMENT OF REUSE

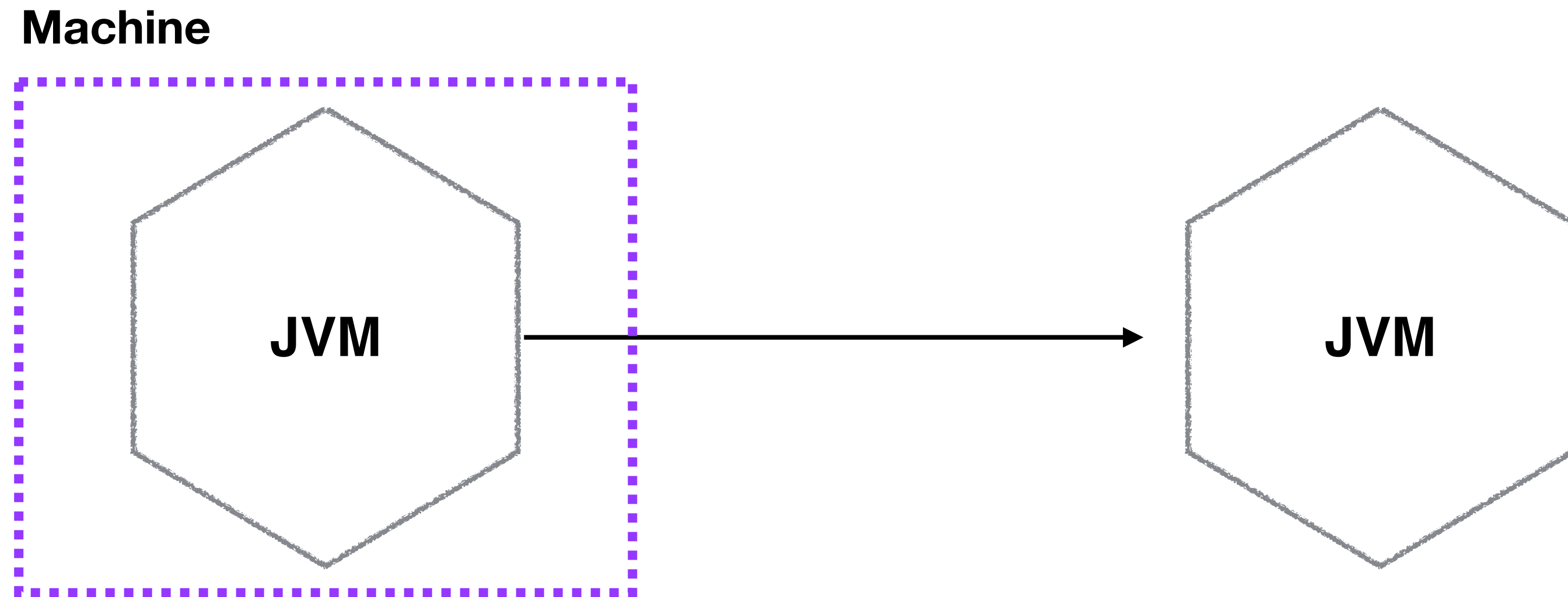

NETFLIX

NETFLIX - ENFORCEMENT OF REUSE

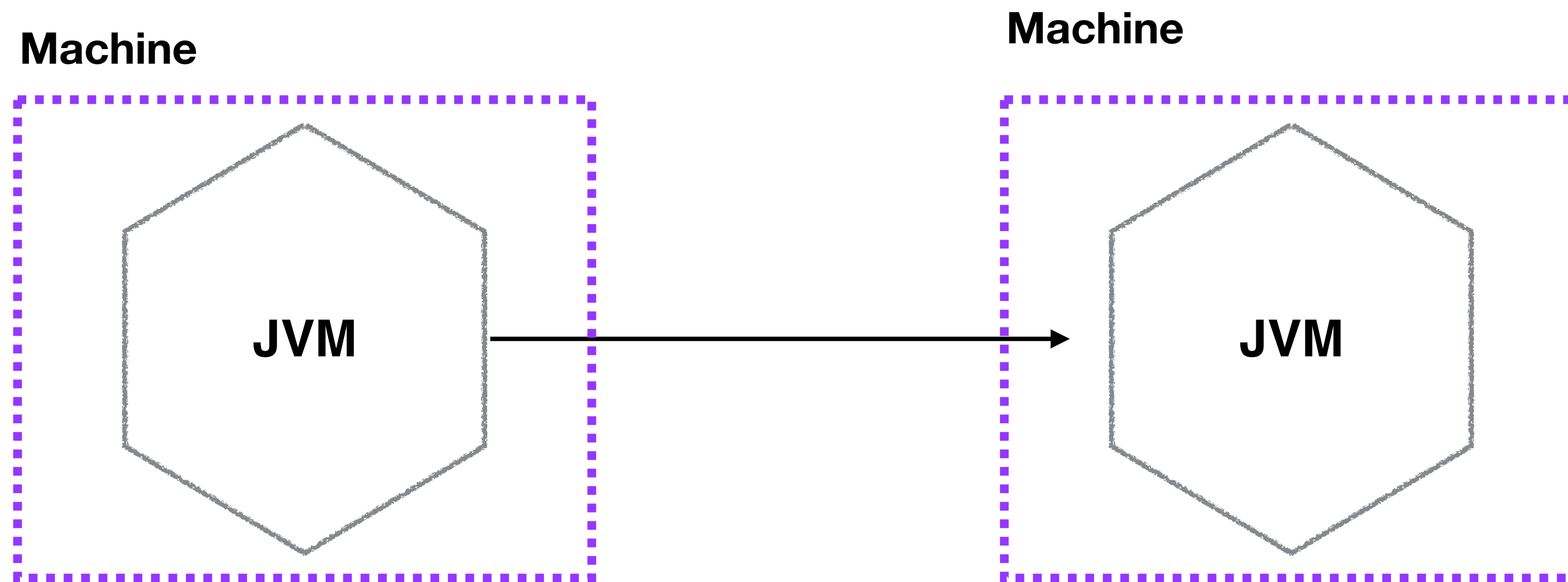

NETFLIX

NETFLIX - ENFORCEMENT OF REUSE

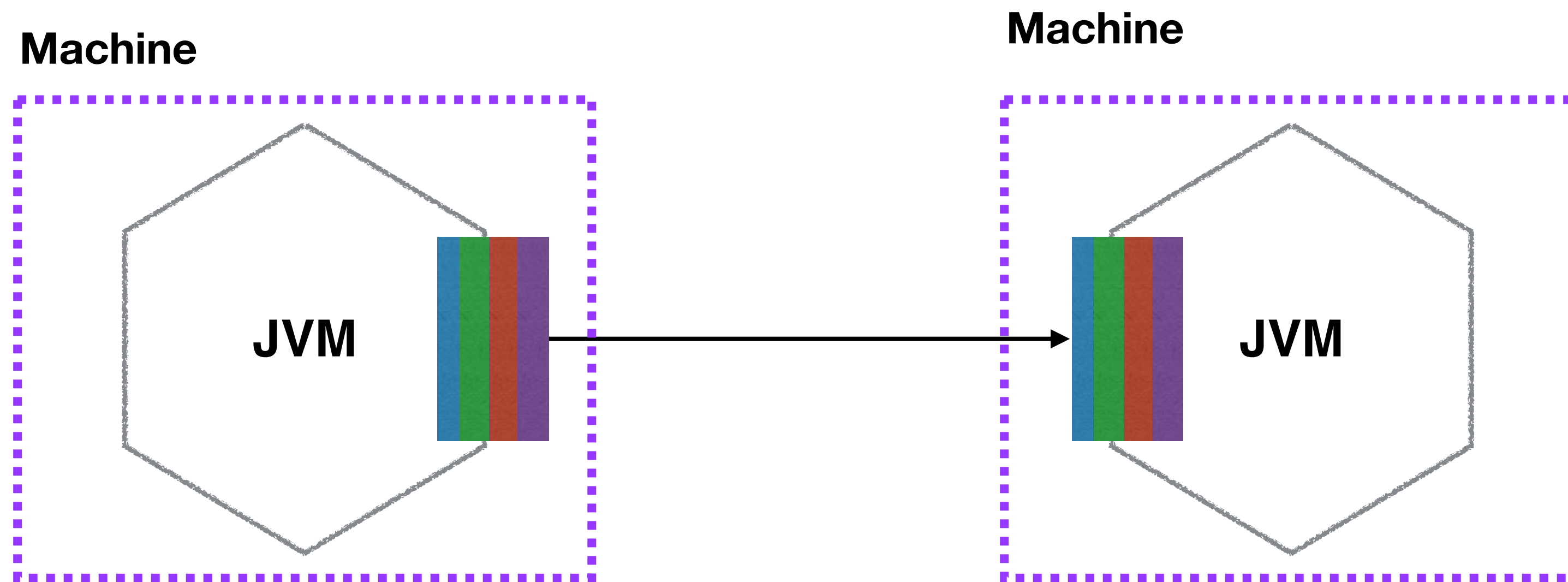

NETFLIX

NETFLIX - ENFORCEMENT OF REUSE

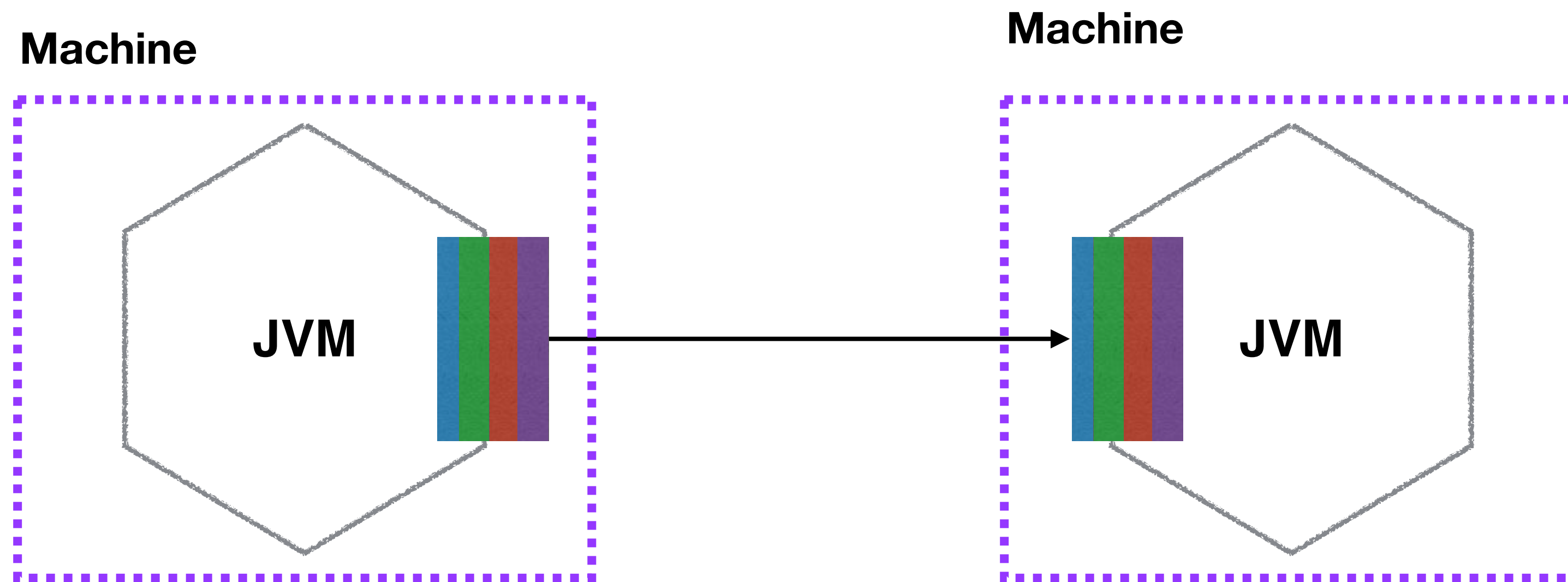

NETFLIX

What about non-JVM languages?

NETFLIX - SIDECAR PATTERN

Machine

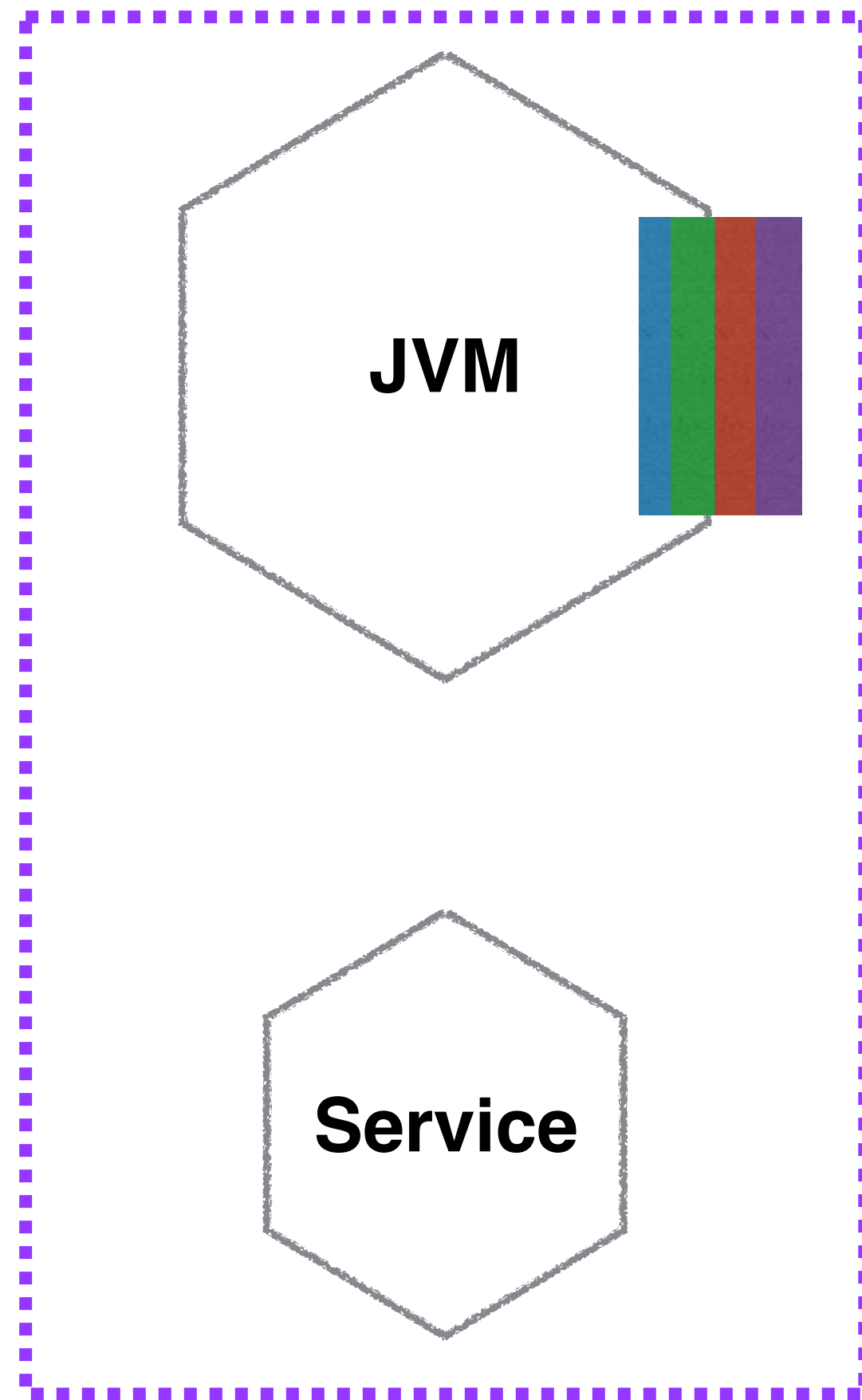

Machine

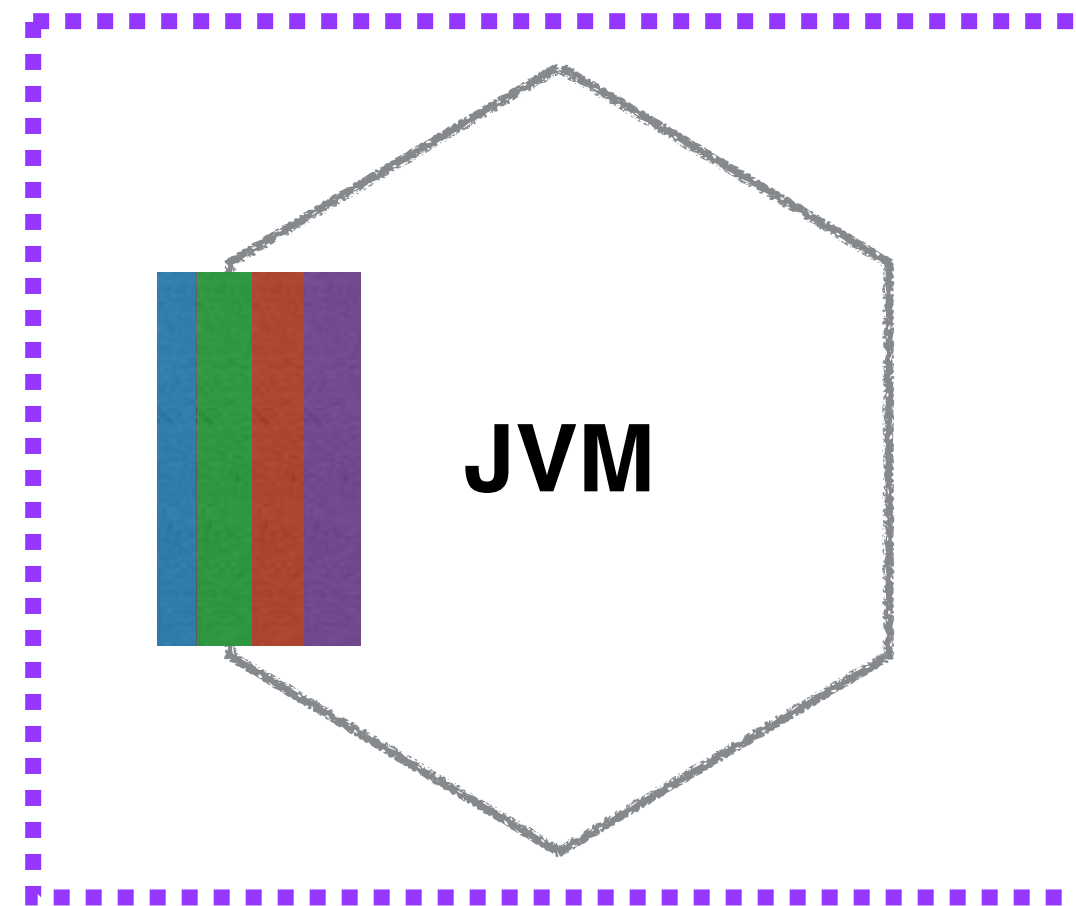

NETFLIX - SIDECAR PATTERN

Machine

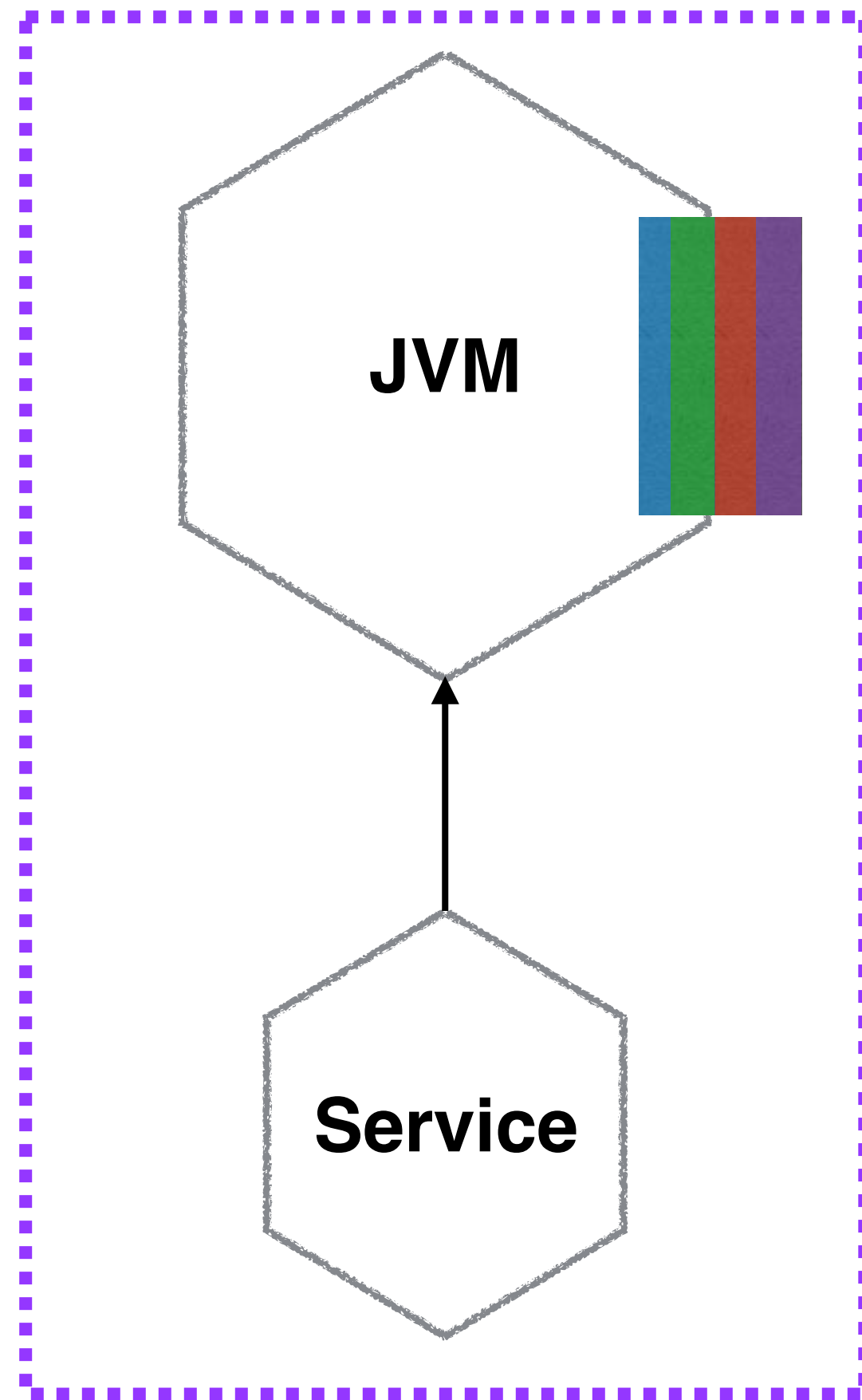

Machine

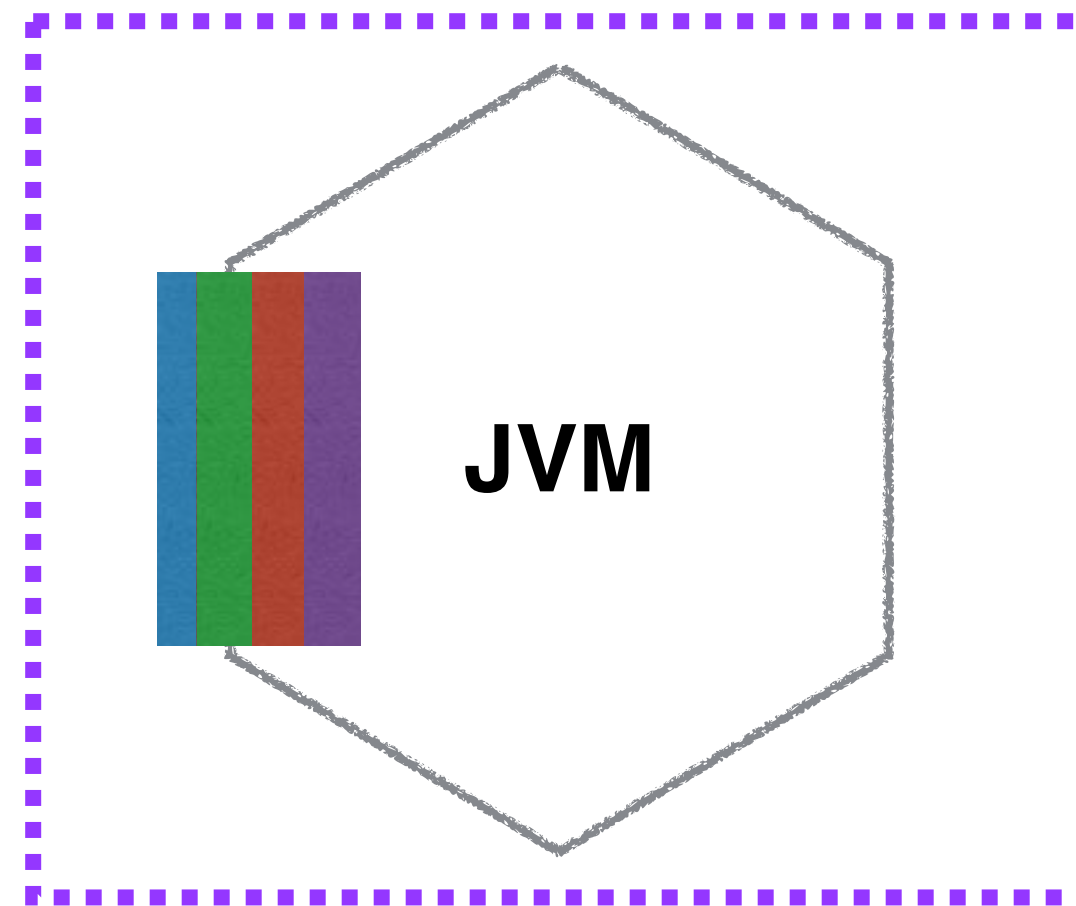

NETFLIX - SIDECAR PATTERN

Machine

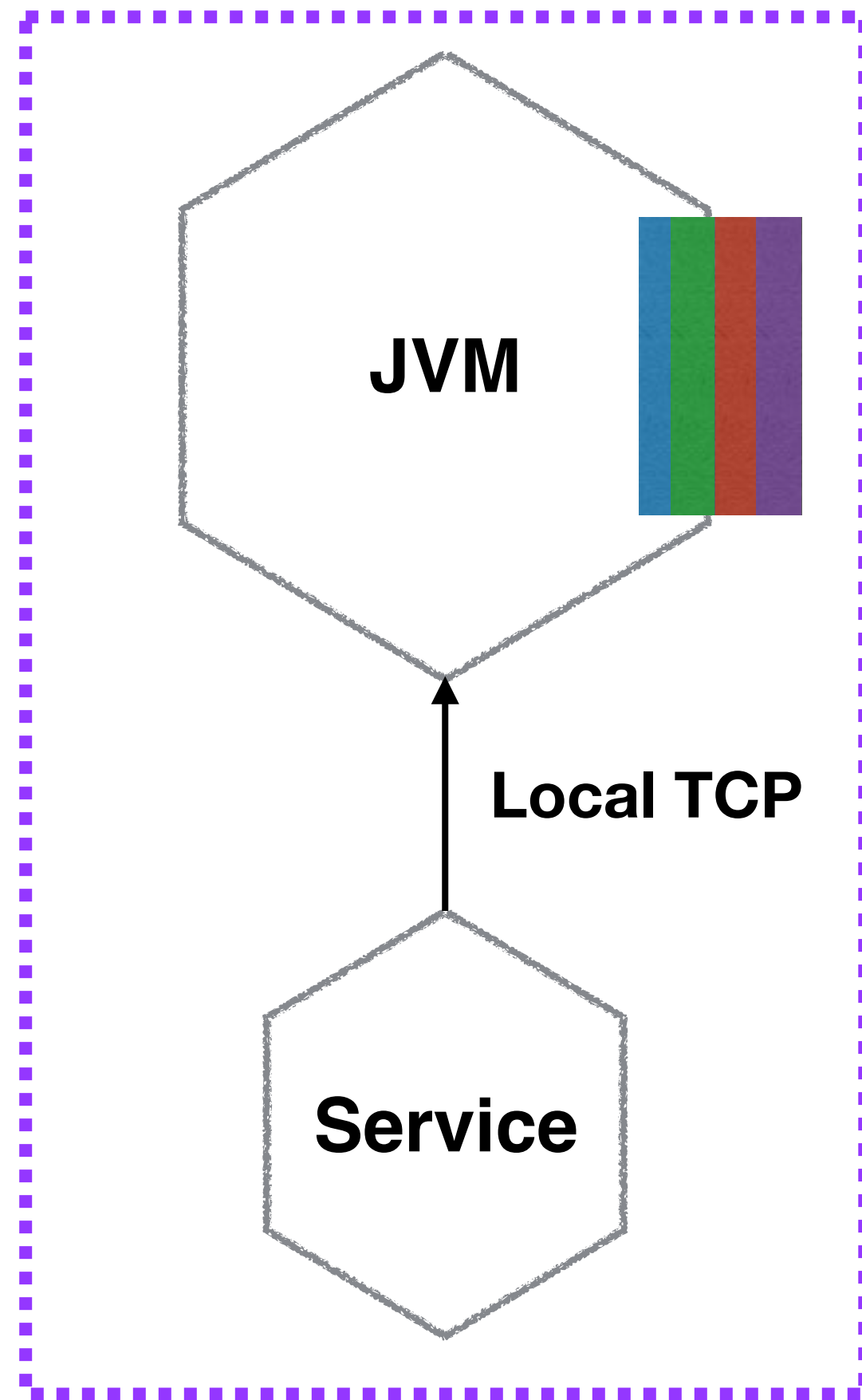

Machine

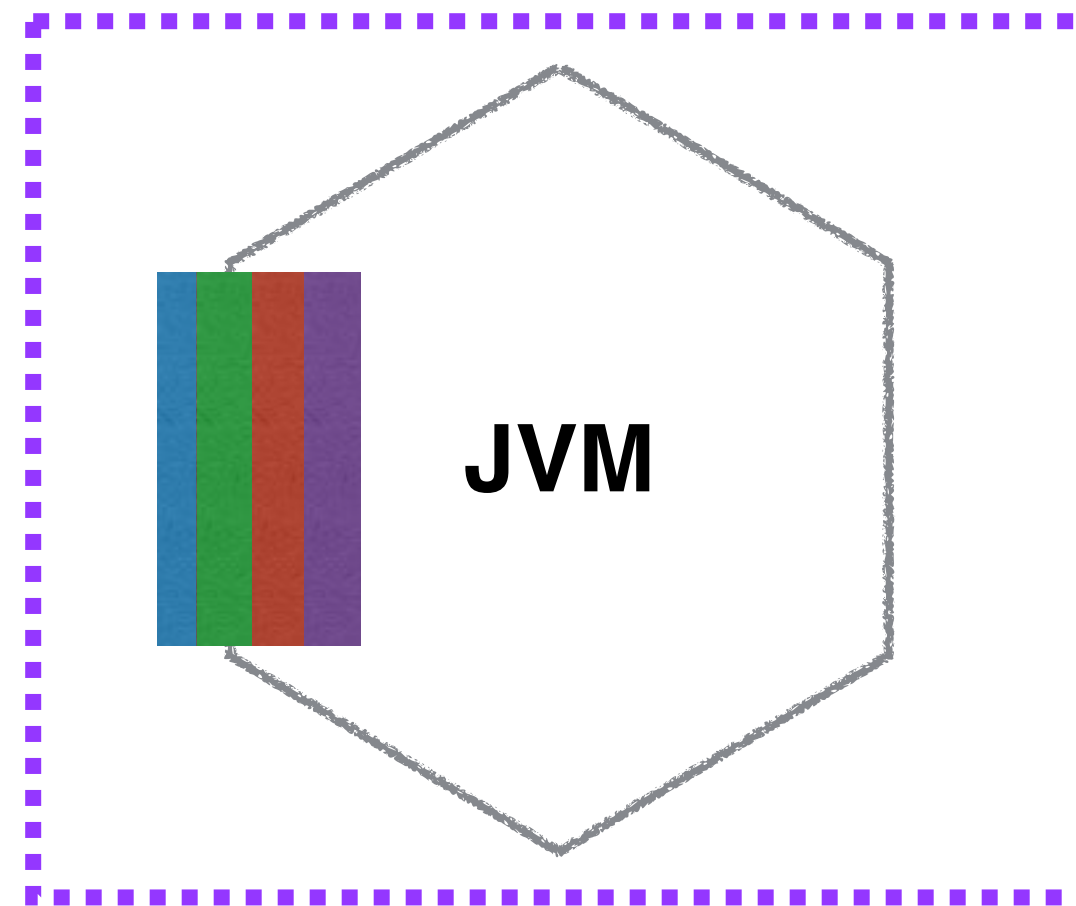

NETFLIX - SIDECAR PATTERN

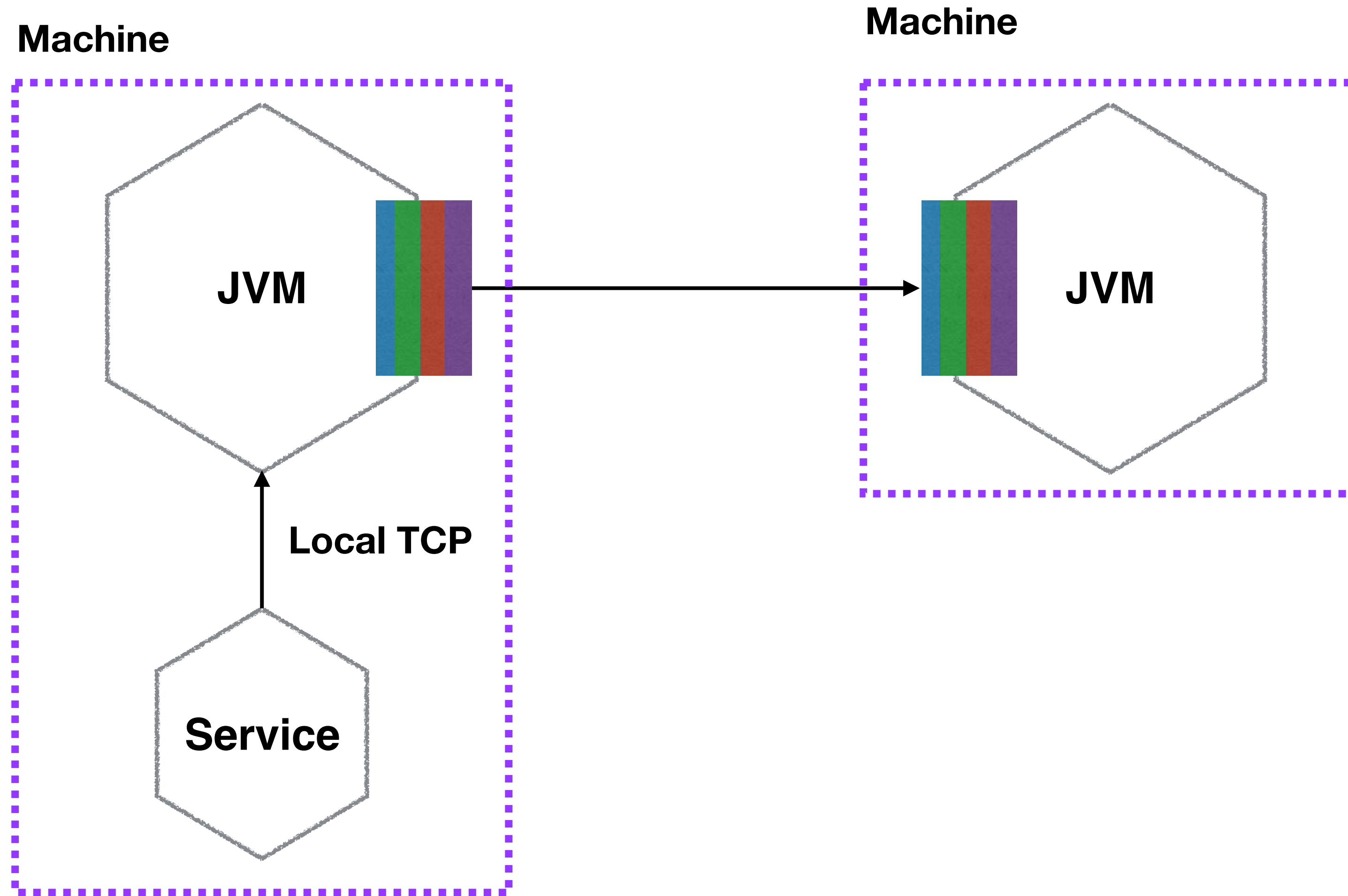

NETFLIX - SIDECAR PATTERN

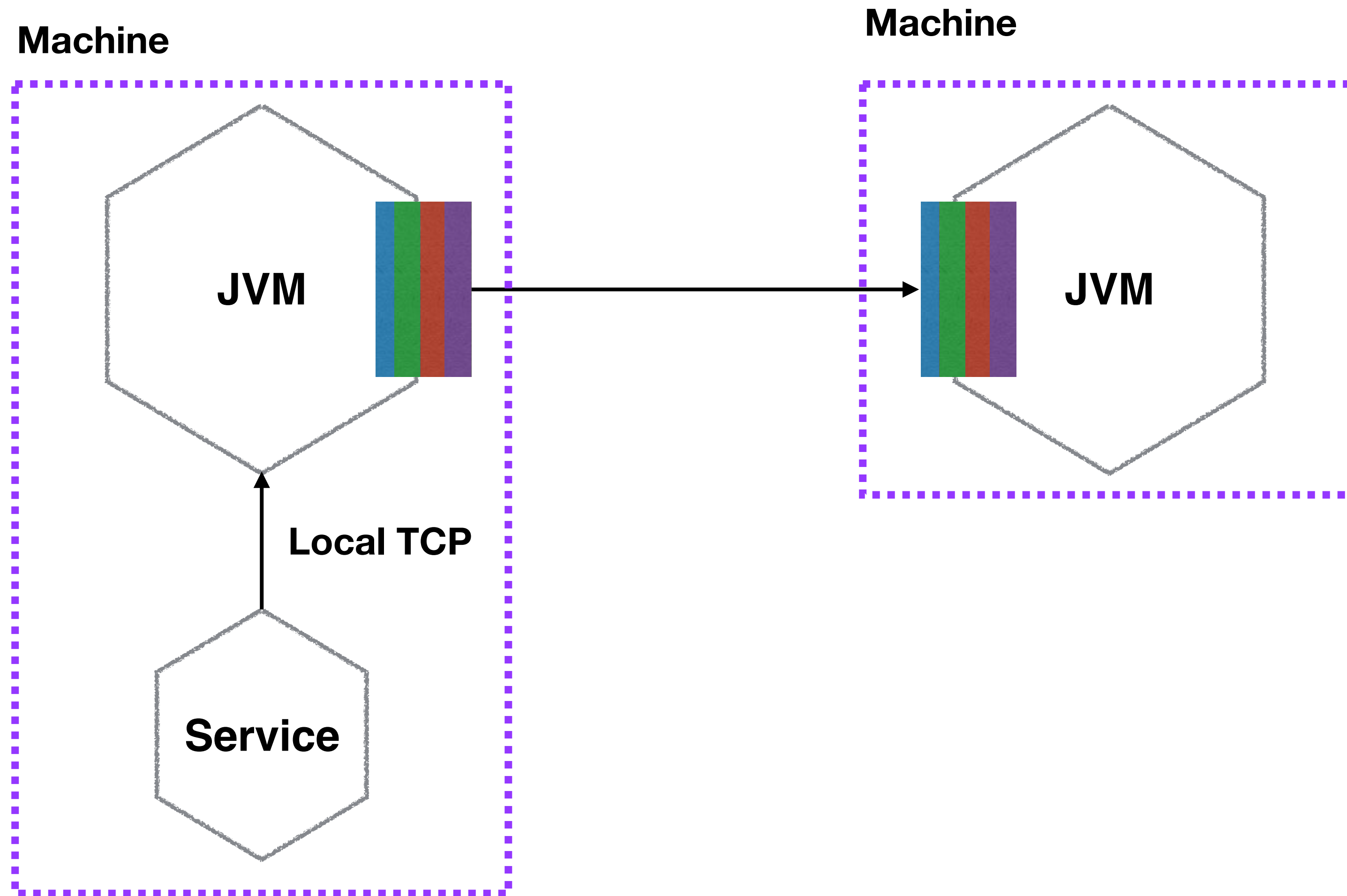

Re-use code across tech stacks

NETFLIX - SIDECAR PATTERN

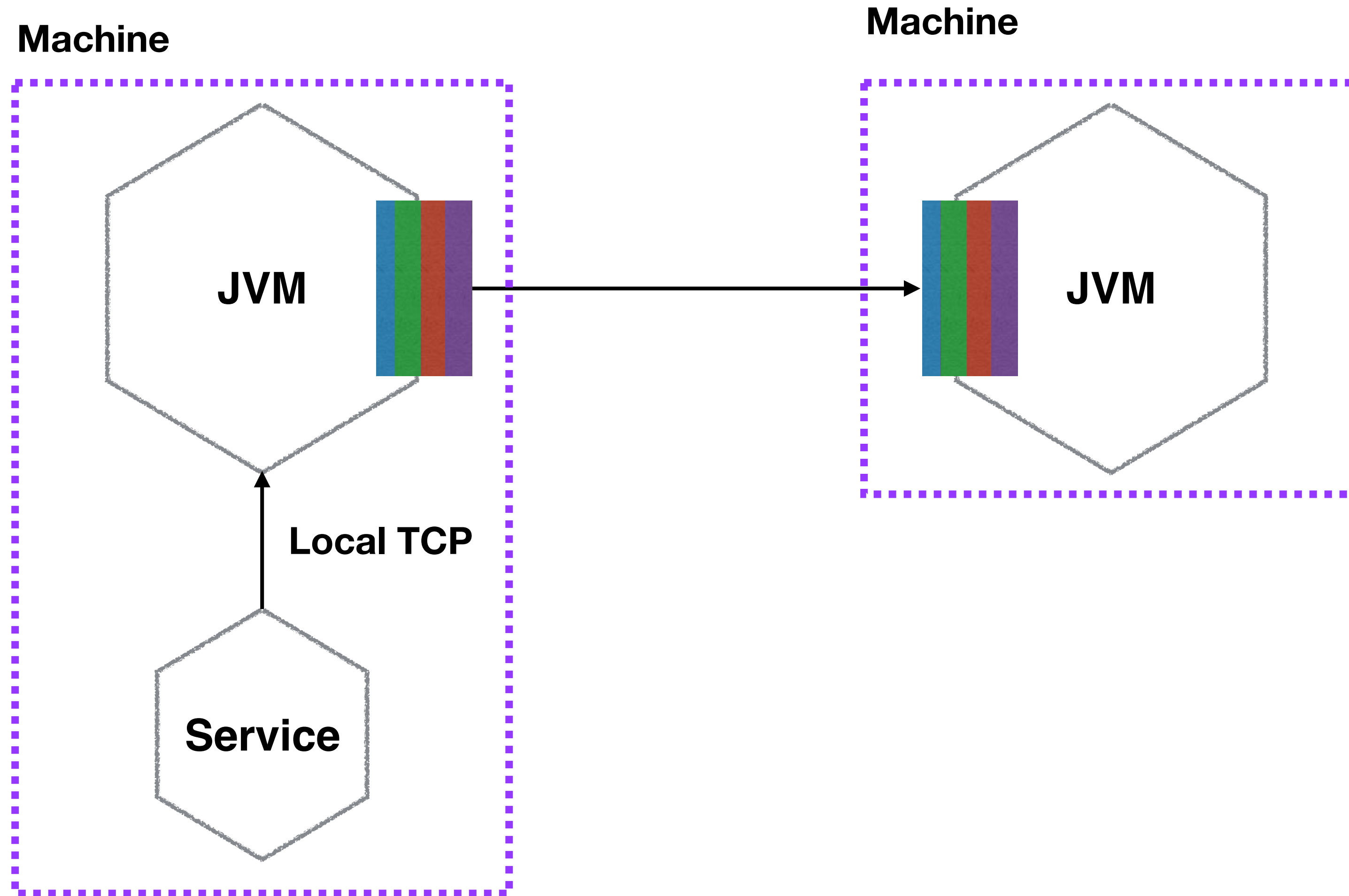

Re-use code across tech stacks

Reduce impact of version drift

FROM PROXIES TO SERVICE MESHES

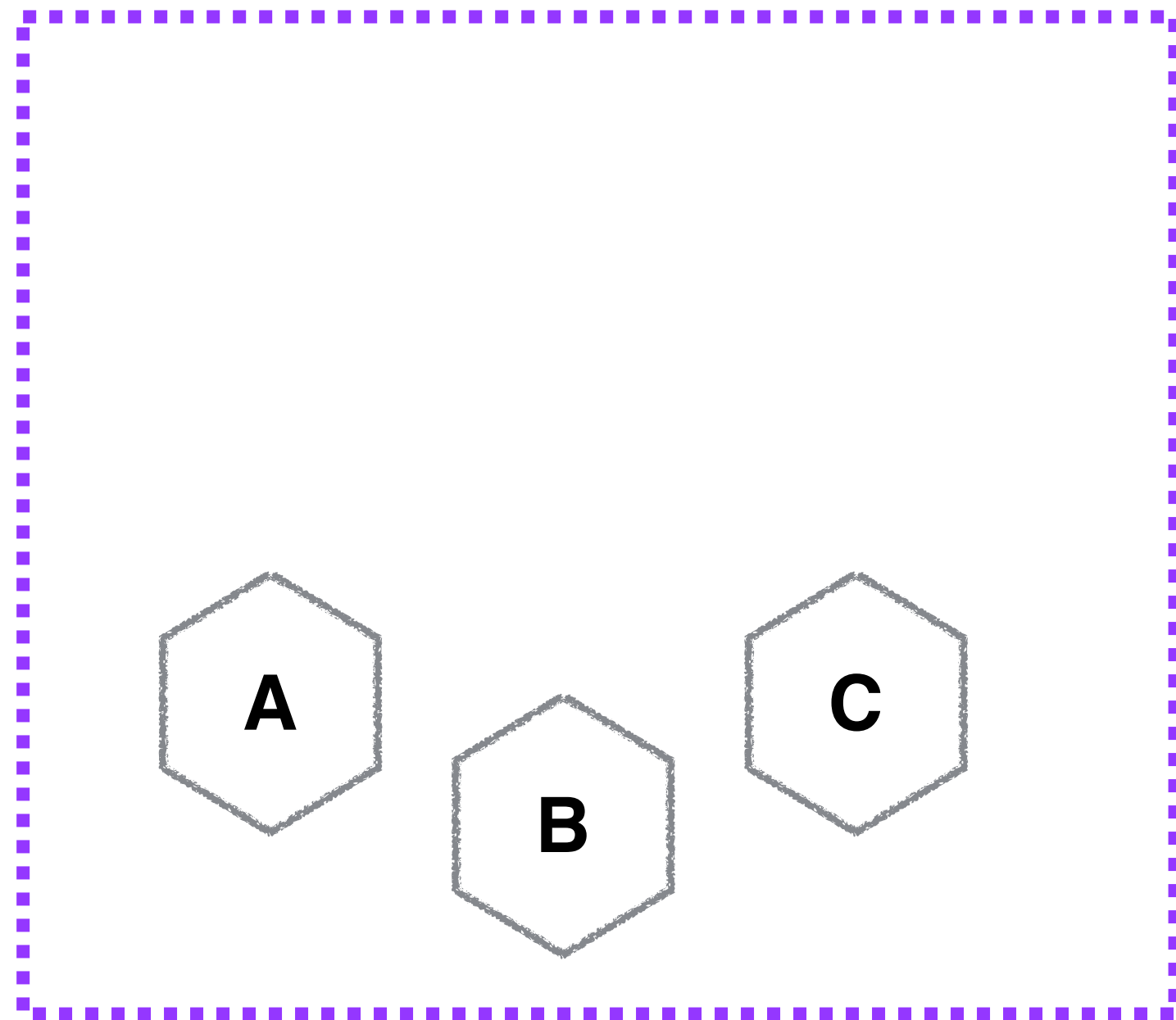

Machine

FROM PROXIES TO SERVICE MESHES

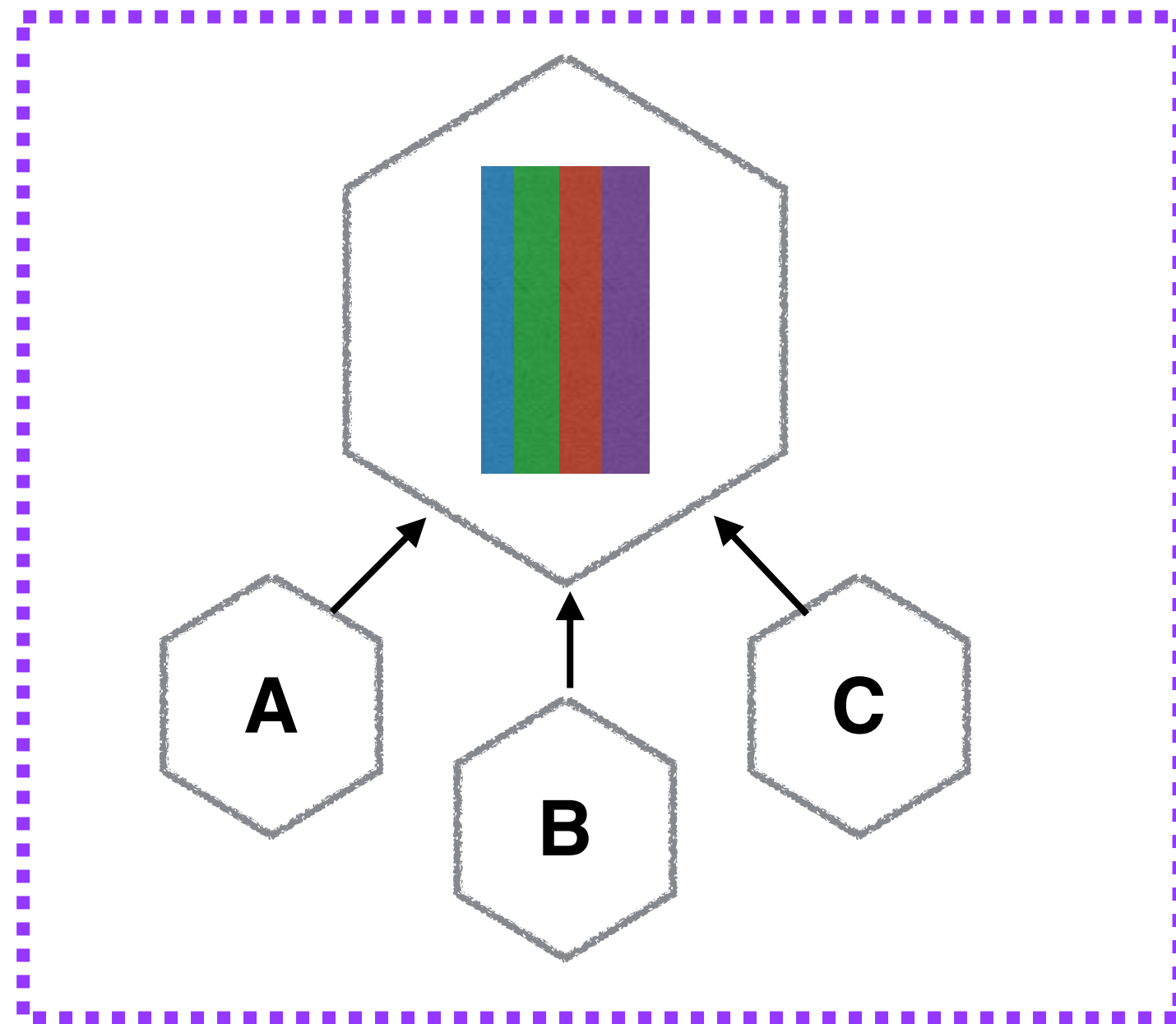

Machine

FROM PROXIES TO SERVICE MESHES

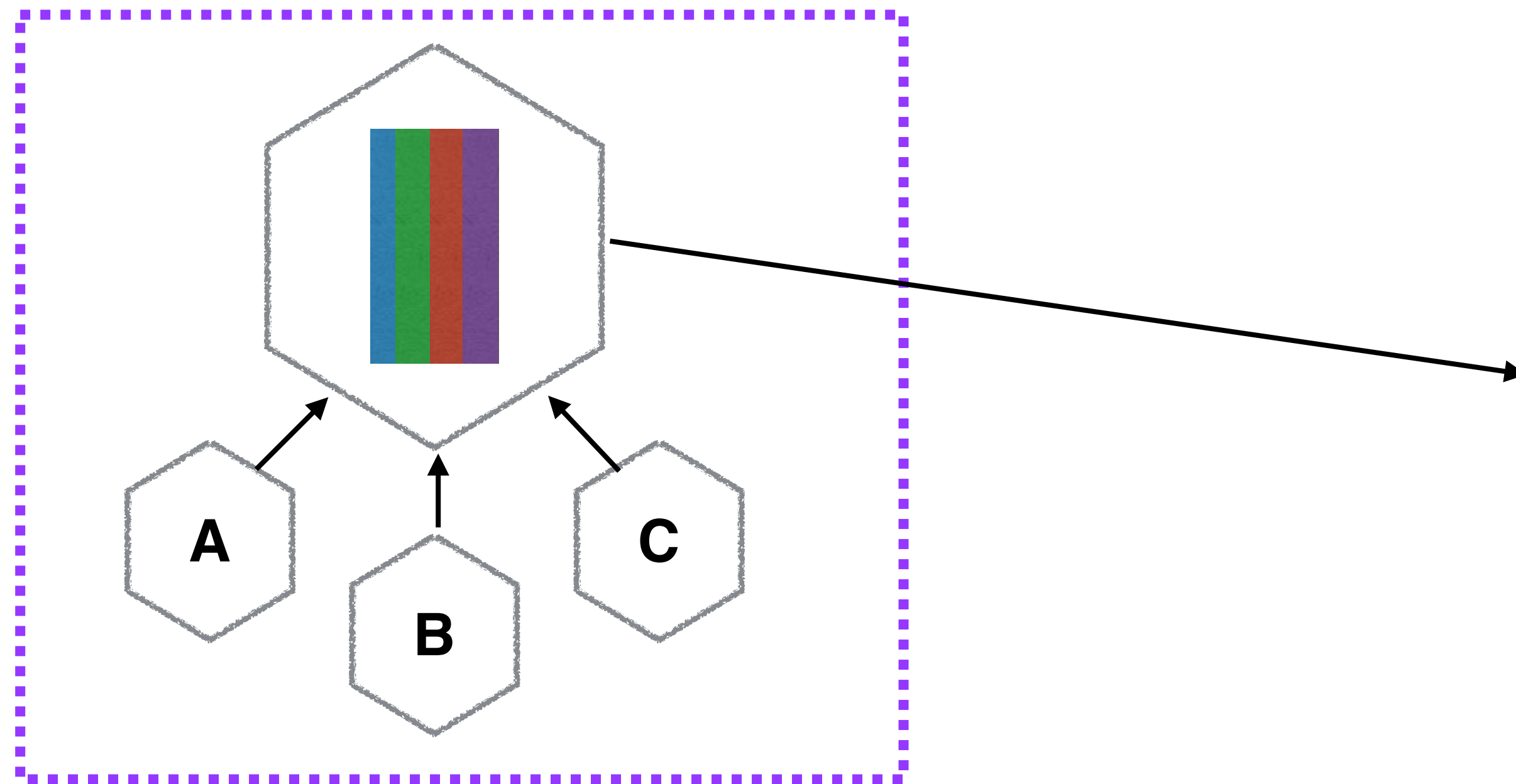

Machine

FROM PROXIES TO SERVICE MESHES

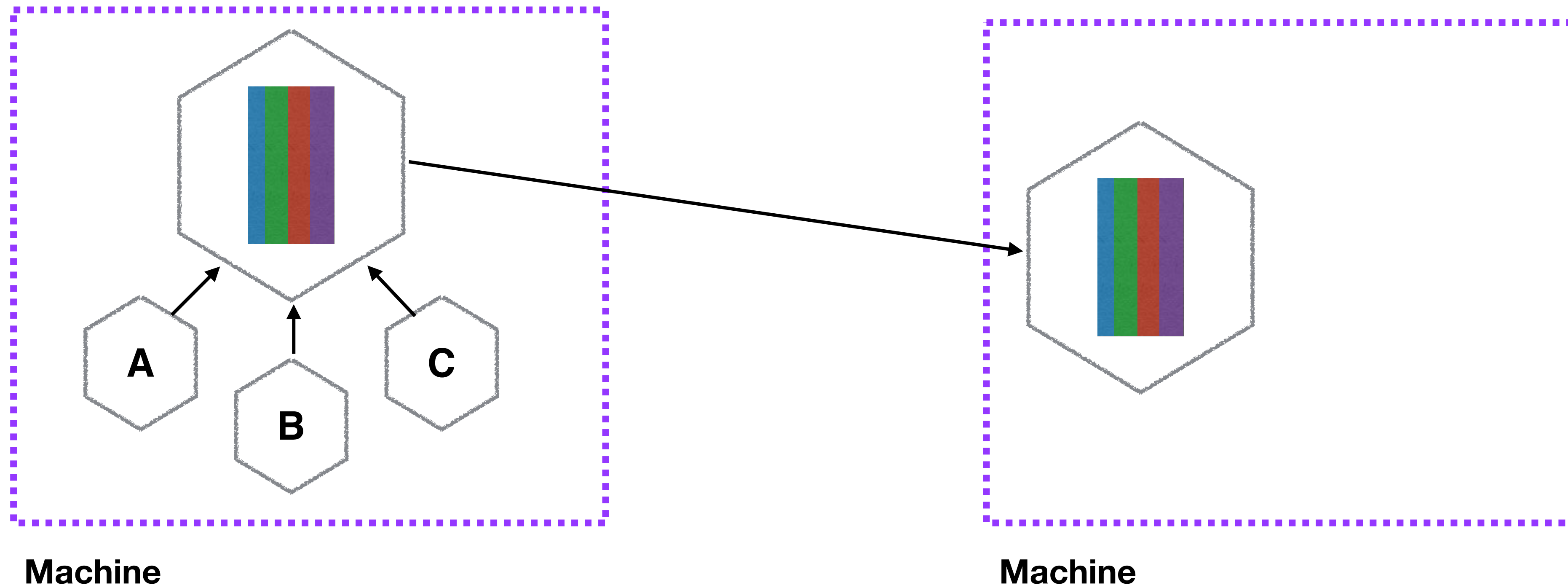

FROM PROXIES TO SERVICE MESHES

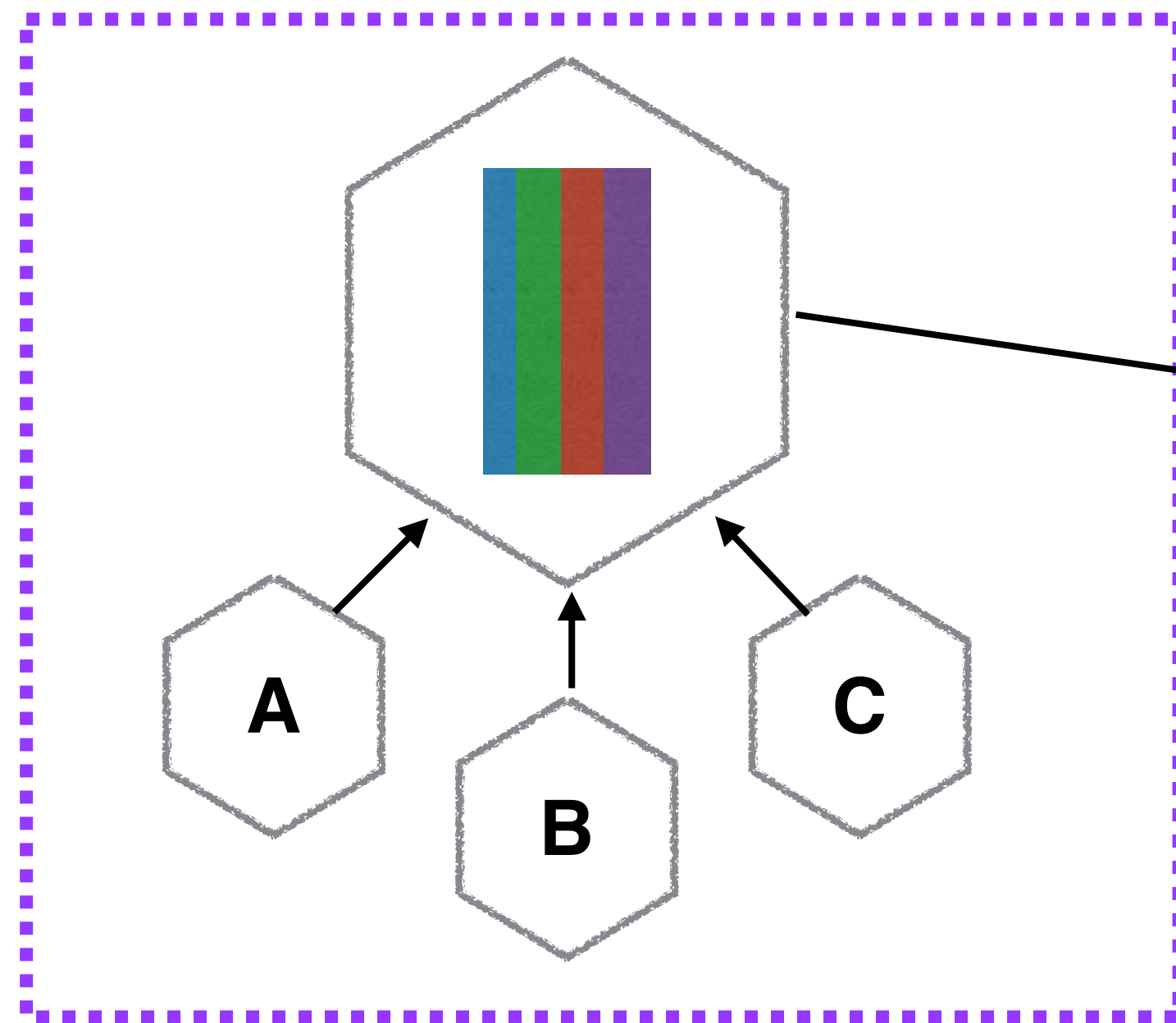

Machine

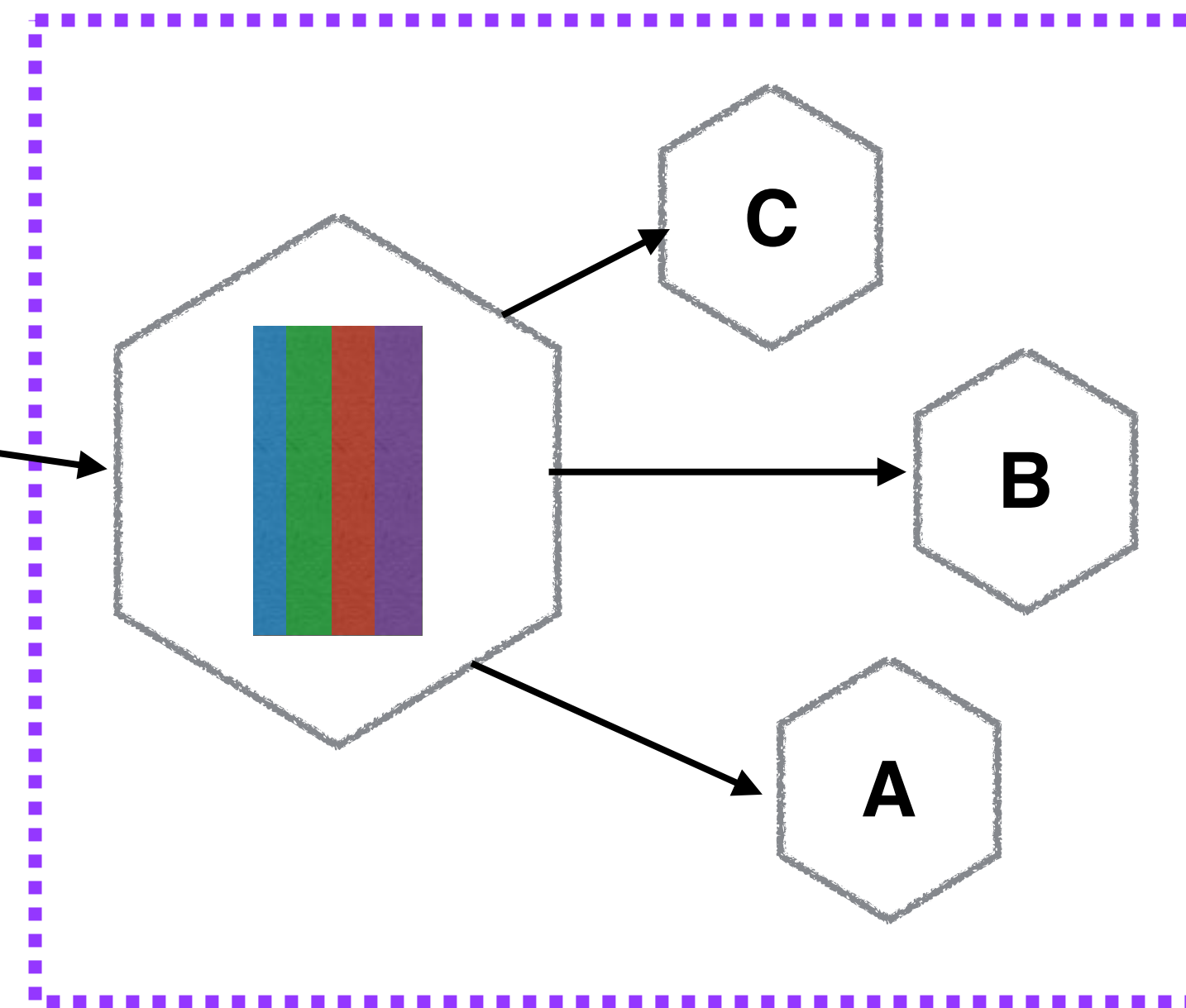

Machine

FROM PROXIES TO SERVICE MESHES

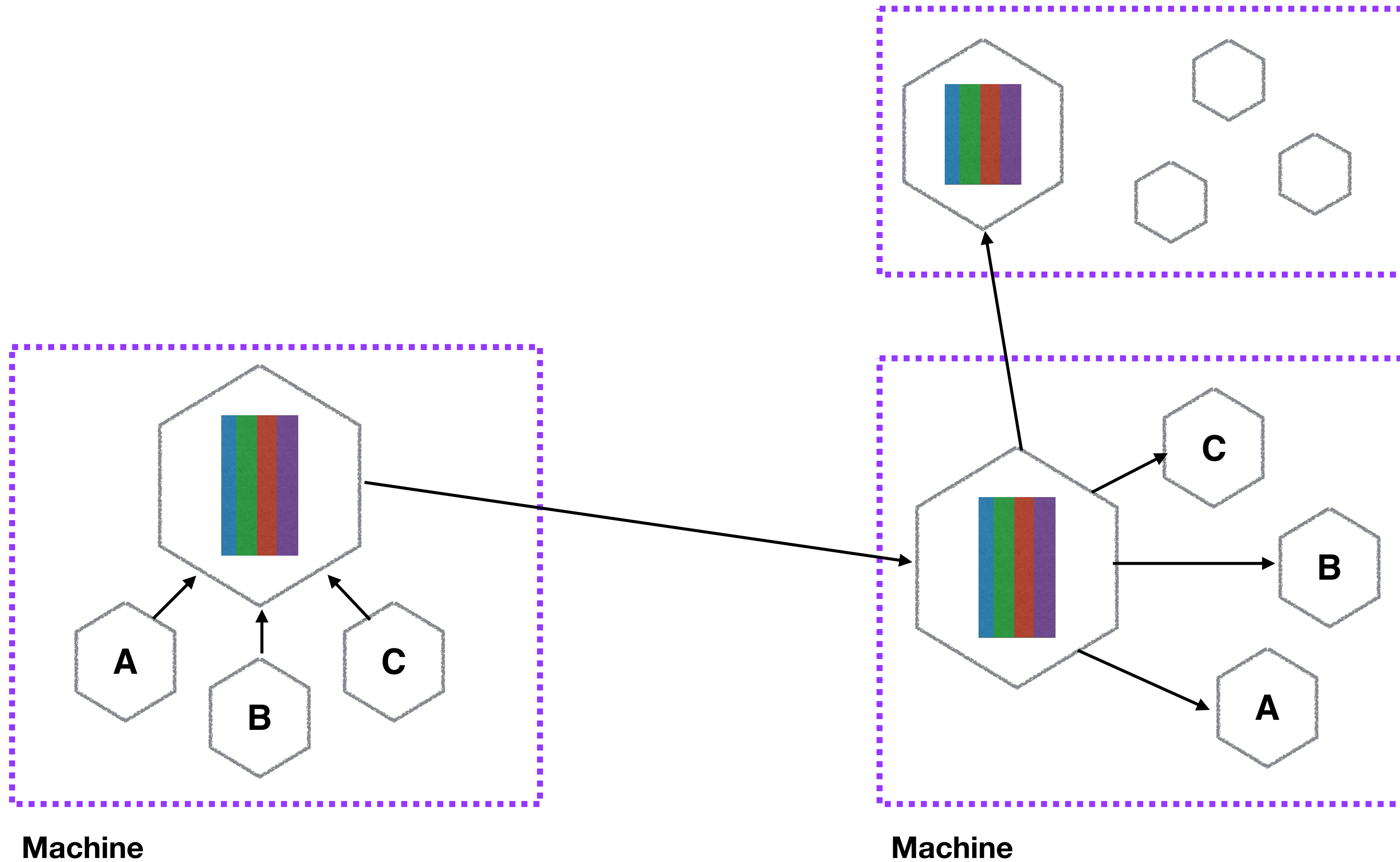

FROM PROXIES TO SERVICE MESHES

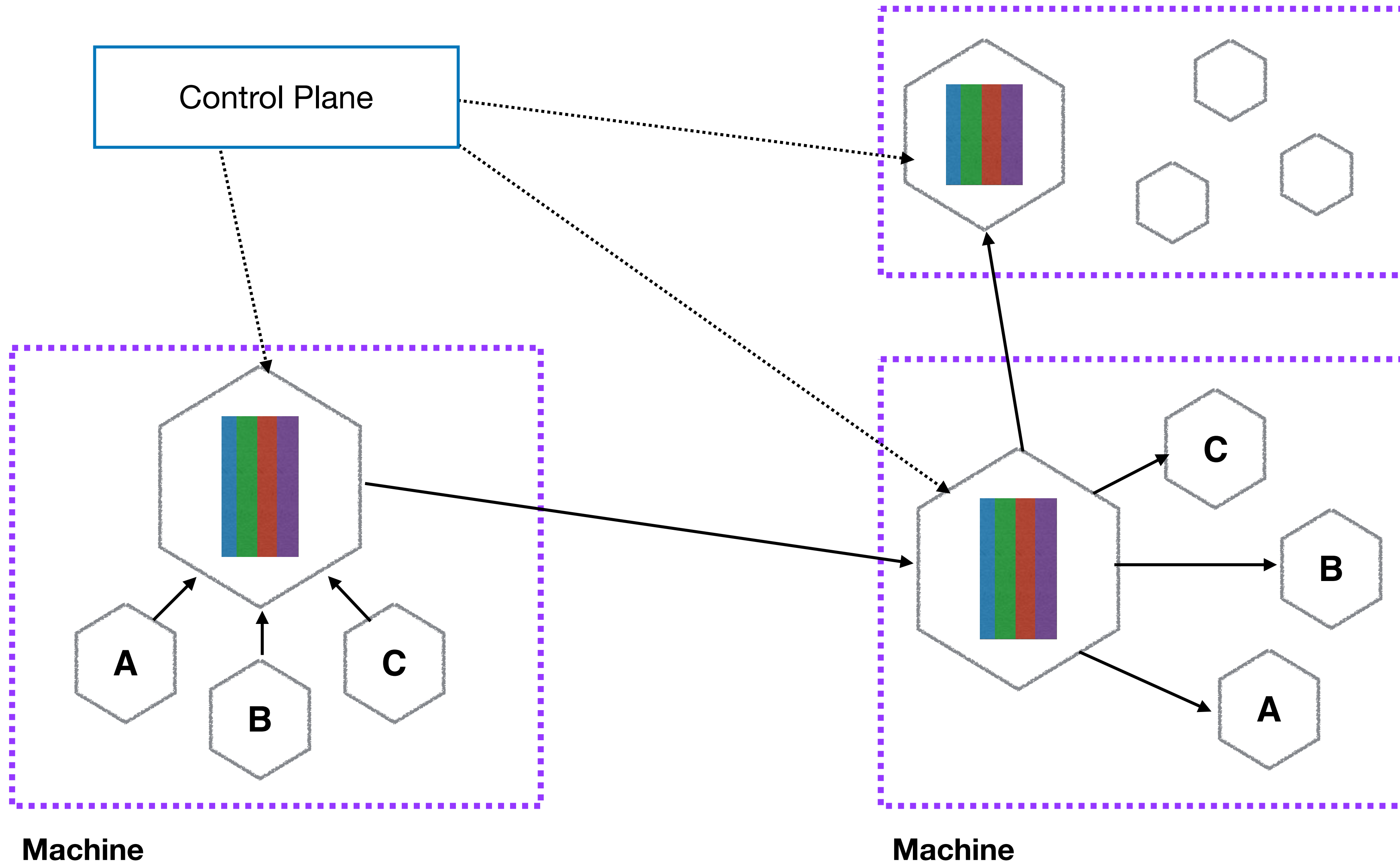

SIDECARS VS PROXIES

Local Proxy

Sidecar



SIDECARS VS PROXIES

Local Proxy

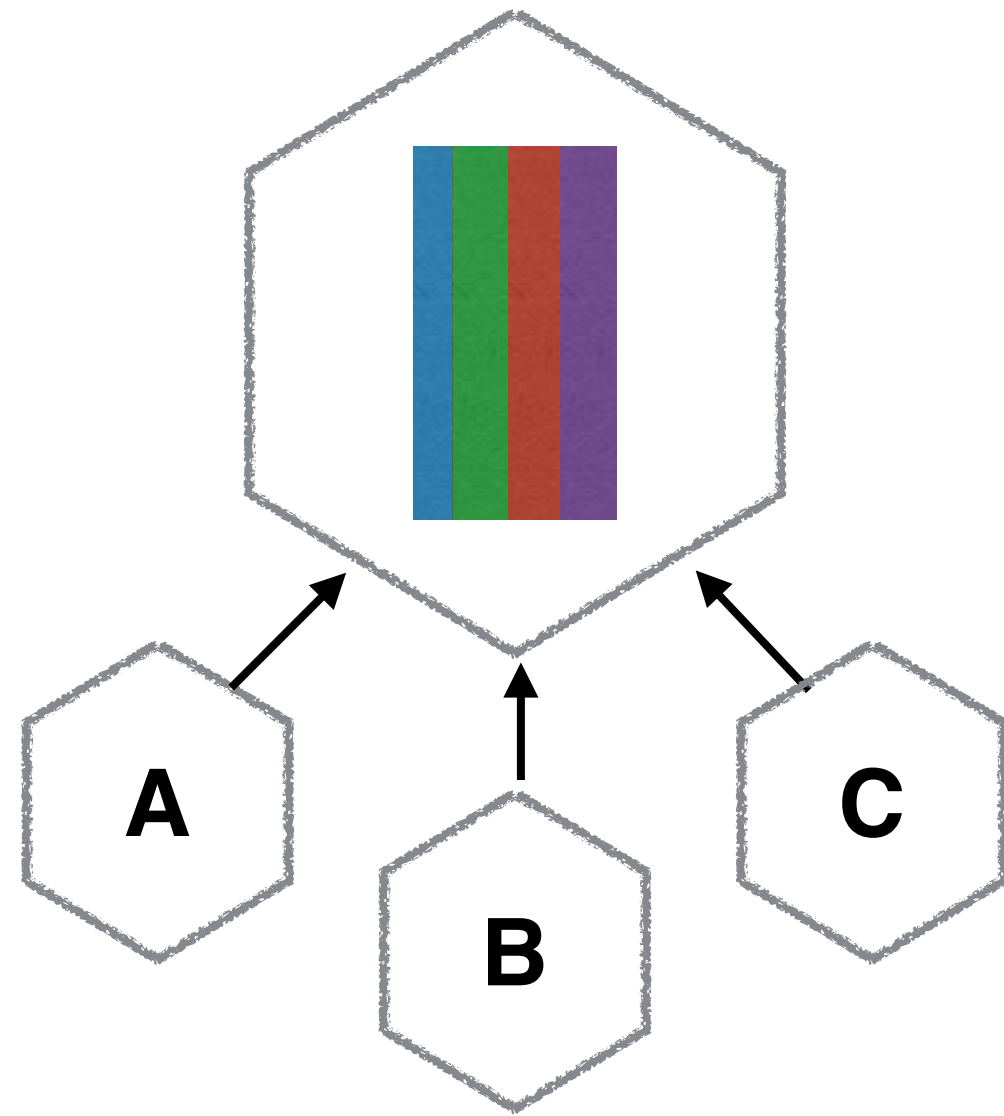

Sidecar

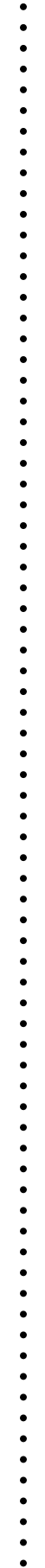

SIDECARS VS PROXIES

Local Proxy

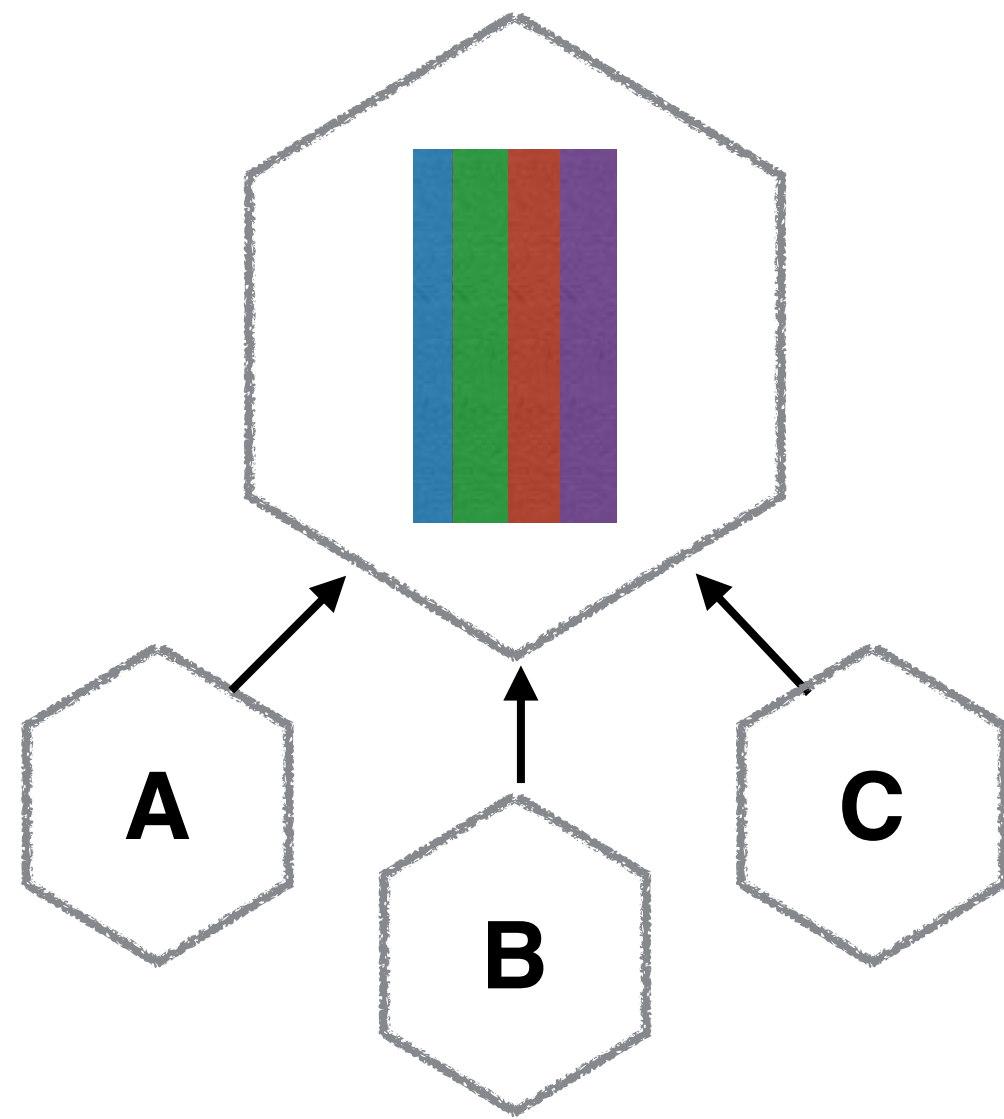

Linkerd

Sidecar

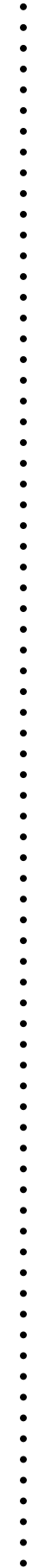

SIDECARS VS PROXIES

Local Proxy

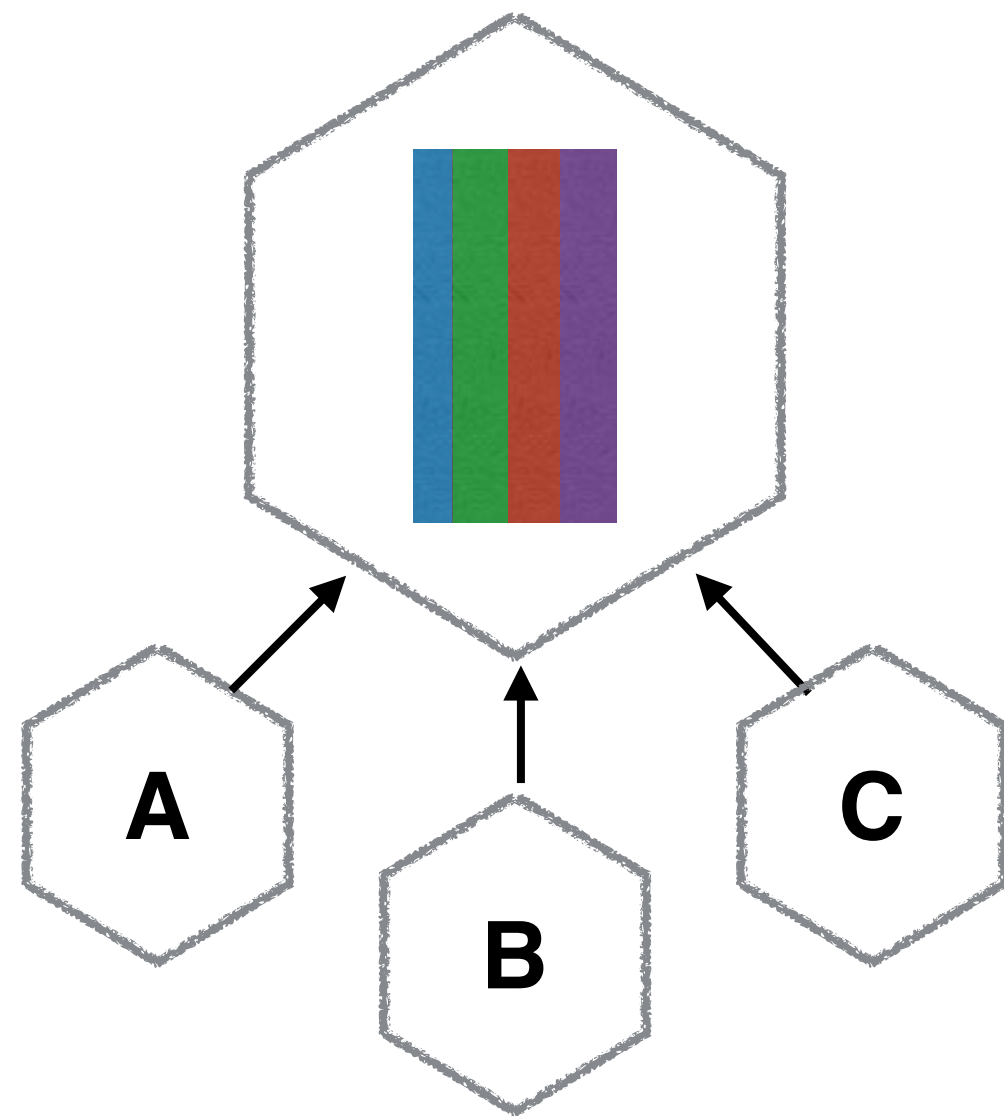

Linkerd



Sidecar

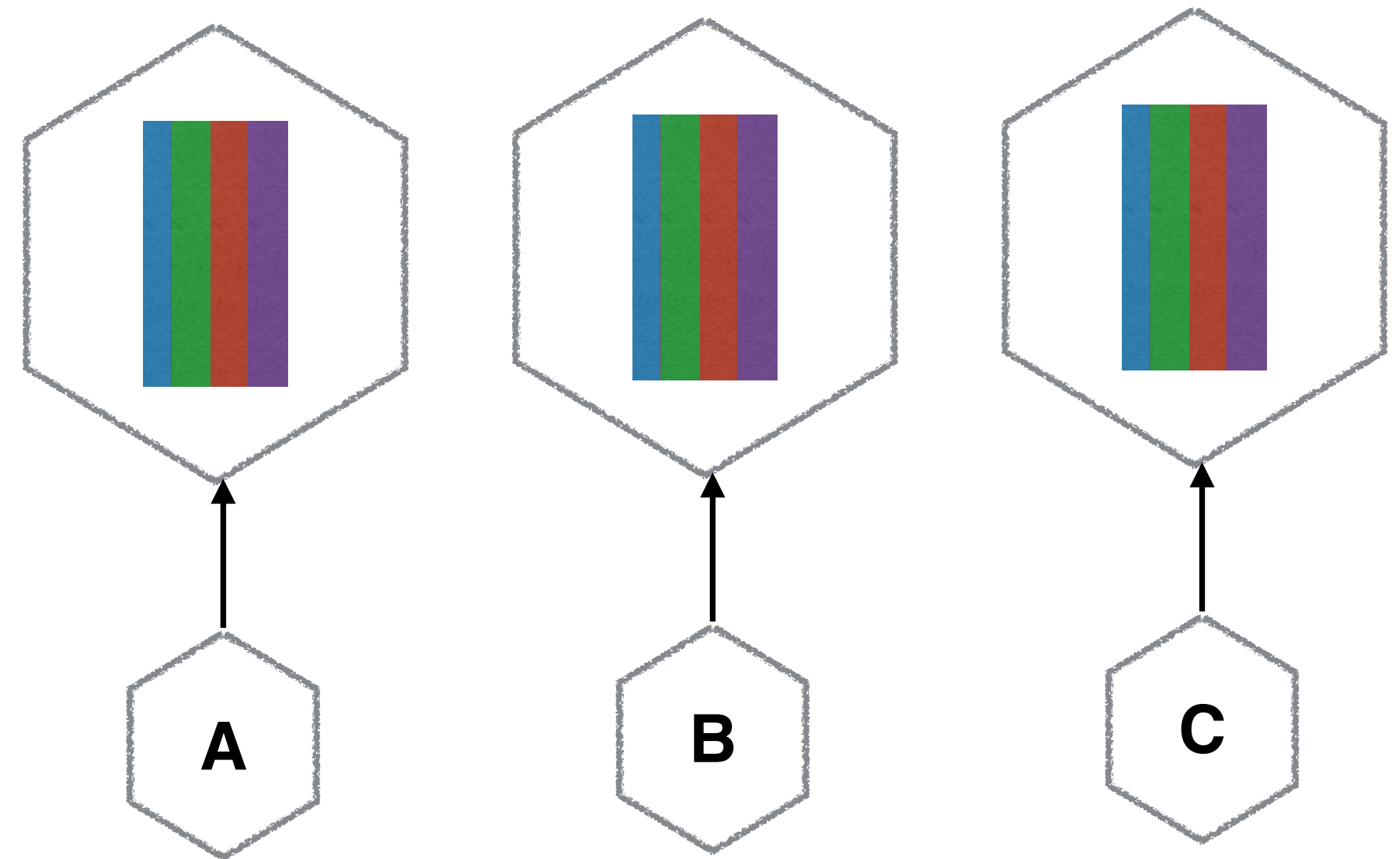

SIDECARS VS PROXIES

Local Proxy

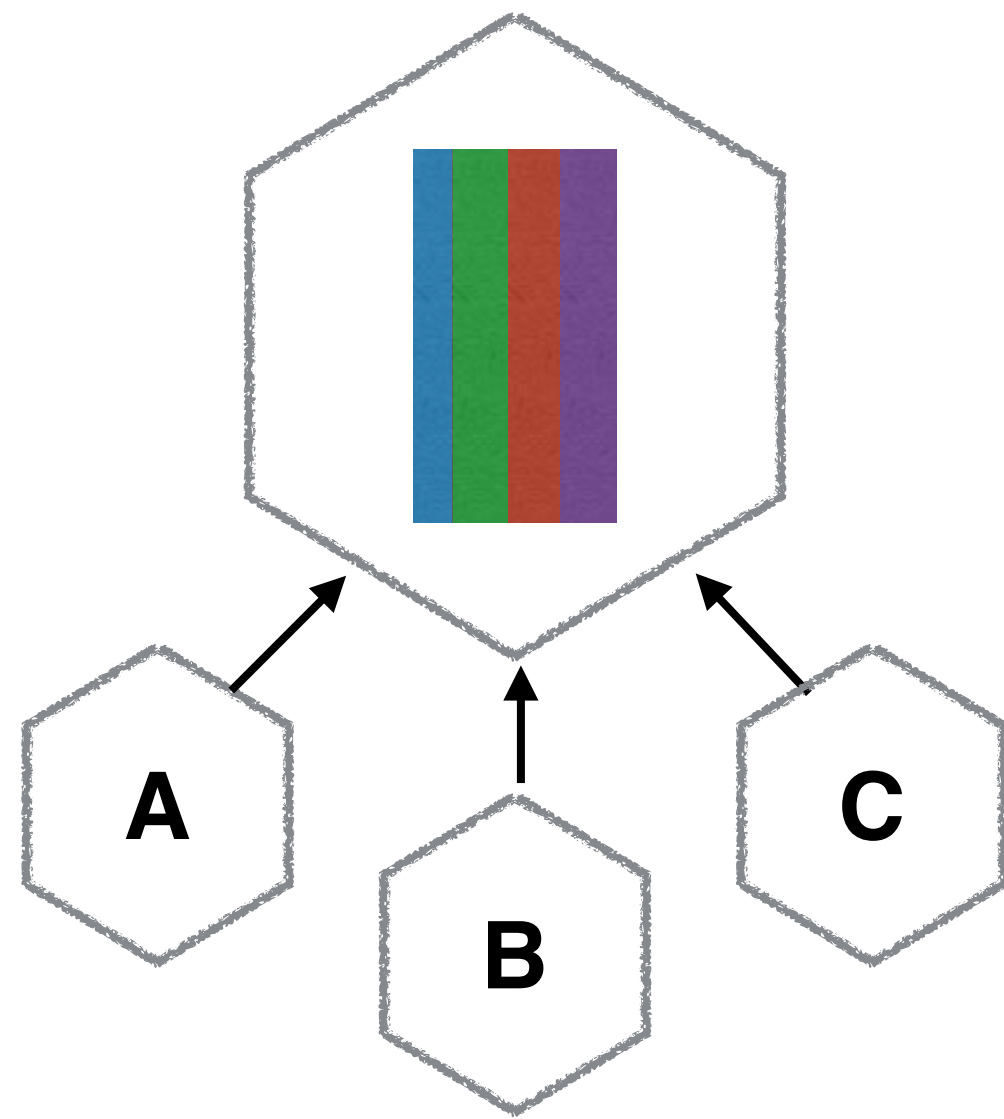

Linkerd



Sidecar

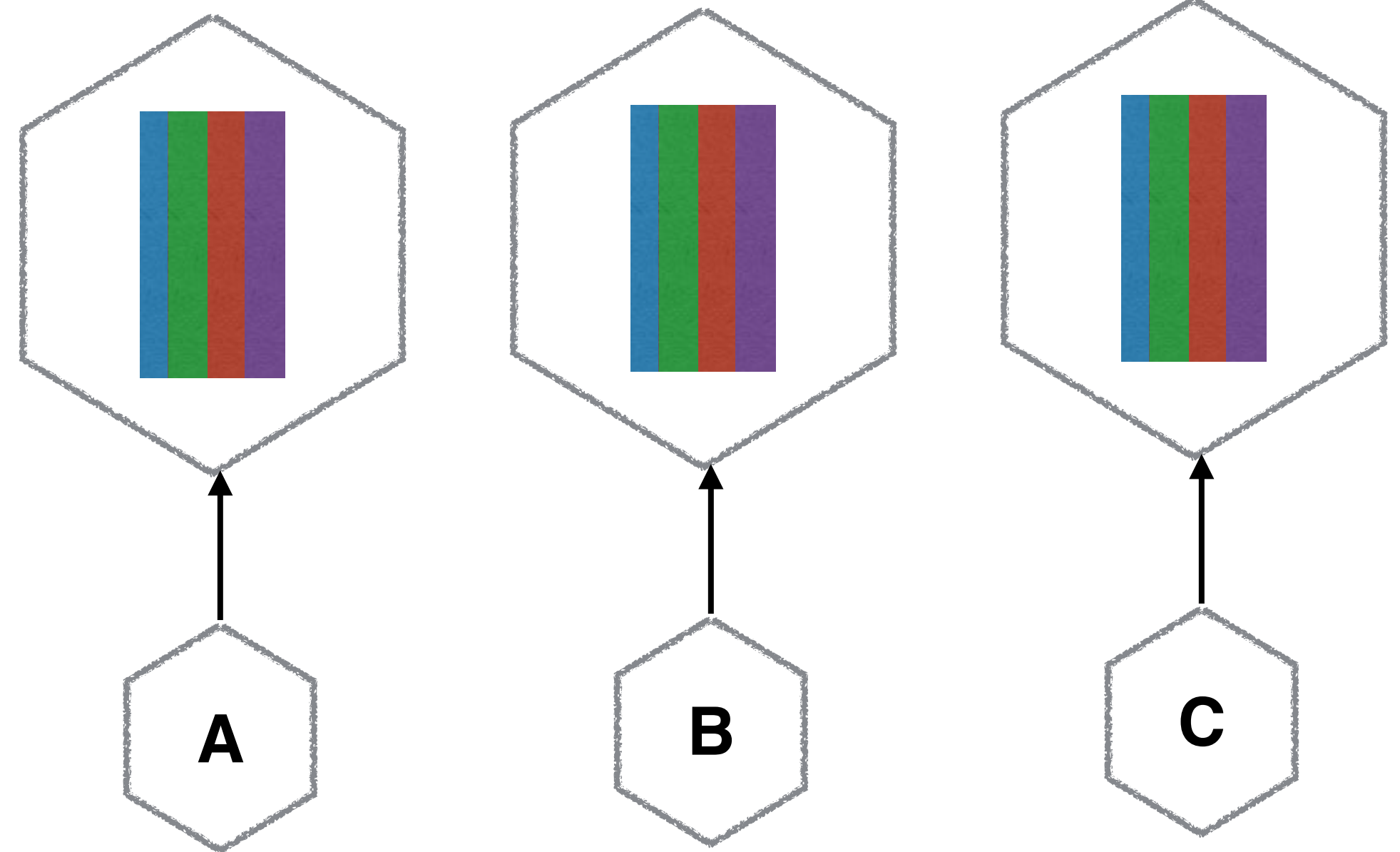

Istio

SIDECARS VS PROXIES

Local Proxy

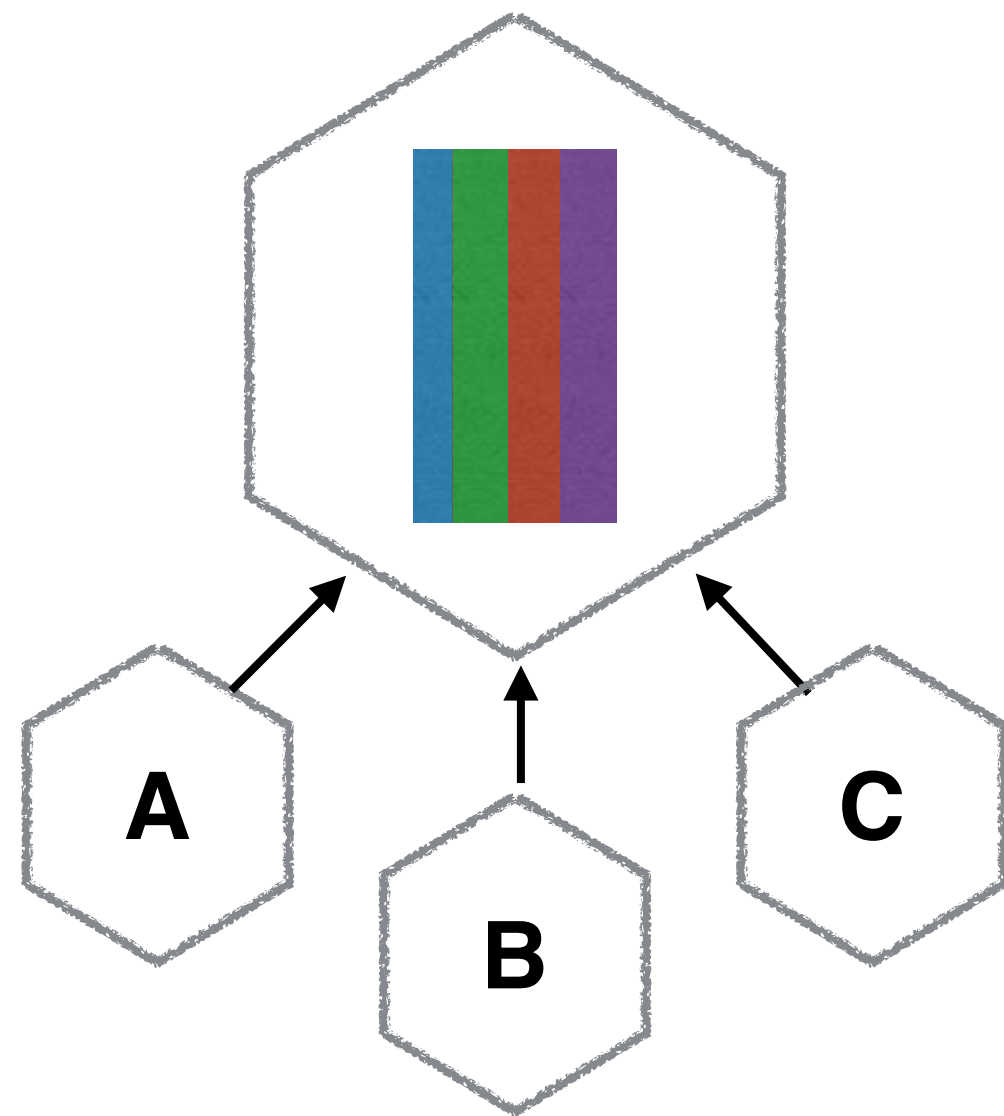

Linkerd



Sidecar

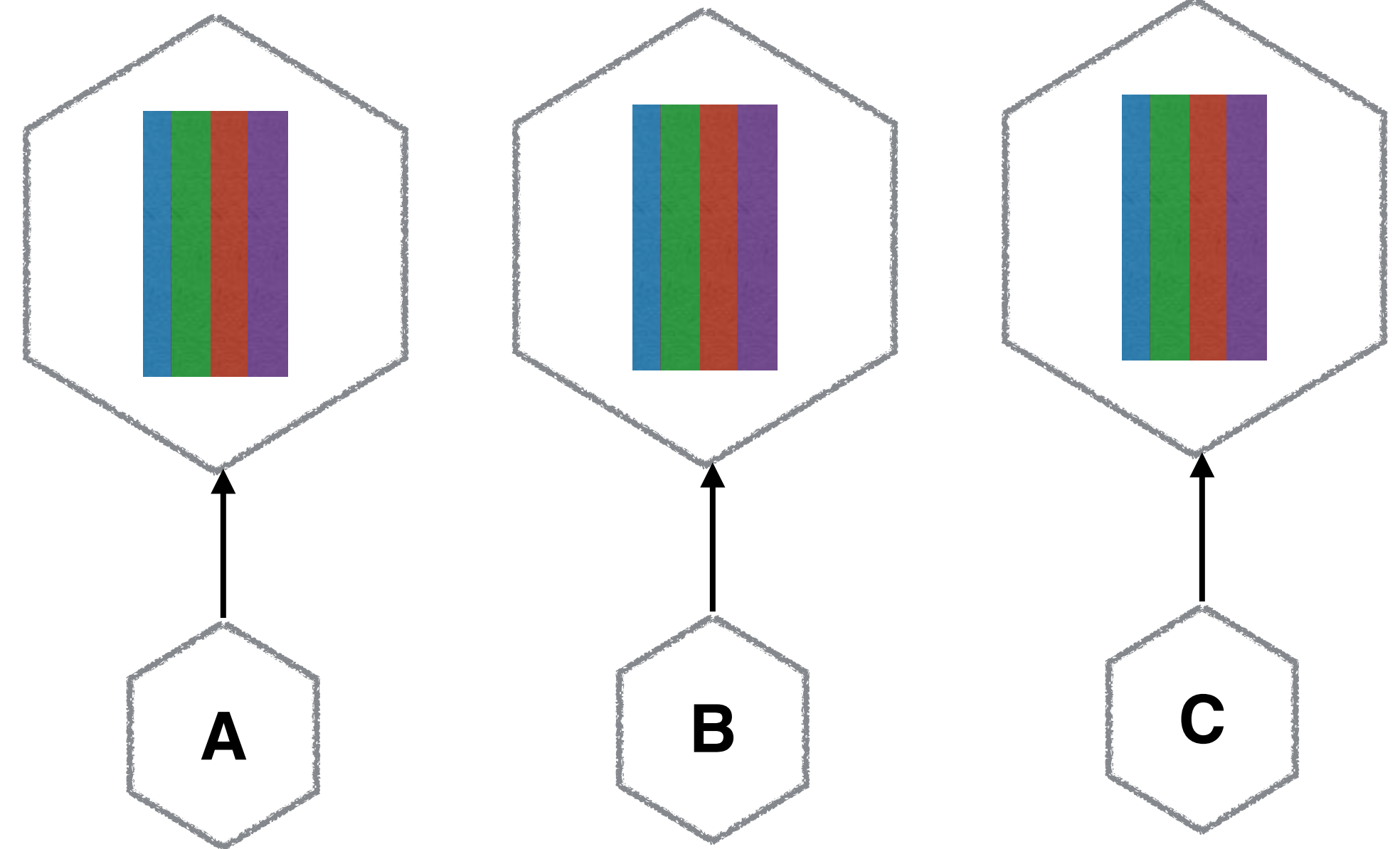

Istio



SERVICE MESH CAPABILITIES

SERVICE MESH CAPABILITIES

Load balancing

SERVICE MESH CAPABILITIES

Load balancing

Traffic Routing (blue/green deploys, canaries)

SERVICE MESH CAPABILITIES

Load balancing

Traffic Routing (blue/green deploys, canaries)

Service discovery

SERVICE MESH CAPABILITIES

Load balancing

Traffic Routing (blue/green deploys, canaries)

Service discovery

Tracing

SERVICE MESH CAPABILITIES

Load balancing

Traffic Routing (blue/green deploys, canaries)

Service discovery

Tracing

Security!

MUTUAL TLS

Mutual TLS Authentication

Overview

Istio Auth's aim is to enhance the security of microservices and their communication without requiring service code changes. It is responsible for:

- Providing each service with a strong identity that represents its role to enable interoperability across clusters and clouds
- Securing service to service communication and end-user to service communication
- Providing a key management system to automate key and certificate generation, distribution, rotation, and revocation

Architecture [↗](#)

The diagram below shows Istio Auth's architecture, which includes three primary components: identity, key management, and communication security. This diagram describes how Istio Auth is used to secure the service-to-service communication between service 'frontend' running as the service account 'frontend-team' and service 'backend' running as the service account 'backend-team'. Istio supports services running on both Kubernetes containers and VM/bare-metal machines.

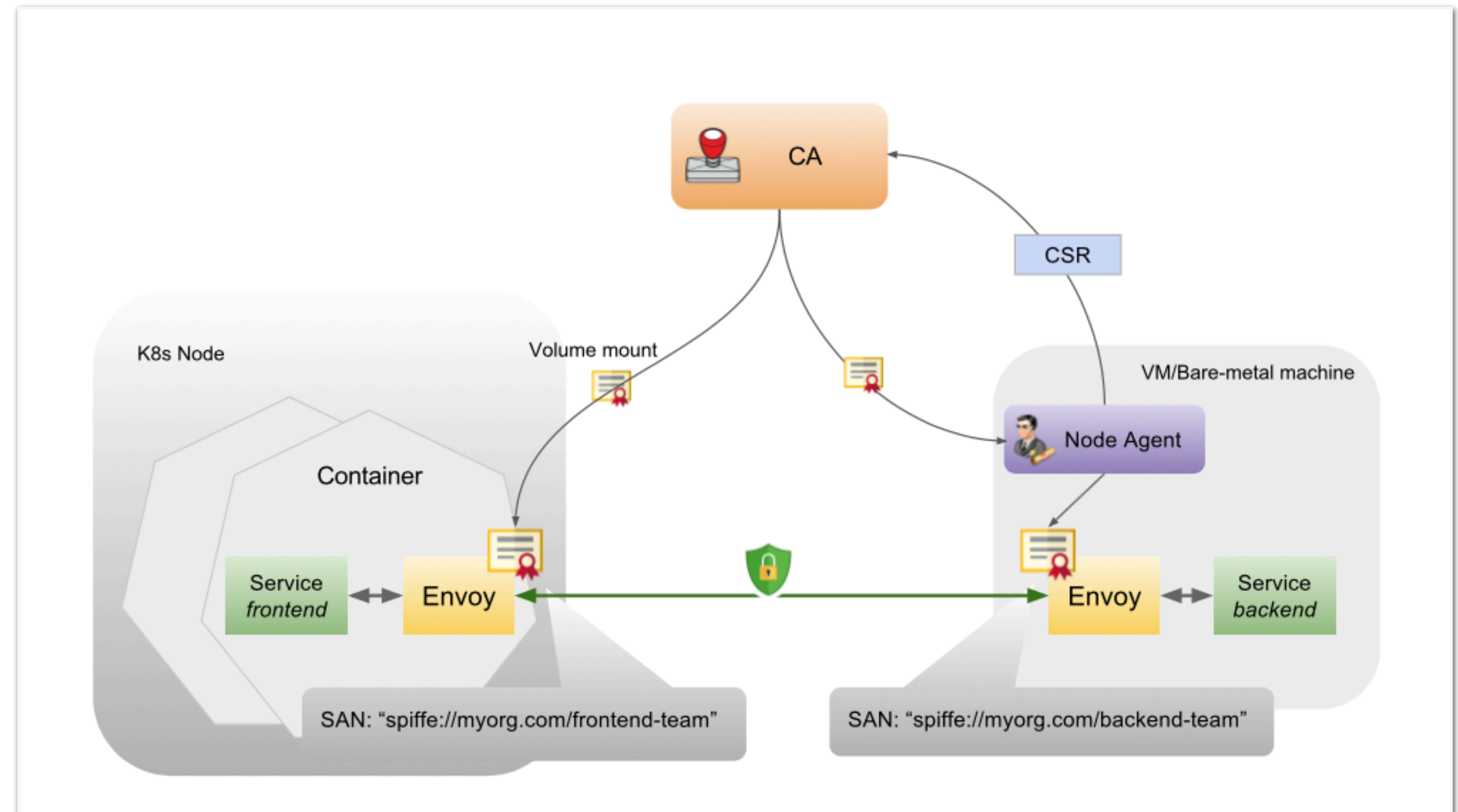

<https://istio.io/docs/concepts/security/mutual-tls.html>

Caution warranted?

SUMMARY

SUMMARY

Patching & Passwords

SUMMARY

Patching & Passwords

Storing Secrets

SUMMARY

Patching & Passwords

Storing Secrets

Transport Security

SUMMARY

Patching & Passwords

Storing Secrets

Transport Security

Authorisation

SUMMARY

Patching & Passwords

Storing Secrets

Transport Security

Authorisation

Service Meshes

THANKS!

Sam Newman. Home About **Talks** Events Writing Contact

Insecure Transit - Microservice Security.

60min Presentation

PATCHING MADNESS!

Needs patching

Video!

O'REILLY

Building Microservices

DESIGNING FINE-GRAINED SYSTEMS

Sam Newman

<http://samnewman.io/>

@samnewman